

# A GRAVITATIONAL TORQUE MICRO-GENERATOR FOR SELF-POWERED SENSING

Tzern T. Toh, Paul D. Mitcheson, Eric M. Yeatman

Department of Electrical and Electronic Engineering, Imperial College London

tzern.toh02@imperial.ac.uk

**Abstract** — A micro-generator to harvest power from continuously rotating structures is proposed and described. Experimental results are presented from a preliminary realisation based on a simple DC machine. Finally, adaptive control of this structure is discussed and modelled.

**Key Words:** energy harvesting, micro-generator

## 1 INTRODUCTION

The replacement of ambient energy harvesting to replace or supplement batteries in wireless sensors has attracted a great deal of research attention. Motion and vibration provide possible power sources, and a wide range of devices have been developed which exploit them [1]. So far, reported devices have generally used internal vibration of a proof mass in a frame, with the transduction mechanism (e.g. piezoelectric) damping the internal motion to extract power. Devices using rotation of a proof mass have also been demonstrated, but these also rely on oscillating source motion [2]. All these devices rely on interaction between the acceleration implicit in oscillations and linear or rotational inertia to generate internal forces, and thus are classed as inertial generators.

## 2 GRAVITATIONAL TORQUE GENERATORS

There are many applications where it could be desirable to mount a self-powered sensor on a rotating body, such as a turbine or pump, or within a vehicle tire. Since there is no acceleration associated with continuous motion, inertial generators in this case must rely on speed variations, or vibration associated with the rotation. However, an alternative exists: namely to use gravitational acceleration to provide the counter-force, rather than inertia. Here we report this concept, and its preliminary demonstration, to our knowledge for the first time.

DC generators provide a convenient system with which to demonstrate our new energy harvesting approach. A simple equivalent circuit is shown in Figure 1, with the generator modelled as a voltage

source and a series winding resistance, along with an external load.

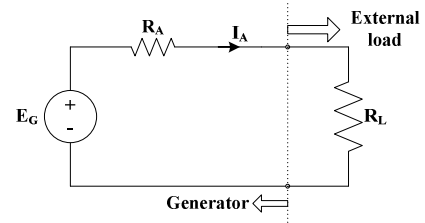

Figure 1. Equivalent circuit of DC generator.

By applying Kirchoff's Voltage Law around the circuit in Figure 1, we obtain:

$$E_G = I_A (R_A + R_L) \quad (1)$$

Where  $E_G$  is the generated voltage,  $R_A$  is the armature resistance of the motor,  $I_A$  is the current through the circuit and  $R_L$  is the load resistor [3].

$E_G$  varies with the shaft's angular velocity,  $\omega$  as:

$$E_G = K_E \omega \quad (2)$$

Where  $K_E$  is the motor constant. Hence, the electrical power,  $P_{elec}$  dissipated in  $R_L$  is:

$$P_{elec} = \frac{(K_E \omega)^2 R_L}{(R_A + R_L)^2} \quad (3)$$

The maximum  $P_{elec}$  occurs, as expected, when  $R_L = R_A$ , provided this matching condition does not impose excessive damping on the generator.

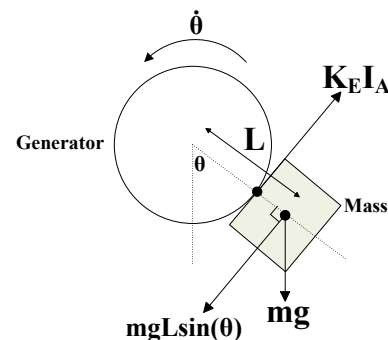

Figure 2. Torque due to the generator and mass.

The torque generated is  $T_{gen} = K_E I_A$ . In a conventional embodiment, the counter-torque is provided by anchoring the generator chassis to a

non-rotating structure, while the rotor is coupled to a source of rotation. This power cannot be produced without mechanical attachment to two structures rotating relative to each other. The benefit of our new device is that, as in the case of inertial energy harvesters, only attachment to a single point is needed. This point need only be on a rotating body, not necessarily on its axis. It is also necessary that the axis of rotation have a horizontal component. We provide the counter-torque by imbalancing the rotor or chassis with an offset mass.

By attaching such a mass to the generator's body, we have the gravitational torque,  $T_m = mgL \sin(\theta)$  with  $m$  representing the mass,  $g$  the acceleration of gravity,  $L$  the distance from the centre of the mass to the centre of the generator, and  $\theta$  the deflection angle. This leads to an expression for the net torque:

$$\text{Net Torque} = I_M \ddot{\theta} = K_E I_A - mgL \sin(\theta) \quad (4)$$

$I_M$  is the moment of inertia of the generator's stator.

The net torque determines if the mass will continue to displace itself up to the point where  $\theta$  exceeds  $90^\circ$  and the mass will flip over and continuously rotate around the generator. If we maintain  $\theta$  at an equilibrium position of  $90^\circ$ , we are then generating the maximum  $I_A$ , which leads to maximum power extraction from the generator. It can be seen that the optimal generator torque depends on speed of rotation. This device lends itself very well to adaptive optimisation, a goal proposed but to date not realised in vibrating energy harvesters.

Equation (4) forms the basis of our SPICE model, which incorporates adaptive load matching circuits that ensure maximum extraction of power in addition to preventing the mass from flipping over.

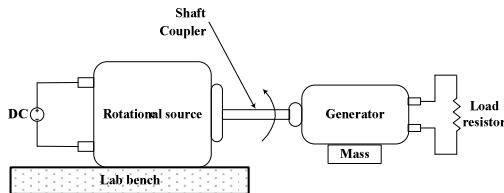

Figure 3. Experimental setup of the generator and its rotational source.

In the experiments, two DC motors were coupled together at their shafts, with one motor acting as a rotational source and the other as a generator. The driver motor was clamped onto a workbench while the generator was suspended in air. A rectangular mass was attached to the body of the generator and a load resistor,  $R_L$  was connected to the output leads of

the generator through a breadboard. The voltage drop across  $R_L$  was measured alongside the angular velocity of the coupled shaft by means of an optical tachometer.

Table 1. Experimental values

Variable	Value
m	20 g
g	$9.81 \text{ ms}^{-2}$
L	19.85 mm
$K_E$	$2.59 \times 10^{-3} \text{ V}\cdot\text{s}/\text{rad}$
$R_A$	1.1 $\Omega$
$R_L$	0.5 $\Omega$ , 1.2 $\Omega$ , 5.1 $\Omega$ , 10 $\Omega$

Figure 4 demonstrates the higher power achieved with a matched load. However, as shown in Figure 5, for speeds above 9000 rpm the matched load produces excessive torque, so that the generator flips over. In that case the optimal load is the one that maximises power without flipping over, as in (4).

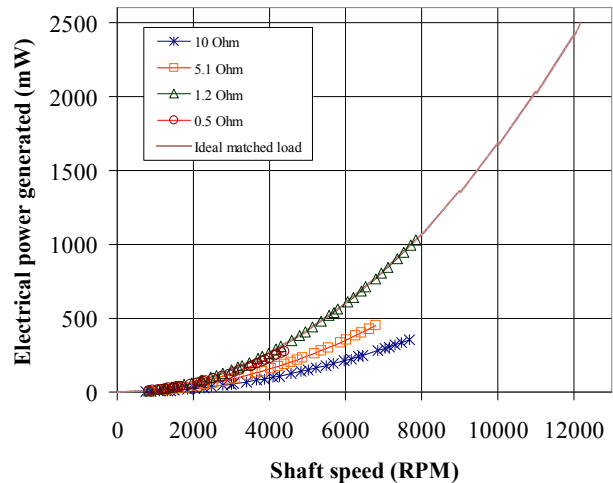

Figure 4. Experimental measurements of electrical power generated for different load resistances.

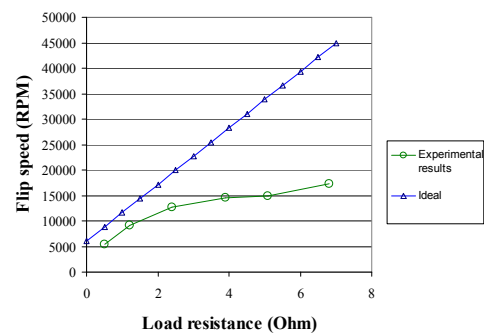

Figure 5. Speed at which the angle of deflection exceeds  $90^\circ$ ; for armature resistance of 1.1  $\Omega$ .

### 3 IMPEDANCE MATCHING

The primary requirement for the circuitry connected to the generator is that the input impedance of that circuitry,  $R_{IN}$ , is matched to the generator's armature resistance. This load matching can be realized by connecting a switch-mode power converter between the generator and the load. The impedance looking into the input of a power converter can be thought of as a referred version of the load resistance connected to the converter, in a similar way that impedances can be referred across a transformer. This system is shown in Figure 6. As the device being powered by this system,  $R_{LOAD}$  (probably a miniature sensor), will likely have a much higher resistance than the armature, the power converter must be capable of making its input impedance less than its load impedance so that  $R_{IN}$  can match  $R_A$ .

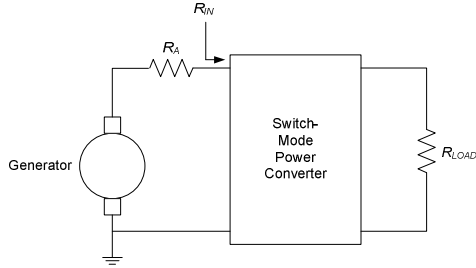

Figure 6. Power converter interface for optimal power transfer from the generator.

In steady state, the input impedance of a Boost converter depends on the load resistance at its output and its duty cycle,  $\delta$ , by:

$$R_{IN} = R_{LOAD} (1 - \delta)^2 \quad (5)$$

Thus the boost converter is suitable for this impedance matching task. A control loop was wrapped around the boost converter to keep the input impedance constant by measuring the input voltage and calculating a current demand for that input voltage.

### 4 STORAGE

It is crucial that the generator can power external circuits that run off a constant voltage. The boost converter proposed above cannot run in a voltage control mode because it is required to impedance match its input to the armature resistance and thus takes in variable power in depending on the power being generated. We have thus designed a Buck converter that maintains a constant output voltage across a load resistance through a voltage control

loop. This converter is attached in parallel with a storage capacitor to the output of the boost converter [4]. The capacitor stores energy when the generator produces more power than is required by the load and discharges when the generator is not generating sufficient power to meet the load demand. The voltage control loop measures the voltage across  $R_L$  and continuously compares it with a designated reference voltage in order to hold the voltage at that reference value.

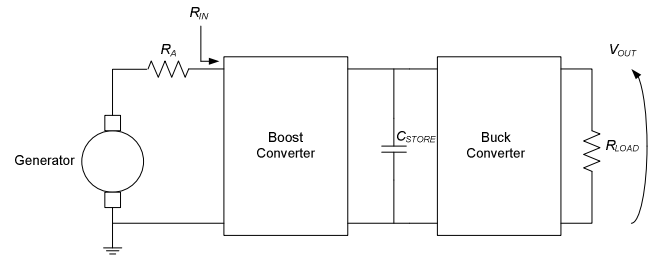

Figure 7. Power Converter system for impedance matching and output voltage control

A restriction was placed on the maximum current that the boost power converter could draw from the generator in order to limit the torque and prevent the stator from flipping over. This was done by placing a limit on the maximum input current demand for the boost converter. The control loop demand reference is set to a proportion of the maximum permissible current in the generator before flipping, so that the instability is not close to being reached. The limit of the armature current before flipping is given by:

$$I_A(max) = \frac{mgL}{K_E} \quad (6)$$

It is not sensible to have the power converter meticulously track  $I_A(max)$  because the momentum of the mass may cause it to flip over. The error between the measured and demand value of  $I_A$  is used to generate a pulse-width-modulated (PWM) signal, which controls the duty cycle,  $\delta$  of the Boost power converter.

### 5 SPICE IMPLEMENTATION

The values of every variable were represented by voltages in our SPICE simulations. Angular velocity has the units of radians per second. The mechanical generator was modelled based on its electrical equivalent circuit and a voltage ramp was used to characterize the rotational source. In our simulations, a reference voltage of 5V across  $R_L$  was what the output from the Buck converter should track. Figure 8 depicts our SPICE circuit model.

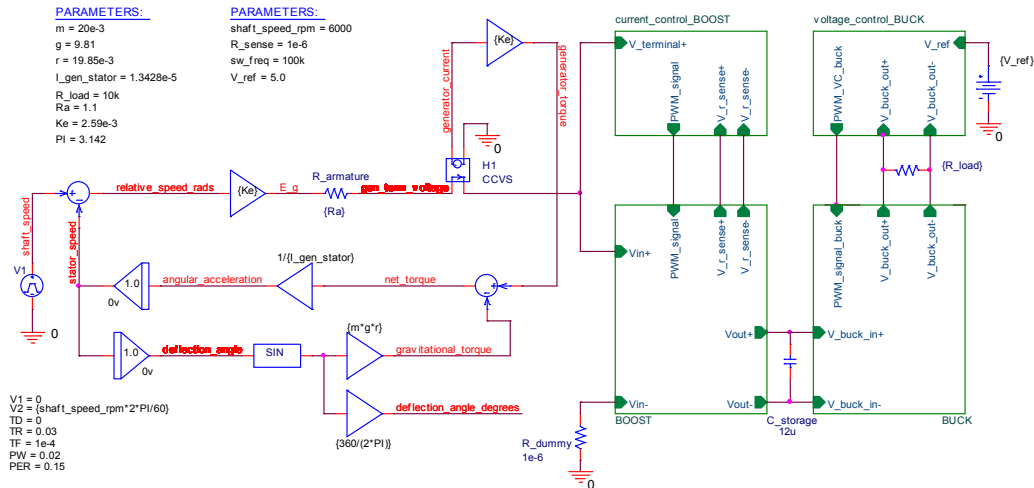

Figure 8. SPICE model of the generator with adaptive impedance matching circuits.

## 6 SIMULATION RESULTS

The shaft speed was ramped up to 6000 revolutions per minute (RPM) and sustained at that value before instantly decreasing to zero. The graphs below are: a) shaft speed [RPM], b) voltage across storage capacitor [V], c) voltage across  $R_L$  [V], d)  $R_{IN}$  at Boost converter [ $\Omega$ ] and e) deflection angle [ $^\circ$ ].

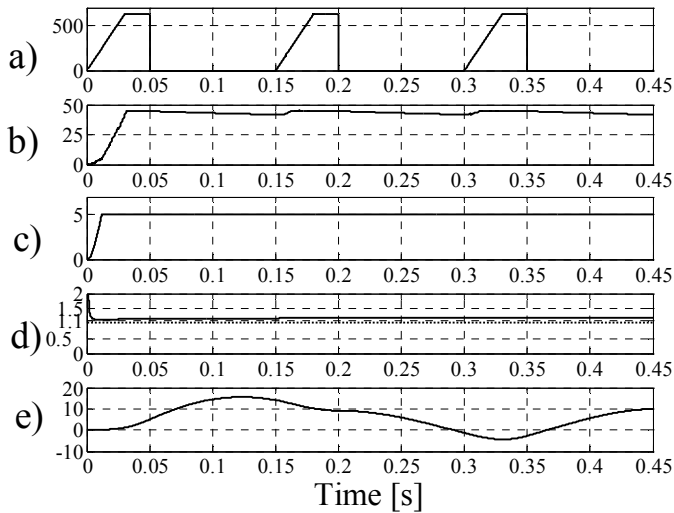

Figure 9. SPICE simulation of the model -  $R_L = 10 \text{ k}\Omega$ ,  $R_A = 1.1 \Omega$ .

In Figure 9, the shaft speed gradually ramps up and stays constant before instantly decreasing to zero. During this time, the voltage across the storage capacitor increases and the Buck converter limits the voltage across  $R_L$  at the reference level of 5V. The capacitor then discharges when the shaft stops, to maintain a 5V drop across  $R_L$ . Throughout this time, the input impedance of the Boost converter remains

very close to  $R_A$  which results in maximum power transfer from the generator to the load. The angle of deflection never goes past  $90^\circ$  due to the current control loop employed here.

## 7 CONCLUSIONS

The concept of continuous rotational energy harvesting has been demonstrated with both a simple experimental setup and an integrated electro-mechanical simulation, where switch mode power converters provide an optimised interface to the harvesting generator and at the same time regulate the output voltage. We aim to integrate this work into hardware using a PIC-microcontroller which interfaces a microturbine [5] with the adaptive load matching circuits.

## REFERENCES

- [1] Paul D. Mitcheson, et al., "Architectures for Vibration-Driven Micropower Generators," Journal of Microelectromechanical Systems, vol. 13, pp. 429 - 440, 2004.
- [2] Eric M. Yeatman, "Energy Scavenging from Motion Using Rotating and Gyroscopic Proof," submitted to Journal of Mechanical Engineering Science, 2007
- [3] USA Electro-Craft Corporation, DC Motors, Speed Controls, Servo Systems. Oxford, New York, Toronto, Sydney, Paris, Frankfurt, Pergamon Press Ltd. 2-7 - 2-96, 1977.
- [4] R Dhulst, et al. CMOS Buck-Boost Power Processing Circuitry for PowerMEMS Generators, Power MEMS, Berkeley, USA, pp. 215 - 218, 2006.
- [5] Andrew S. Holmes, et al., "Axial-Flux Permanent Magnet Machines for Micropower Generation," Journal of Microelectromechanical Systems, vol. 14, pp. 54 - 62, 2005.