

SOME ANALYTICAL APPLICATIONS OF
ELECTROGENERATED CHEMILUMINESCENCE

A Thesis Submitted for the Degree of Doctor of

Philosophy of the University of London

Peter Neal Keliher, A.B., M.Sc., D.I.C.

Chemistry Department
Imperial College of Science and Technology
South Kensington
London, S.W. 7

October, 1969

ABSTRACT

Electrogenerated chemiluminescence (ECL) has been studied for a large number of polynuclear aromatic hydrocarbons and related substances using tetra-n-butyl ammonium perchlorate (TBAP) as supporting electrolyte with dimethyl formamide (DMF) as solvent. A simple device to allow rapid screening of compounds for possible ECL is described. The control of all of the necessary parameters (sweep rate, potential, wave-form, etc.) for any quantitative assessment of ECL is discussed and the construction of reliable equipment to study the phenomenon is described. This included the construction of a potentiostat incorporating operational amplifier circuitry in conjunction with a three electrode cell configuration set into a normal spectrofluorimeter size cell. A dual-beam oscilloscope was used to allow the simultaneous monitoring of current-potential (cyclic voltammetry) relationships in the electrochemical cell and light output data from the working electrode, a platinum spiral.

The spectra of 51 compounds is presented and these spectra are contrasted with pre- and post- electrolysis fluorescence spectra measured under similar conditions. Analytical considerations are discussed. Concentration-intensity relationships are noted for

several compounds. The effect of all of the various parameters on the ECL of solution mixtures is given. It is shown that certain cases exist where compounds can be distinguished by ECL emission where it is more difficult by fluorescence.

DEDICATION

To My Parents and the B.R.

ACKNOWLEDGEMENTS

I would like to express my thanks to Professor T.S. West, D.Sc. for providing facilities at Imperial College and for his encouragement during the preparation of this thesis. I would also like to thank my immediate supervisors, Dr. B. Fleet and Dr. G.F. Kirkbright, for their guidance during the preparation of this thesis.

Thanks are due to Mr. D. Alger who constructed the photomultiplier and housing units mentioned in Chapter Two. Thanks are also due to Dr. R. Thornton of the British American Tobacco Co. who provided small samples of most of the polynuclear aromatic hydrocarbons treated in this thesis. Several other samples were provided by the Tobacco Research Council. I would also like to thank the Tobacco Research Council for the award of a Research Assistantship and a grant used to purchase the equipment required for the construction of the ECL apparatus.

Finally I would like to thank my colleagues, especially Mr. C.J. Pickford, for many helpful discussions and my wife, Bonnie, for her encouragement.

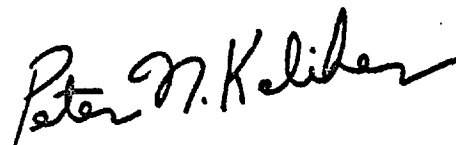

Peter N. Keliber

CONTENTS

	page
Title	1
Abstract	2
Dedication	4
Acknowledgements	5
Contents	6
Abbreviations	8
Presentation of Figures	9
<u>Chapter One</u>	Introduction 10
<u>Chapter Two</u>	Experimental Procedure 47
<u>Chapter Three</u>	ECL Spectral Data / 86
<u>Chapter Four</u>	Analytical Considerations 122
<u>Chapter Five</u>	Conclusions and Suggestions 140 For Future Work

	page
References	142
Publications	148

ABBREVIATIONS

A ⁺	Electron acceptor
AN	Acetonitrile
DBA	Dibenz anthracene (isomer designated)
DBP	Dibenz pyrene (isomer designated)
DPA	Diphenyl anthracene (refers to 9,10 isomer)
DPOT	1,8- Diphenyl- 1,3,5,7- octatetraene
e	electron
ECL	Electrogenerated chemiluminescence, electrochemiluminescence
R	Aromatic compound
₁ R [*]	Excited singlet
₃ R [*]	Excited triplet
₁ R ₂ [*]	Excimer
TBAP	Tetra-n-butyl ammonium perchlorate
TEAB	Tetra ethyl ammonium bromide
TEAP	Tetra ethyl ammonium perchlorate
TMPD	Tetramethyl-p- phenylene diamine
TPCDD	1,2,3,4- Tetraphenyl- 1,3,- cyclopentadiene
TPIBF	Tetraphenyl isobenzofuran (isomer designated)
WB	Wurster's Blue

PRESENTATION OF FIGURES

"A" refers to 

"B" refers to 

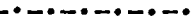
"C" refers to 

"D" refers to 

For the spectra presented in Figures 35-86, "A" refers to the ECL spectra, "B" to the pre-electrolysis fluorescence spectra, and "C" to the post-electrolysis fluorescence spectra, at the same exciting wavelength.

CHAPTER ONEINTRODUCTION1.1 Luminescence

The emission of light from solids, liquids (including solutions), or gases can be stimulated in a variety of ways. Many of these ways are of interest from the point of view of their analytical utility and are currently being investigated in many laboratories. Bodies which are self-luminous solely by virtue of their high temperature are referred to as incandescent. Luminescence is the term used to refer to all other types of light emission. Systems which are luminescent are continuously losing energy and if the light emission is to continue indefinitely, energy must be applied to the system. The source of energy for radioluminescence is the radioactive material incorporated in, for example, the luminous dial of a clock. Triboluminescence refers to the light energy produced when certain crystals are crushed, sonoluminescence is produced in liquids when exposed to intense sound waves. For photoluminescence, the energy is provided by the absorption of visible or ultra-violet light. Fluorescence and phosphorescence are both forms of photoluminescence.

Chemiluminescence occurs when a chemical reaction produces an electronically excited species, which emits light on its return to the ground state. The fascination of man for this phenomenon is reflected in ancient writings and in the early scientific literature¹. These observations were concerned for the most part with luminescing living organisms found among plants and animals. These would include the firefly, luminous bacteria and protozoa, the marine fireworm, and a number of unicellular organisms (the dinoflagellates) which are often the cause of the beautiful "phosphorescence" and "red tides" found in the seas. These phenomena are sometimes referred to as bioluminescence.

1.2 Nomenclature

Electrochemiluminescence (or electrogenerated chemiluminescence) refers to the production of light in the vicinity of an electrode during electrolysis of a solution. This is now distinguished from the term electroluminescence which refers to light produced by voltages across semiconductors such as gallium arsenide. Although electroluminescence is still sometimes used in the literature where electrochemiluminescence is meant, in this thesis the term electrochemiluminescence (ECL) will be used exclusively.

1.3 Historical

Electrochemiluminescence at mercury and other electrodes was first

noted by Bancroft (1914) in the electrolysis of halides². Harvey found ECL at the anode during the electrolysis of luminol³. A bright emission appeared at 2.8 V and 0.0005 amperes which lasted for some time in a stirred solution. In an unstirred solution, a bright flash which dimmed quickly appeared at 2.8 V and a steady ECL was seen at 0.5 V. This Harvey considered due to oxidation of luminol by the film of active oxygen. Harvey did not use the term electrochemiluminescence to describe the phenomenon but suggested galvanoluminescence. Harvey also noted ECL at a metallic cathode when solutions of oxyluciferin and luciferase were subject to potentials of about 1.5 V. In this case it was considered that the nascent hydrogen appearing at the cathode reduced the oxyluciferin to luciferin in a layer next to the electrode and the luciferin then reoxidised in a contiguous layer containing oxygen and luciferase. Luciferin and luciferase are the luminescent substances of luminous animals, such as the firefly, light appearing when luciferin oxidises to oxyluciferin in the presence of luciferase. There were also reports about this time of ECL resulting from the electrolysis of nonaqueous solutions such as Grignard reagents in ether⁴ but the conditions of these experiments were not very well defined and they were not pursued further.

The first quantitative study of an electrochemiluminescent phenomenon was by a Russian group, Shlyapintokh, Postnikov, Karpuklin, and

Vertil'nyi in 1963⁵. They noted ECL during the electrolysis of 0.1 N NaOH containing small amounts of a fluorescent substance (fluorescein or eosin) at smooth platinum electrodes. The ECL appeared at the anode only, and the intensity was measured at an applied potential of 30 V. This group also investigated the effect of electrolysis using square wave pulses of alternating intensity. They observed that at the instant of passing from the cathodic to anodic portion of the wave, the intensity of emission rose suddenly and then fell to a steady value. It was suggested that this was due to a combination of a reduction product with an oxidation product. This hypothesis was borne out by using positive pulses only. No intensity increase was noted at the instant of application of the pulse, i.e. the increase in intensity depended in some way on the products of the negative pulse.

Using variations in square wave frequency it was discovered that at higher frequencies a steady state concentration did not have time to become established, and at frequencies over 0.5 - 0.6 Hz, no increase in intensity of the cathodic-anodic ECL over the simple anodic ECL could be observed. It was further ascertained that the time necessary for the establishment of equilibrium was about ten seconds. When frequencies greater than 0.6 Hz were employed, the ECL intensity fell below that observed for simple anodic electrolysis.

In 1964, Hercules⁶ and Visco and Chandross⁷ independently reported strong ECL when a series of polynuclear hydrocarbons were electrolysed in acetonitrile (AN) or dimethylformamide (DMF) with tetraethyl ammonium salts used as supporting electrolytes. Hercules used three different arrangements of electrodes:

- 1) a single platinum working electrode with an external counter electrode separated from the solution by a fritted glass disc of fine porosity,
- 2) two platinum foil electrodes separated from each other by about 1 cm,
- 3) two concentric cylindrical electrodes, the interior one a platinum rod (2.5 mm in diameter) and the exterior one constructed from 52 mesh platinum gauze 6 mm in diameter.

Studies were carried out by

- 1) passing a current through the cell (without stirring the solution) for a given period of time and then quickly reversing the direction of current flow,
- 2) by applying a constant D.C. voltage, both with and without stirring,
- 3) by applying an A.C. square wave, both with and without stirring.

The current reversal technique with a single electrode was used. A current of 3 to 10 ma was passed through the cell for about ten seconds and then the direction of current flow was reversed. By this procedure the cathodically produced species was generated in the vicinity of the anodically produced species and vice-versa. Under these conditions emission occurred as a glow covering the electrode and extending about 0.5 to 1.0 mm into solution above the electrode surface. There was a delay of about 1 to 2 seconds between switching the current flow and observing the emission. The emission rose to a maximum intensity in about three seconds and then fell quickly. When the solution was stirred, streaming of emission from the electrode into solution (about 1 cm) was observed. Generally, the ECL was more intense on switching the electrode from positive to negative than from negative to positive.

When two square platinum electrodes were used and the solution vigorously stirred, the ECL was observed continuously in the vicinity of the cathode, and it was sufficiently bright for some compounds (notably rubrene) that it was visible in dim room light. The square wave alternating current produced a flashing effect alternatively at the two electrodes and could excite ECL up to a frequency of ten cycles per second for rubrene. When concentric cylindrical electrodes were used with 3-4 V D.C., a continuous emission was observed even when the solution was not stirred, diffusion being sufficient to mix the reacting species.

Hercules deduced some characteristics of the electrochemiluminescent reactions from simple experiments. The hydrocarbon was essential for the ECL since no emission was observed at the same current densities when only supporting electrolyte and solvent were used. It was also determined that anodically produced bromine did not participate in the light producing reaction as ECL was observed with both tetra-ethylammonium perchlorate (TEAP) and tetra-ethylammonium bromide (TEAB) as supporting electrolytes. Also, allowing a dilute bromine solution to flow over the cathode during electrolysis did not produce emission. Because of the delayed response encountered in the current-reversal experiments and the observation of streams of emission in stirred solutions, ECL is not produced at the electrode surface. In stirred solutions emission was observed only in the vicinity of the cathode and Hercules deduced from this that the more stable of the two species was generated at the anode, i.e. it was a cation. Oxygen was found to show a pronounced quenching effect on the emission, indicating the participation of free radicals. Water had no effect on the emission, at least in small quantities. The correlation between colour of electrochemiluminescence and normal fluorescence indicated that the lowest singlet state of the hydrocarbon was the emitting species. The results obtained by Hercules are shown in Table 1.

TABLE 1

Aromatic hydrocarbons showing chemiluminescence produced by electrochemically generated species.

The hydrocarbon concentrations were 10^{-3} M. Supporting electrolyte concentrations were 0.1 or 0.01M

AROMATIC HYDROCARBON	SOLVENT	ELECTROLYTE	ECL COLOUR	FLUORESCENCE COLOUR
Anthracene	AN	TEAB	Blue-white (w)	Blue-violet
Chrysene	AN	TEAB	Blue-white (m)	Blue-violet
Chrysene	DMF	TEAP	Blue-white (m)	Blue-violet
Pyrene	DMF	TEAB	Blue-white (s)	Blue
Naphthacene	DMF	TEAB	Green (s)	Green
Perylene	DMF	TEAP	Blue (s)	Blue
Perylene	AN	TEAB	Blue (s)	Blue
Perylene	DMF	TEAB	Blue (s)	Blue
Coronene	DMF	TEAB	Blue (m)	Blue
Rubrene	DMF	TEAB	Orange-red (vs)	Orange-red
Decacyclene	DMF	TEAB	Green (w)	Green
1,2,5,6 - Dibenzanthracene	DMF	TEAB	Blue-violet (m)	Violet

Emission code: w = weak emission; m = moderate intensity;

s = strong emission; vs = very strong emission.

1.4 Excited States

At this stage it would be well to discuss what is meant by the singlet state and to distinguish it from the triplet state.

In the ground state of unsaturated organic compounds the orbitals of lowest energy are each occupied by two π electrons with anti-parallel spins.

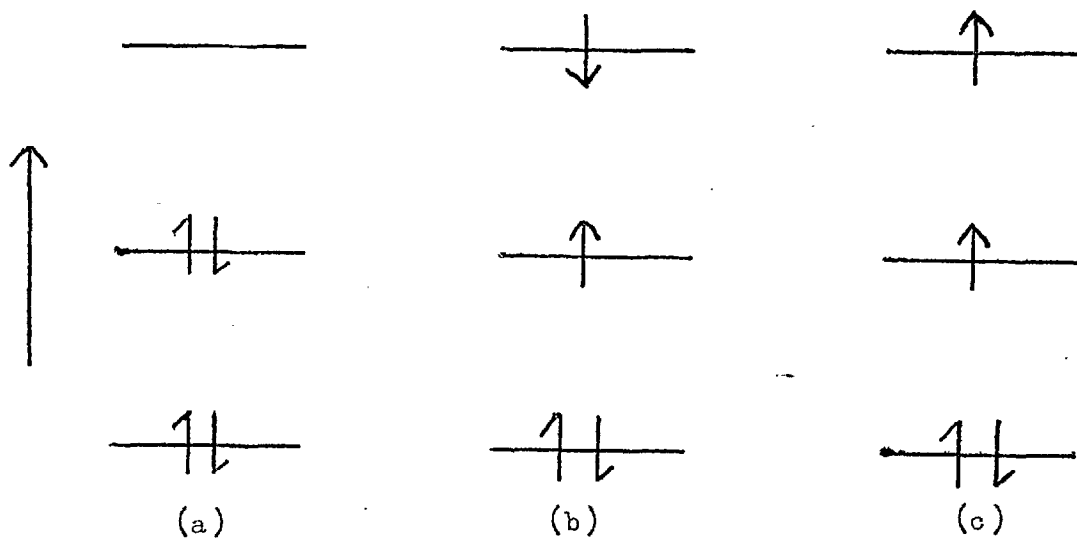

FIGURE 1

Molecular orbital scheme for a singlet ground state (a); a singlet excited state (b); and a triplet excited state (c).

The excited states arise from the promotion of an electron from the highest occupied orbital to one that is unoccupied. The spin angular momenta of the two electrons that are now in singly occupied orbitals are no longer restricted by the Pauli principle and their spins may therefore be antiparallel (Figure 1b) or parallel (Figure 1c). The state represented by Figure 1b is described as a singlet state and that represented by Figure 1c is described as a triplet state. Both of these terms are derived from classical atomic spectroscopy.

It has earlier been stated that fluorescence and phosphorescence are both examples of photoluminescence. An observational distinction may be made, however, in the lifetime of the emission after excitation has ceased. Fluorescence is usually an almost instantaneous process, occurring within about 10^{-8} seconds while phosphorescence may have a lifetime of up to several seconds. A more fundamental distinction, however, is in the form of the light emission. Consider Figure 2. Fluorescence occurs with a singlet-singlet transition from the first excited state S_1 to the ground state S_0 . Fluorescence involves the absorption and subsequent re-emission of light, generally at a longer wavelength. When light is absorbed, a molecule is raised to one of its electronically excited levels. Almost all molecules then drop back very quickly (ca. 10^{-12} seconds) into the lowest vibrational level of the upper excited state, from which a proportion of the excited molecules may then return to the ground state with the emission of fluorescence.

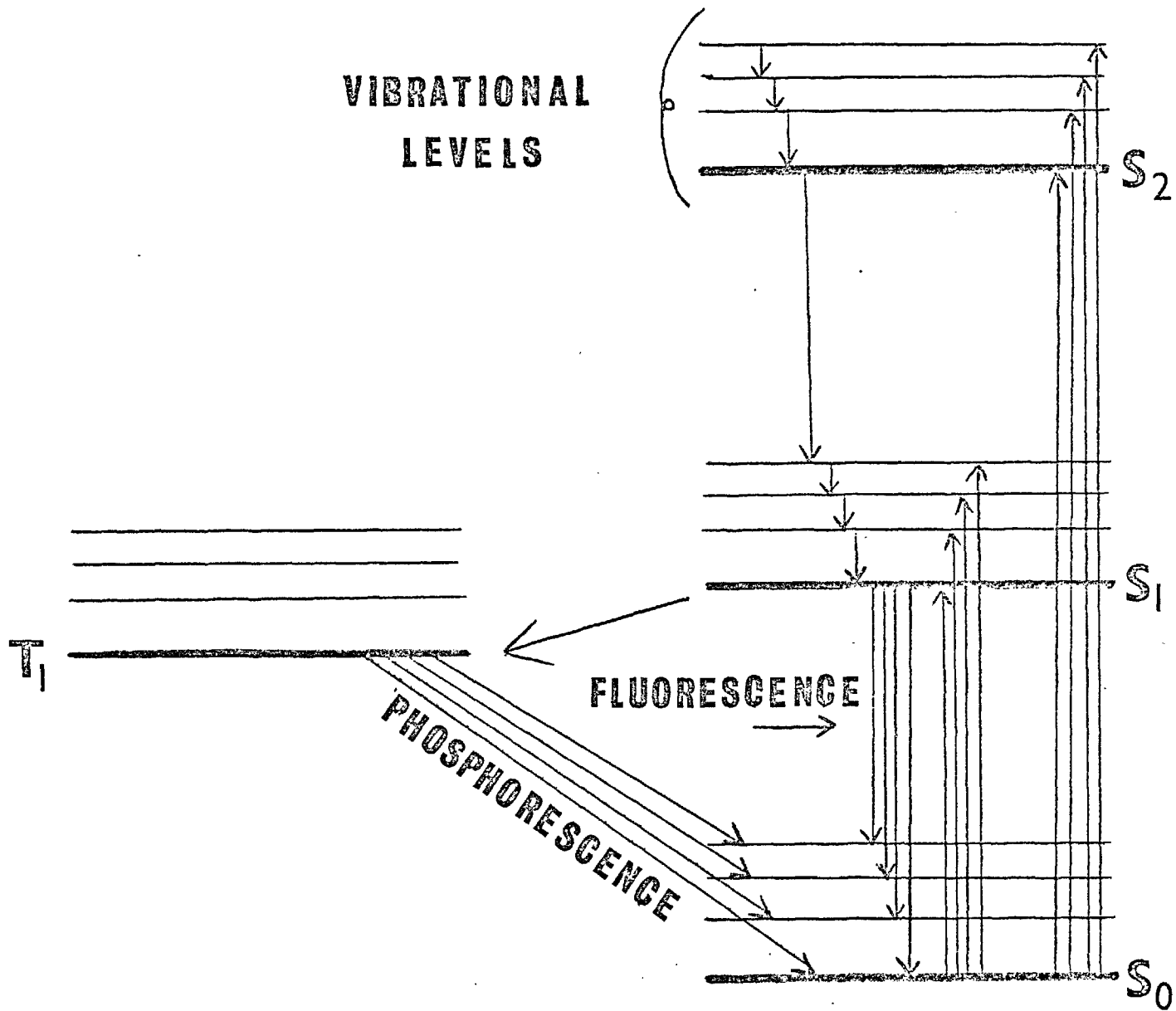

FIGURE 2

Others lose their energy in many ways, eg, by conversion to the triplet state ($S_1 \longrightarrow T_1$), by intermolecular collisions, or by photochemical degradation. If all molecules originally excited return to the ground state by emitting fluorescence, then one quantum of light is emitted for each quantum absorbed and the fluorescence efficiency is unity. If the other processes compete successfully with fluorescence, the fluorescence efficiency will be less than unity and may almost be zero.

Starting from S_1 then, two processes are possible, the radiant transfer to the ground state which has been discussed (fluorescence) and inter-system crossing to the lowest triplet state T_1 . The transfer of radiation from the lowest triplet state to the ground state ($T_1 \longrightarrow S_0$) takes place with a relatively long decay period and is observed as phosphorescence. The decay period of this radiation, its lifetime, depends very much on the type of compound, its environment, and especially the extent to which internal or external influences induce spin-orbit coupling. The lifetime can vary over a wide range from ca. 10^{-4} seconds to several seconds. Because of bi- and monomolecular quenching processes phosphorescence in solution at room temperature is rarely observed although it has been reported⁸. Phosphorescence in solution is much more readily observable at low temperatures in a rigid glass. Quenching effects are greatly reduced because of the low temperature and the dispersal of the solute in the rigid glass⁹.

To discriminate between the phosphorescence and the short lived fluorescence it is necessary to use an arrangement in which the beam of exciting light is interrupted periodically so that the sample can be viewed by the detector only during the periods of 'darkness', i.e. after the short lived fluorescence has completely decayed but while the long lived phosphorescence is still being emitted. For this purpose rotating sectors are placed in the beams of exciting light and luminescence. When the sectors are run with their slots in phase, both fluorescence and phosphorescence are observed. When the sectors are run with their slots out of phase, only the phosphorescence is observed.

As fluorescence emission almost always takes place from level S_1 (no matter to what level the molecule was originally excited) the fluorescence emission spectrum for any particular substance will be independent (within limits) of the wavelength, i.e. although the emission intensity will depend upon the wavelength of excitation, the shape of the emission spectrum will be the same. The same will of course be true for the phosphorescence emission spectrum although phosphorescence emission is always of longer wavelength (less energy) than fluorescence emission from the same substance since the first triplet state is always situated below the first excited singlet state. If the fluorescence (or phosphorescence) emission spectrum of a solution is found to vary with wavelength of excitation, the presence of a mixture of fluorescent (or phosphorescent) substances can generally be inferred.

1.5 Annihilation Reactions

The simplest mechanism for ECL as suggested by Hercules⁶ and later other workers¹⁰⁻¹² may be represented as follows. The aromatic hydrocarbon is reduced to the anion radical during the cathodic cycle,



During the anodic cycle the cation radical is produced,



or



and the R^{+} diffusing away from the electrode surface encounters R^{-} diffusing towards the electrode and the following reaction occurs,

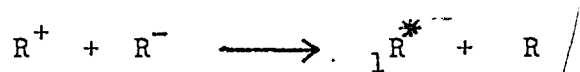

where ${}_1R^{*}$ denotes the excited singlet of the parent hydrocarbon. This excited singlet then undergoes radiative transition and returns to the ground state,

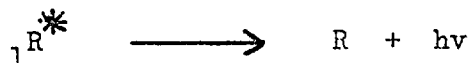

There are several difficulties however. First, R^{-} is generally recognised as being more stable in solution than R^{+} ¹³, yet from Hercules

experiments the anodically produced species was considered the most stable. It may be assumed from cyclic voltammetry and colour formation¹⁴ that the cathodically produced species is R^- and therefore this R^- may in many (but not necessarily all) cases be reacting with a product produced by oxidation of the solvent, supporting electrolyte, or electrode material so that the reaction,



is also possible. [Hercules tentatively postulated the formation of a complexed aromatic positive radical ion, such as R_2^+]. For example, cyclic potential step experiments showed that when 9,10-diphenylanthracene (DPA) anion radical was generated at an electrode and the potential of the electrode was switched to positive potentials resulting in the formation of bromine at a platinum electrode in TBAB, or mercury(II) at a mercury electrode in TBAP, the same emission was observed¹⁵. Similarly the reactions of DPA^- with lead tetraacetate, ceric ammonium sulphate, and nitrogen dioxide have been reported to result in chemiluminescence with an emission maximum corresponding to the normal fluorescence maximum of DPA, about 430 nm¹⁶.

In 1966, Chandross and Sonntag¹⁷ studied the reactions of the radical anions derived from various hydrocarbons and other fluorescent species with a variety of oxidising agents and reported chemiluminescence to be a common phenomenon in these systems.

The reactions of 9,10-DPA derivatives were, in particular, studied quite extensively and it was found that the spectrum of the emitted radiation was identical to the normal fluorescence spectrum of DPA.

The mechanism suggested was,

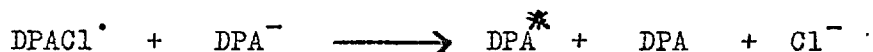
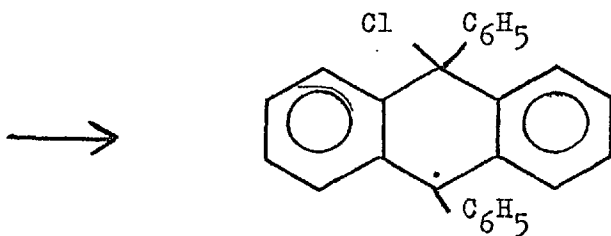
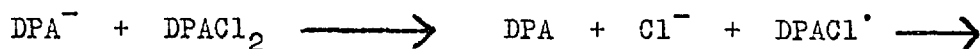

It was also suggested that DPACl^\bullet might ionise to DPA^+ and Cl^- and that the reaction might be a simple cation-anion reaction, i.e.

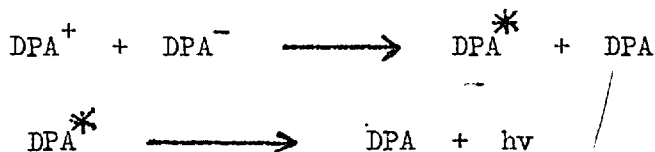

It was observed also that the reactions of several other reagents with DPA were chemiluminescent. These included benzoyl peroxide, p-toluene-sulphonyl chloride, p-toluene sulphonic acid anhydride, methane sulphonyl chloride, oxalyl chloride, and chlorine. A detailed study was made of the benzoyl peroxide (BPO) reaction. The sole nonacidic product of this reaction was DPA. The luminescence produced by this reaction was reported to be sufficiently intense to be easily visible upon

the addition of a drop of 0.01 M DPA⁻ solution, which contained about 10⁻⁷ mole of DPA⁻, to a dilute solution of benzoyl peroxide. The most probable mechanism was suggested to be,

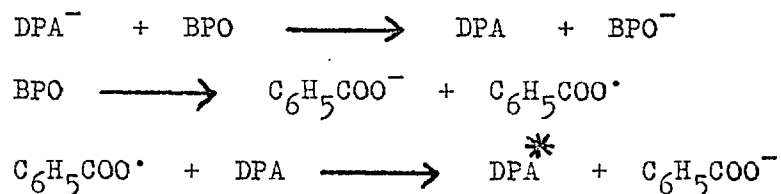

Bader and Kuwana¹⁸ have suggested that oxygen and its reduction products could be involved in ECL emission. Impurities could also account for ECL in some cases^{19,20}. Faulkner and Bard³⁴ have noted spectra differences depending on the method of purification of the solvent used during observation of the ECL of anthracene in DMF, this may reflect on the purity of the original DMF however²¹.

Two other important difficulties arise from consideration of the simple cation-anion annihilation reaction, however, and these are discussed in the next two sections.

1.6 Emission Spectroscopy

Although Hercules⁶ and later other workers^{10,11,22} had reported similar ECL and fluorescence spectra for a wide variety of compounds, it was found that a substantial number of cases existed in which the ECL and fluorescence spectra differed markedly. In almost all of these cases the ECL emission spectra have been at longer wavelengths than the

corresponding fluorescence spectra.

Chandross, Longworth, and Visco²³ reported ECL emission at longer wavelengths for a variety of compounds and ascribed this to "excimer" emission. The excimer effect in solutions was first observed by Forster and Kasper²⁴ who noted that dilute solutions of pyrene showed fluorescence in the ultraviolet but more concentrated solutions (above 10^{-4} M) showed a new broad structureless emission at longer wavelengths. The same effect was later noted for several pyrene derivatives²⁵.

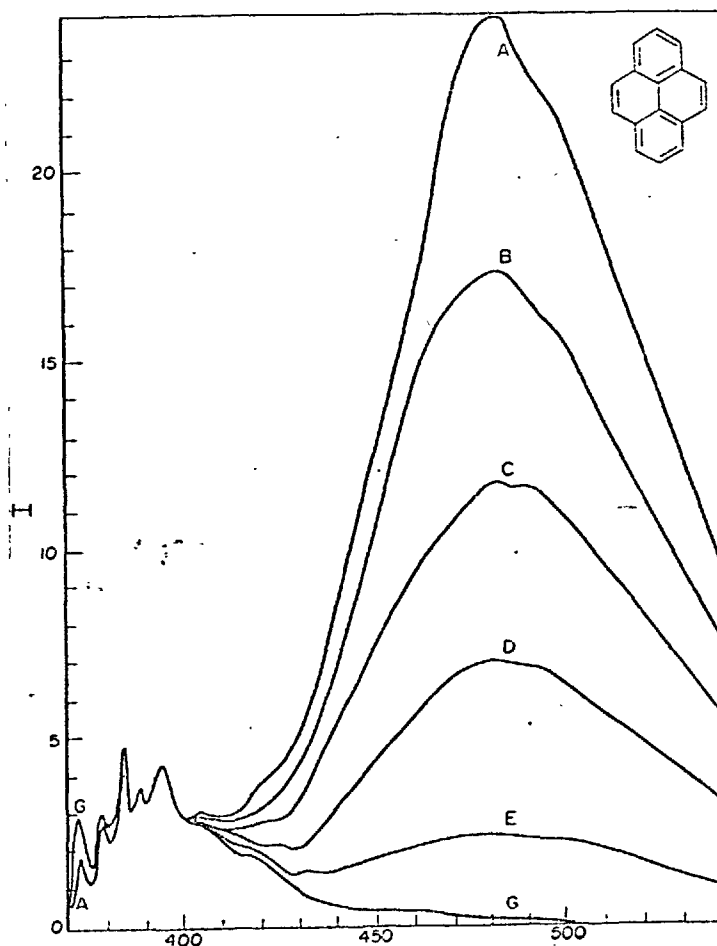
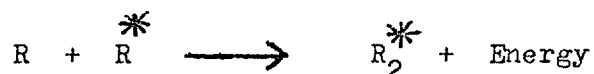
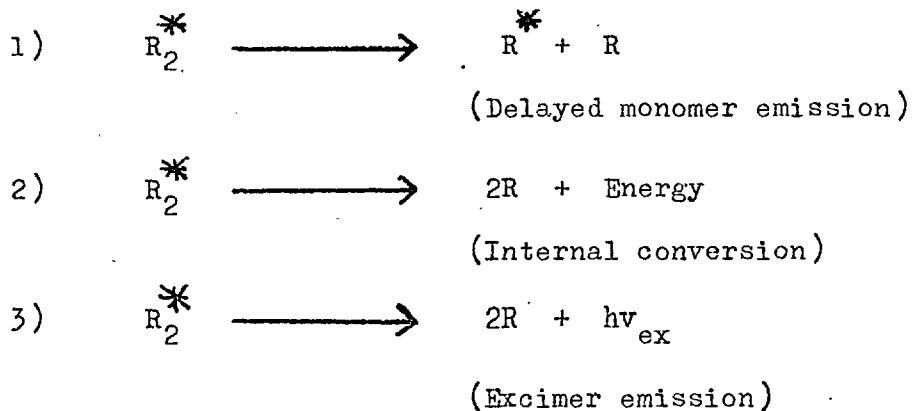

FIGURE 3. Fluorescence of pyrene in cyclohexane. A = 10^{-2} M; B = 7.75×10^{-3} M; C = 5.5×10^{-3} M; D = 3.25×10^{-3} M; E = 10^{-3} M; G = 10^{-4} M. From Reference 25.

There was found to be no change in the shape of the absorption spectrum of these compounds, even in the most concentrated solutions. It was therefore established that the change in fluorescence spectrum was not due to the association of pyrene molecules before excitation. The intensity of the longer wavelength fluorescence was proportional to the square of the pyrene concentration. Forster and Kasper interpreted these results by postulating that the species responsible for the broad structureless fluorescence was a dimer, formed by the combination of an electronically excited state pyrene molecule with a pyrene molecule in the ground state. The term "excimer" was later suggested by Stevens and Hutton²⁶. The mechanism may be represented as follows:



where R_2^* represents the excimer. [R_2 would represent the normal dimer]. The energy release is due to the lower energy level of the first excited state of the excimer compared to that of the monomer. The excimer can return to the ground state by at least three pathways. Others are possible with usually a much lower probability.



The fluorescence emission for an excimer can be distinguished from that of a monomer as there will be a longer wavelength component (it will always be a longer wavelength component due to the lower energy of the excimer) with increasing concentration.

Chandross, Longworth, and Visco²³ found the ECL emission spectra for anthracene, 9,10-dimethylantracene, phenanthrene, perylene, and benz (a) pyrene at longer wavelengths than the corresponding fluorescence spectra and for the reasons noted above ascribed it to excimer formation. Of the unsubstituted hydrocarbons studied, only naphthacene failed to show long wavelength emission by either ECL or fluorescence and this was attributed to "self-quenching". For the series, anthracene, 9,10-dimethylantracene, 9,10-DPA anthracene showed mainly excimer emission, 9,10-dimethylantracene showed a mixture of monomer and excimer emission, and DPA gave only monomer emission. The authors attributed this progression to varying amounts of steric hinderance by the compounds. Phenanthrene was reported to yield both monomer and excimer emission, while benzo (a) pyrene gave only excimer emission. The ECL spectrum for perylene was very similar to the reported crystalline excimer fluorescence recorded by Stevens²⁷.

A more detailed study of the ECL behaviour of 9,10-dimethylantracene was later made by Parker and Short²⁸. The results indicated that two groups of processes contributed to the ECL for this compound, one group leading to the direct formation of the excimer, the other group leading to direct monomer formation.

It has also been considered that in certain cases ECL emission is due to triplet decay, $T_1 \longrightarrow S_0$, i.e. a phosphorescence type mechanism is involved. Zweig et al²⁹ have reported this for phenanthrene. The authors found a broad and structureless ECL emission with a maximum of about 490-500 nm, corresponding very closely to the room temperature phosphorescence of this compound as reported by Parker and Hatchard⁸. Certain triplet quenchers (1,3,5- transhexatriene and 2,3- dimethyl- butadiene) quenched this ECL although they did not have any effect on the ECL emission of 1,3,4,7- tetraphenylisobenzofuran (TPIBF) where the ECL and fluorescence spectra were essentially the same. It was also reported that TPIBF did not show any low temperature phosphorescence even under very sensitive conditions³⁰.

At this point in time, (1967-68) a considerable controversy raged in the literature. Although Zweig and his colleagues defended their assignment of ECL emission to a $T_1 \longrightarrow S_0$ mechanism (at least for certain cases)³¹, this was disputed in a short communication in the same issue of the same journal (J. Phys. Chem.) by Chāndross and Visco³² who considered the direct electrogeneration of triplets very unlikely on thermodynamic grounds. Later Parker and Short³³ made more extensive measurements of the room temperature phosphorescence of phenanthrene (in ethanol) and found, in contrast to the earlier report⁸ that it was indeed structured. [The earlier work failed to reveal the structure because the phosphorescence was very weak and very broad monochromator bandpass was employed]. This structure was not found in the ECL emission spectrum of phenanthrene.

A third possibility has been considered to explain the occurrence of ECL emission at longer wavelengths than the corresponding fluorescence. This entails the formation of new species by the electrolysis of the original solutions. Using a simple step down transformer, Faulkner and Bard³⁴ made a study of the ECL of anthracene and found the spectrum to vary depending upon the applied voltage. At potentials above 5 V a new component was found to appear with an ECL maximum of about 565 nm. Above 6 V it was found that the ECL emission from anthracene itself (420 nm) decreased drastically while the intensity of the 565 nm band became steadily greater. Fluorescence spectra were obtained for both pre- and post- ECL solutions and it was found that new fluorescence bands appeared in the post- ECL solutions. The new fluorescence bands were not due to anthracene because anthracene fluorescence was not excited by the 420 nm radiation used to excite the species. The authors considered that the longer wavelength component was caused by emission from anthranol produced by decomposition of the cation radical of anthracene and probably excited by energy transfer from excited anthracene. It was considered that the anthranol existed in equilibrium with its tautomer anthrone.

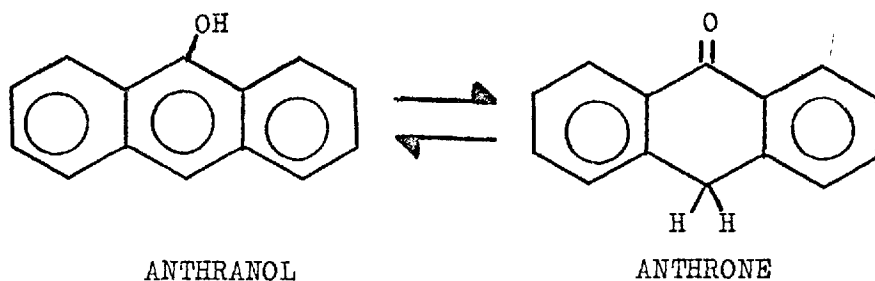

1.7 Pre-Annihilation Electrochemiluminescence

It has been reported^{35,36} that with certain aromatic hydrocarbons light can be detected while the anion is oxidised or the cation is reduced at potentials insufficiently positive, or negative, respectively to generate the oppositely charged radical ion and at potentials where there is no background electrolysis. This behaviour is termed "pre-annihilation electrochemiluminescence" or sometimes "energy deficient electrochemiluminescence" and is much less intense than the corresponding radical cation - radical anion ECL. For the case of rubrene³⁵, light was seen while oxidising the anion from about 0.2 V and reducing the cation from about 0.95 V. In both cases, these threshold potentials are sufficiently far removed from the potentials at which the oppositely charged ion is produced to rule out a simple annihilation reaction as a source of light. It was also observed that light could be produced while oxidising the anion and reducing the cation at overvoltages well below the energy corresponding to that of the rubrene singlet transition (2.3 eV). This requires a mechanism more involved than direct excitation to the singlet even though the emitted light corresponds to the transition $S_1 \longrightarrow S_0$. One possibility is that this pre-annihilation emission process initially generates triplets which then undergo a triplet-triplet annihilation reaction, producing singlets.

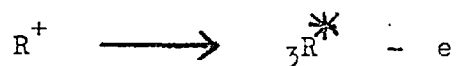
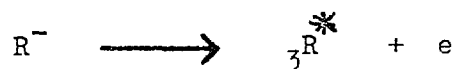

Followed by,

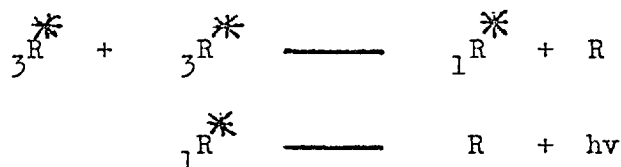

This has, however, been held improbable on theoretical grounds³⁷.

A second explanation involves oxidation or reduction of impurities in the system followed by homogeneous chemiluminescent electron transfer reactions. This simple impurity explanation is not reasonable, however, in view of the different threshold voltages observed for pre-annihilation ECL for various compounds³⁶. However it is possible that some common impurity (eg, H₂O) reacts with R⁻ and R⁺ to form new species (eg, RH⁻) which oxidise or reduce at potentials which do vary for different fluorescers but are generally less positive or negative, respectively, than the potentials required to oxidise and reduce the original fluor-escer. The apparent luminescent oxidation of the anion at potentials below that required for cation formation could then be attributed to oxidation of an anion decomposition product to an oxidised species (eg, RH⁺) which in turn would undergo a luminescent electron transfer reaction with an unreacted anion. An analogous reaction could be visualised for the cation. Peover³⁸, however, measured the potential of the species RH⁻,

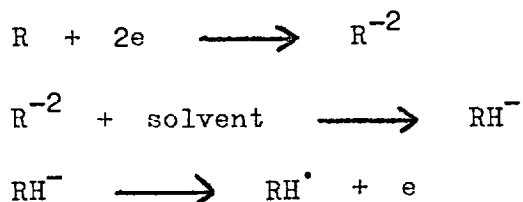

and found the oxidation potential too negative (≈ -1.0 V vs. SCE) to account for the pre-annihilation ECL. Explanations involving triplets have also been questioned by Visco and Chandross³⁹.

1.8 Mechanistic Considerations

A mathematical treatment of all the possible reactions occurring during ECL has been made by Feldberg^{40,41}. The light produced in the double potential step was related to the current, time, and kinetic parameters. Possible formation of excimers and triplet states was also taken into account. The processes considered by Feldberg are shown in the following reactions.

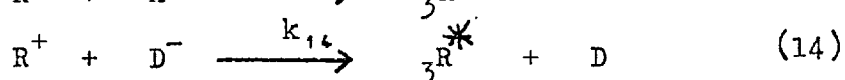
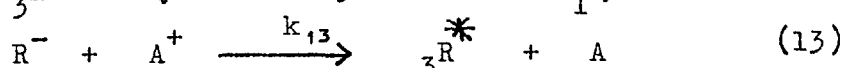
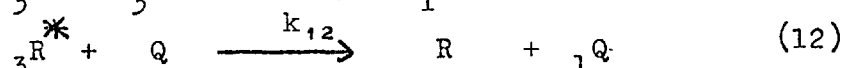
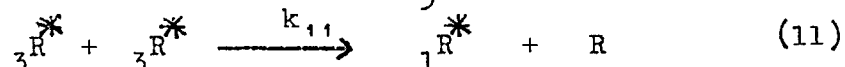
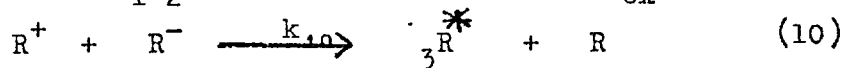
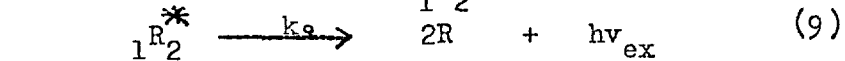
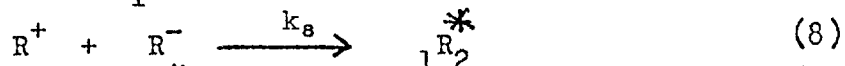
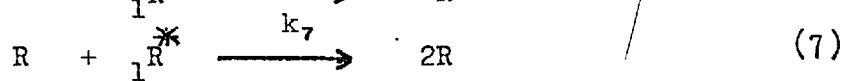
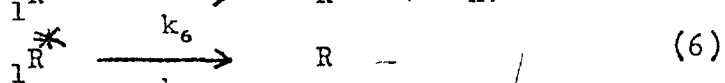
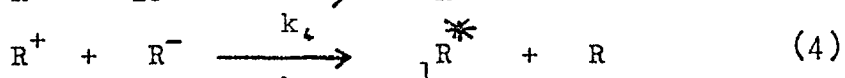
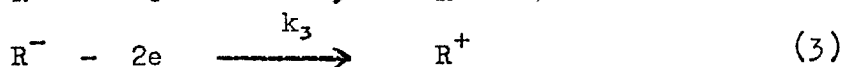
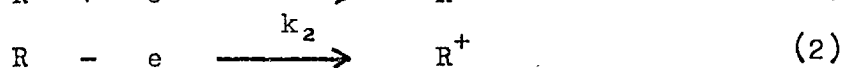
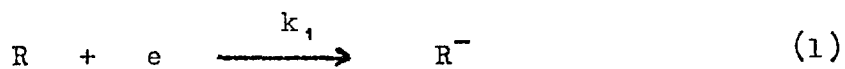

where Q refers to a quenching agent, D^- is an electron donor, and A^+ is an electron acceptor. The assumptions involved were that the decay of the excited state ($k_{1,1}$) is very rapid, that mass transport is diffusion controlled, and that quenching of excited species by nonexcited species ($k_{1,2}$) is negligible. As can be seen, the treatment included consideration of excimer (Reactions 8 and 9) formation and triplet states (Reactions 10-14). The method treated the solution as an array of small homogeneous volume elements parallel to the electrode surface, diffusion was regarded as the transfer of one volume element to another. Kinetic calculations were then made for each homogeneous volume element, the numerical solutions being accomplished by a computer. Under these circumstances the photons generated per unit time would depend upon the bulk concentration of the fluorescer R, the diffusion coefficients of R, R^- , and R^+ , the bimolecular rate constant for the $R^+ + R^-$ reaction, and the fraction of excited species that emit, i.e. the ratio of reaction 5 to reaction 6. The electrode area and the duration of the potential pulse would also be significant. The computer results of Feldberg showed that with certain limiting values of t_r and t_f the following expression should hold for diffusion controlled ECL.

$$\log \frac{f PF}{\pi^{1/2} \phi_e i_f} = -1.45 (t_r/t_f)^{1/2} + 0.75$$

where P is the photomultiplier output, f is a factor which converts the photomultiplier output to absolute light intensity in einsteins per second, F is the Faraday, i_f is the cell current at the end of time

t_f of generation of the first radical ion, t_r is the generation of the second radical ion, and ϕ_e is the ECL quantum efficiency.

A useful consequence of this expression is that the emission intensity should vary predictably with the times t_f and t_r spent generating the ion radicals. A test of this behaviour was made with rubrene in AN and DMF⁴² and the results seemed to be in good agreement although some problems remained with regard to the ion radical stability. A further investigation was conducted in benzonitrile⁴³ where both of the rubrene mono-ion radicals were essentially stable over the time periods employed.

1.9 Electrode Systems

Most electrochemiluminescent studies have been made with platinum electrodes although emission has also been reported from gold⁷, mercury¹⁵, and transparent tin oxide electrodes¹⁸. The usual electrode arrangement has been two platinum spirals relatively close to each other. In conventional ECL studies, both cation and anion radicals are alternatively generated at a single electrode, usually using unmodulated line current via a simple step-down transformer from the mains. Applied potentials have generally been 3-10 V. In some instances use of square waves at lower potentials has also been reported.^{12,29,30} High applied potentials are generally avoided because they would cause destruction of the solvent-supporting electrolyte system. Emission has been reported at very high potentials (ca. 100 V) however¹¹. Tests with a third electrode present in an ECL system containing $2 \cdot 10^{-3}$ M rubrene in DMF, with 0.1 M TBAP as supporting electrolyte showed that the half cell potentials

achieved at the working electrode were those of the desired first oxidation or reduction processes in the solution, even though the applied potential was much higher. It was assumed that the remainder of the potential was consumed by the IR drop due to the high resistances of the aprotic solvents considered.¹²

Several detailed studies of electrochemiluminescence under controlled potential conditions have been carried out^{19,35,36,43}. These have been double potential step experiments where one of the radical ions was first generated at a potential slightly more negative (or positive, for cation generation) than its half wave potential for a short time period, and then the potential of the electrode was switched to some positive (or negative) value for the second step. Emission was not usually observed during the first step, but was seen at the onset of the second step when the potential was sufficient. Double potential step experiments have provided useful information on the processes involved in ECL. They have shown that emission does not generally occur on potential reversal when the initially generated ion (usually the anion) is not sufficiently stable to be detected by cyclic voltammetry. A particular example of this was given for the two isomer forms of TPIBF.²²

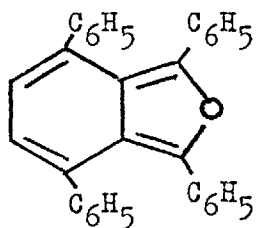

1,3,4,7 - TPIBF

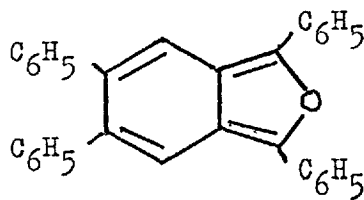

1,3,5,6 - TPIBF

The 1,3,4,7 - tetra substituted isomer was found to exhibit intense ECL emission, while the 1,3,5,6 - isomer gave barely detectable emission, this despite the fact that the fluorescence efficiency of the latter was greater than that of the former. The stabilities of the anion radicals were much the same, both having lifetimes over twenty seconds in DMF, but the cation radical lifetimes were very different. The 1,3,4,7 compound had a cation radical lifetime of about one second but the 1,3,5,6 compound had a lifetime of less than 0.01 second.

The use of a rotating ring-disk electrode system has also been reported⁴⁴. In this system a dual channel potentiostat was used and the appropriate oxidation and reduction potentials applied to the disk and ring. The ring-disk electrode assembly consisted of a platinum ring and disk separated by a 0.02 mm Teflon insulator and independently connected to stationary leads through loop brushes. The Luggin compartment extended into the interior compartment and was fitted with an aqueous SCE, and a side arm for the attachment of the sealed cell to a vacuum-helium line for the purposes of solution deaeration. The entire assembly extended into the central cell compartment where it was rotated at a preset rate. ECL was observed at the ring. The apparatus was used in the study of a variety of compounds. Of particular interest was the ECL of a mixture of pyrene and N,N,N',N' - tetramethyl-p-phenylenediamine (TMPD) in DMF with TBAP supporting electrolyte. It was suggested that the TMPD was oxidised to its cationic form (sometimes referred to as Wurster's Blue) and that this species served as a stable oxidant for the pyrene anion. The observation was in general agreement with that of Weller and Zachariasse⁴⁵, who observed pyrene chemiluminescence in solutions

of the pyrene anion in contact with solid Wurster's Blue perchlorate. The observed ECL spectra showed both excited monomer (418 nm) and excimer (468 nm) bands. The ECL process was affected by other chemical reactions in the solution, however, and somewhat different results were obtained depending on whether the pyrene anion was generated at the disk or at the ring. The ring-disk electrode system was also suggested for organic syntheses, involving the interaction of two unstable species to form a new compound.

1.10 Magnetic Field Effects

Faulkner and Bard⁴⁶ have studied the magnetic field dependence on the ECL intensity for the reactions of the cation radical of TMPD with the anion radicals of anthracene and DPA. These reactions are energy deficient and it was considered that triplet states might be involved in these mechanisms. The reactants for the magnetic field experiments were about 10 mM and the solvent used for the studies was DMF. The usual system for recording light output was used except that the photomultiplier tube was removed 90 cm from the magnet to ensure that the detection system would be unaffected by the field. The detection system was tested for magnetic field dependence by positioning its components in their operating configuration and allowing a small amount of room light to enter the photomultiplier tube. The system was completely unaffected by the applied field, even at the highest photomultiplier sensitivity.

The experimental results obtained by Faulkner and Bard are shown in Figure 4. For solutions containing TMPD (Wurster's Blue - WB) the

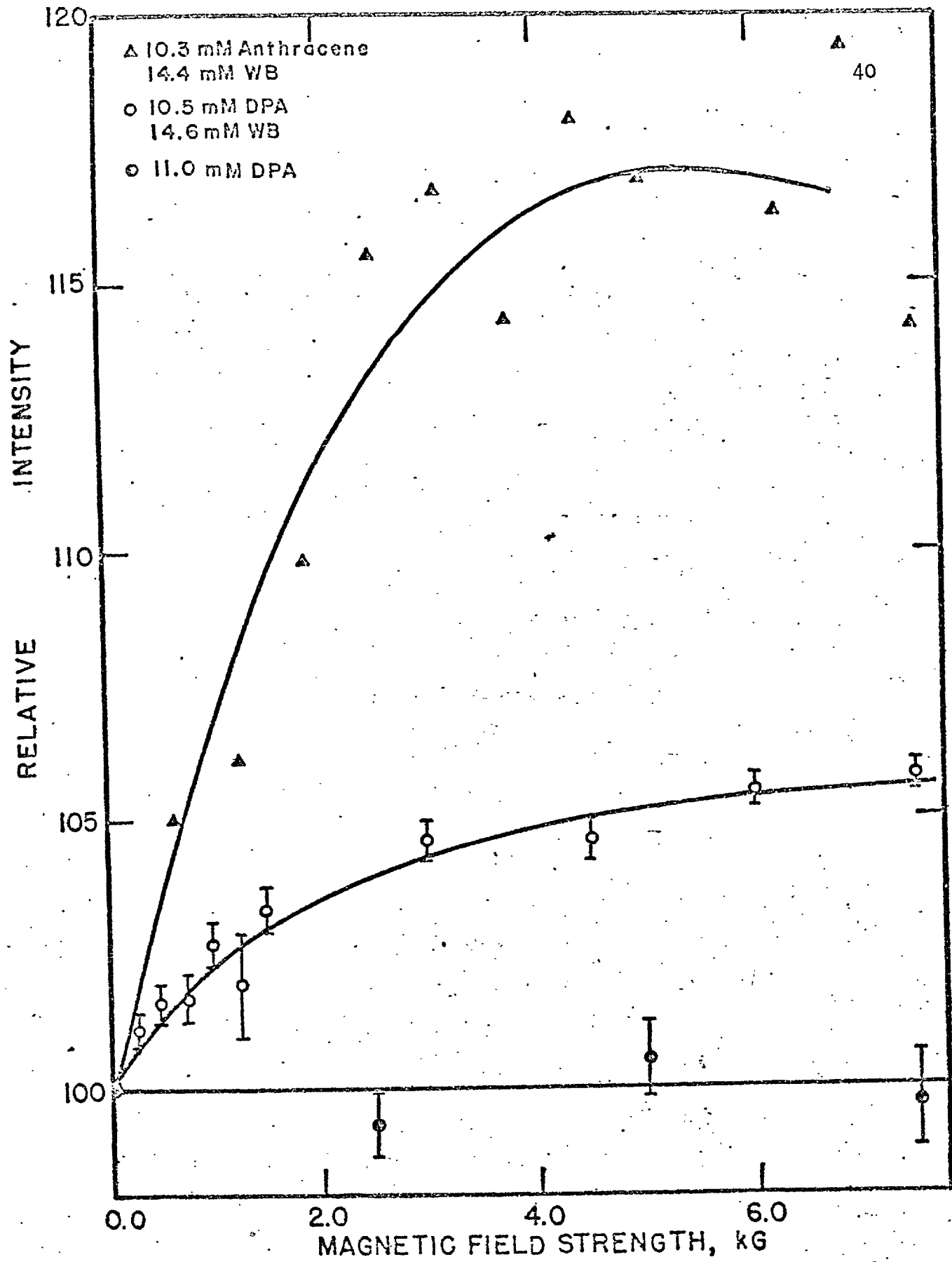

FIGURE 4

From Reference 46

emission intensity was found to increase with the applied field. This contrasted markedly with that of the solution containing only DPA where the field had no effect on the emission intensity. From these results the following conclusions were drawn. First, paramagnetic species are involved in at least one rate controlling step for light emission in the energy deficient case, and the rate of that step is field dependent. Secondly, either no paramagnetic species are involved in the rate controlling steps for the light producing process for the case of DPA alone, or paramagnetic species are involved but their behaviour is unaffected by the field.

To rationalise the energy deficient reactions, the authors postulated that the hydrocarbon triplet was formed in the radical annihilation step. This would be followed by triplet-triplet annihilation, creating a hydrocarbon molecule in its first excited state. Normal DPA ECL (the reaction involving annihilation of DPA^+ and DPA^-) is believed to result directly in a DPA molecule in its first excited singlet¹² and would therefore not be affected by the field. Since the radicals and triplets are paramagnetic, the electron transfer steps and the triplet-triplet annihilation would be influenced by the field.

1.11 ECL Carcinogenic Studies

Many aromatic hydrocarbons are carcinogenic, i.e. when applied to tissues they produce tumours. It is a well known fact that many thousand individual compounds are produced in the burning of cigarette smoke and a great many of these are aromatic hydrocarbons⁴⁷. The polynuclear

hydrocarbons have a number of characteristic features which distinguish them from the majority of carcinogenic compounds in that they act at the point of induction, and that their effective doses are very small, in the order of micrograms, and that they produce tumours in almost all types of animals. Bobr and his co-workers in the USSR have suggested ECL as a technique to trace aromatic hydrocarbons in liver lipids,⁴⁸ so as to correlate the movement with carcinogenic activity. Mice were used in their study. First, the mice were injected with 1 mg of a polynuclear hydrocarbon dissolved in 0.2 ml of olive oil. Then, after a period of time, the animals were decapitated, the livers removed, weighed, and homogenised. After the proper treatment of the lipid to obtain a solid residue, the residue was dissolved in TEAB-DMF. [The concentration of the supporting electrolyte was not stated but would not be critical as long as it was much greater than that of the hydrocarbon]. The ECL intensity was measured as a function of the number of days after injection that the liver had been removed from the animal. It was found that the ECL emission rose gradually for about 20 days, this rise was roughly linear. The length of time for the hydrocarbons to accumulate in the liver lipid was found to be independent of the carcinogenic activity of the hydrocarbon.

1.12 Hydrocarbon Nomenclature

Three different systems of nomenclature have been used in the literature to describe polynuclear aromatic hydrocarbons and related substances.

These are,

- 1) Traditional numbering of the basic hydrocarbon skeleton as employed by Clar⁴⁹,
- 2) A new system of numbering proposed in 1955 in accordance with the directions of the International Union of Pure and Applied Chemistry^{50,51} (IUPAC),
- 3) Identification by letter, also proposed by IUPAC.

The use of all three possible methods of identification side by side has caused considerable confusion in the literature. Unfortunately, many papers do not indicate structural formulas and it is not always possible to identify hydrocarbons from papers by different authors. Consider the compound,

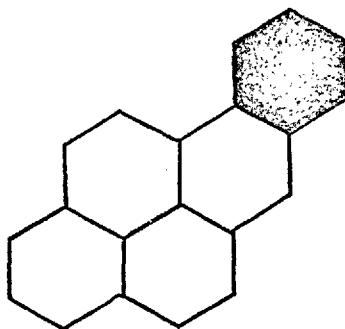

which is traditionally referred to in the literature as 3,4- benzopyrene (substituent shaded in) but which would be described as 1,2- benzopyrene according to IUPAC rules or as benzo (a) pyrene by letter identification. The "o" may

sometimes be dropped, i.e. benzpyrene instead of benzopyrene.

The compound,

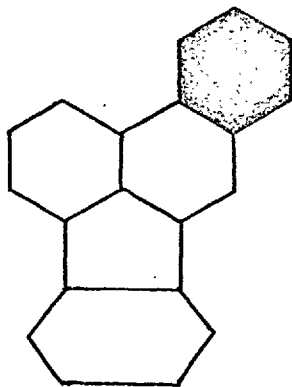

may be called 3,4- benzo fluoranthene (System 1); 2,3- benzofluoranthene (System 2); or benzo (b) fluoranthene (System 3). Trivial names are also used. 5,6,11, 12- naphthacene is commonly called rubrene. Naphthacene itself is sometimes referred to as tetracene.

9,10- benzophenanthrene may be referred to as triphenylene.

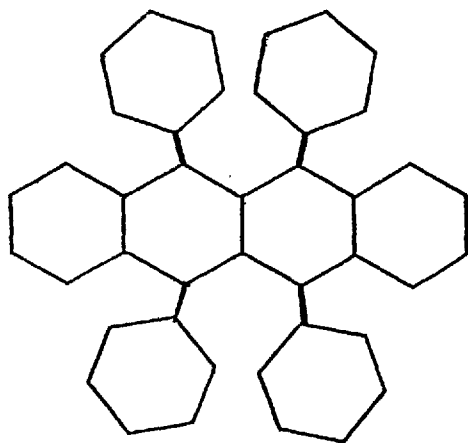

RUBRENE

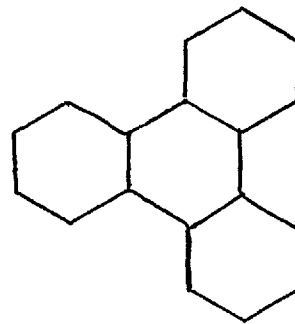

TRIPHENYLENE

It is the opinion of the author of this thesis that identification of substituted benzo compounds by means of letters is the most definitive and this is the method generally used in this thesis. Structural formulas are also clearly indicated for all of the compounds studied which were found to show ECL. Double bonds in the benzene ring are not shown except where their omission could cause confusion.

1.13 Summary and Objectives

It will now be appreciated that a considerable amount of information concerning ECL (especially in aprotic media) has become available during the last few years. Overall consideration of the investigations done on the phenomenon, however, shows that although several groups of workers have studied ECL almost independently, most found themselves working along roughly the same lines. Therefore, to a certain extent, duplication of results has taken place. In particular, the French group^{19,52,53} seemed to be unaware of the major part of the work of the other groups.

The purpose of the research work outlined in this thesis was,

- 1) To examine a large number of compounds for ECL,
- 2) To construct reliable equipment for the quantitative examination of ECL allowing as much experimental control over the parameters (sweep rate, wave form, potential, etc) as possible,

- 3) To study the mechanism(s) involved for a selected number of compounds, to study the cyclic voltammetry as applied to ECL (detection of ECL at reduction and oxidation peaks), to record spectra under varying conditions, and to contrast this with pre- and post- ECL fluorescence (and where applicable phosphorescence) spectra in order to characterise the processes involved,
- 4) To examine the possible application of ECL to analytical chemistry and to note ECL characteristics of selected mixtures with a view to being able to distinguish between specific components.

CHAPTER TWO

EXPERIMENTAL PROCEDURE

2.1 Preliminary Experiments

It was decided to construct a relatively simple device to allow the screening of a large number of compounds for possible ECL. A two electrode system was used with an applied voltage of 7.0 V, 50 Hz, provided by a simple step-down transformer.

The first electrode was a straight platinum wire (0.004 inch diameter) about 1.5 cm in length. The second electrode, also consisting of the same platinum wire, was wrapped as a spiral about the first in such a way that the distance between electrodes was about 2 mm. The bottom ends of the electrodes were separately sealed into a glass bead to provide support for the electrode system. The top ends were sealed into separate lengths of glass tubing (as shown in Figure 5) and from the top end electrical connection was made to the step-down transformer. Nitrogen inlet and outlet tubes were provided and the assembly sealed through a Teflon block with a top brass plate. The Teflon block provided the lid of the cell. The cell itself was fused quartz or glass precision cells (Thermal Syndicate Ltd., Wallsend, Northumberland) and was a standard spectrofluorimeter size, 10mm x 10mm x 40mm.

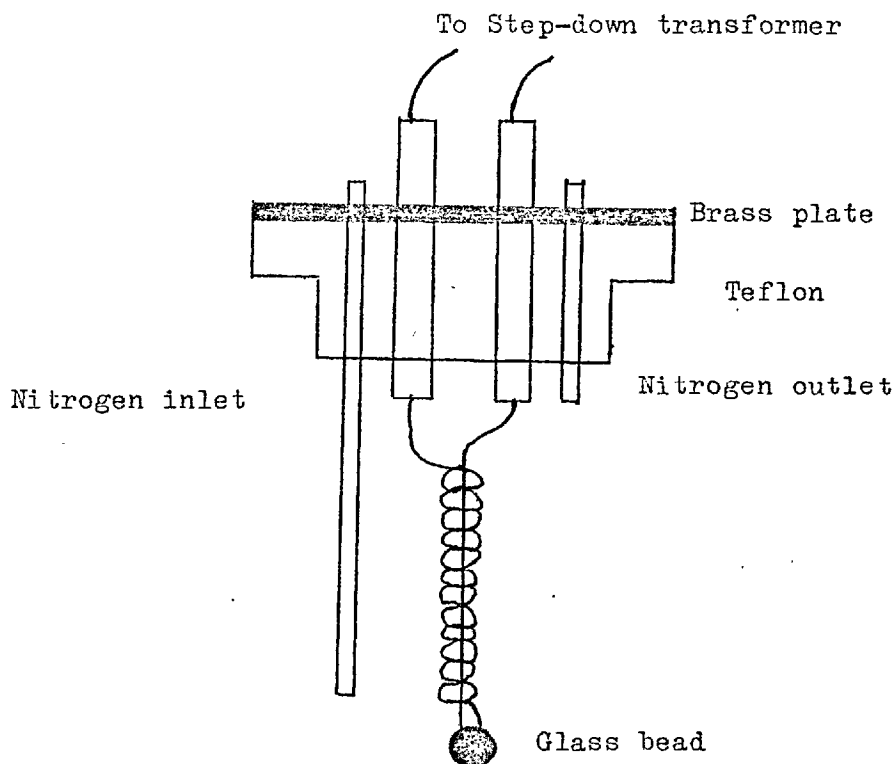

FIGURE 5. Electrode system for preliminary experiments

The cell was inserted into the cell cavity of an Aminco-Bowman spectrofluorimeter set up in such a way to allow any emitted light to pass directly to the photomultiplier tube, i.e. bypassing the emission monochromator of the instrument. Black cloth was wrapped around the top of the instrument to provide a complete light seal. As the monochromator of the instrument was bypassed, it was of course impossible to make any spectral measurements at this stage but the setup did allow much greater sensitivity for the emitted light. The light output was measured on an Aminco photomultiplier microphotometer.

Solutions of possible ECL emitters were made up as ca. 10^{-3} M solutions in DMF (BDH Laboratory Reagent grade) with 10^{-2} M TBAP as supporting

electrolyte. The compounds were obtained from a variety of sources. The TBAP was prepared by the neutralisation of tetra-n-butyl ammonium hydroxide (BDH General Purpose reagent) with 70% perchloric acid (AnalaR). The product was recrystallised twice from a 50-50 water-ethanol mixture and dried at 95°C for twenty four hours.

The compounds examined were divided into three categories:

- A) Compounds showing moderate to intense ECL
- B) Compounds showing only weak ECL
- C) Compounds not showing ECL

Compounds in Category A were noted and studied further with the more sophisticated apparatus later constructed, compounds in Category B were not studied further. Most of the compounds considered in this preliminary investigation fell into Category C. Many of the compounds in Category C (particularly those containing nitrogen or sulphur) also corroded the electrodes. This could be seen by blackening of the electrodes and also by the fact that strong ECL emitters such as DPA showed very weak ECL after corrosion by a previous substance.

<u>Test Compound</u>	<u>Intensity</u>
1) DPA	800
2) Phenazine	No ECL
3) DPA	20

A general electrode cleansing procedure was devised and used for all of the electrode systems later constructed. This consisted of immersing

the electrode system in the cell in an aqueous dilute solution (ca. 10^{-1} M) of perchloric acid and electrolysing for about one minute. The electrode system was then washed with distilled water, followed by washing with acetone, and finally drying with a hot air blower. Occasionally it was necessary to go through the electrolysing process twice although one minute usually sufficed. The "efficiency" of the electrode was checked with a strong ECL emitter such as DPA or rubrene. A selection of compounds in Category C is shown in Table 2.

TABLE 2

2- Amino-thiazol	Erioglaucine A
3- Amino-phthal-hydrazide	Fluorenone
8- Aminoquinoline	Malachite Green
Azobenzene	4- Dimethylaminoazobenzene
Azulene	Methoxy phenyl pyridine
Benzanthrone	2- Naphthol-3,6-disulphonic acid
Calcein	1- Naphthoic acid
M- Cellulose	1,10- Phenanthroline
1- Chloro anthraquinone	Phenazine
1,5- Dihydroxy naphthalene	Quinaldine
2,2'- Dihydroxy diphenyl	Rhodamine B
2,2'- Dipyridyl	Victoria Blue

Compounds in Category B are shown in Table 3.

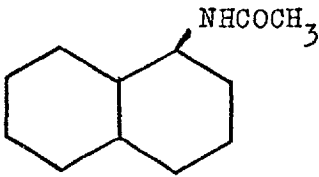
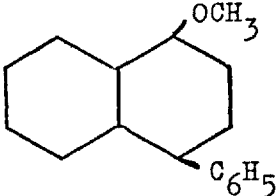
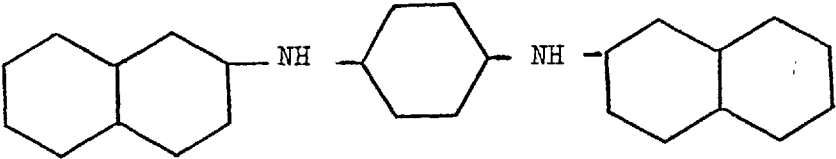
TABLE 3
<p data-bbox="467 420 904 458">Acetyl-α-naphthylamine</p> 
<p data-bbox="467 824 937 858">Methoxy benzoyl naphthalene¹</p> 
<p data-bbox="365 1220 1209 1258">N,N'-di-β-naphthyl-α-naphthylamine (Nonox CI)</p> 

¹ Isomer not stated but presumed to be as shown.

Some general observations may be made from the preliminary experiments. First, exclusion of oxygen is necessary for ECL as has been reported by Hercules⁶. Although emission could be observed in non-deoxygenated solutions for some very intense ECL emitters (in particular DPA and rubrene) deoxygenation increased the intensity several fold. After deoxygenation, it was relatively unimportant whether the solution was stirred or unstirred. [Under later controlled potential conditions this was found to be not so]. Deoxygenation generally took 3-5 minutes. Secondly, all compounds showing ECL were found to be fluorescent (visually under an ultra-violet lamp) but not vice-versa. A series of anti-oxidants were examined for ECL, most showed fluorescence but only Nonox CI showed ECL. Thirdly, polynuclear aromatic hydrocarbons were found to be strong ECL emitters as had been reported. Substituted compounds with functional groups such as SO₃, OH, NO₂, COOH, etc. were not ECL emitters however. Compounds containing N or S in their ring structure did not generally show ECL. Some exceptions were noted however. Carbazole, indole, and dibenzothiophene (diphenylene sulphide) were all found to show ECL.

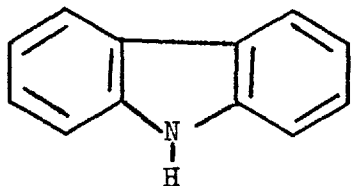

CARBAZOLE

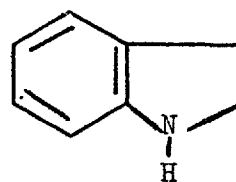

INDOLE

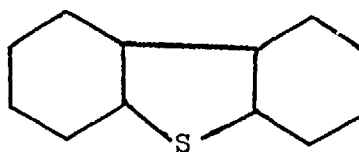

DIBENZOTHIOPHENE

The general observation was made that the presence of at least a naphthalene or diphenyl group is necessary for ECL. Even though ECL was observed for Nonox CI, however, no ECL emission could be seen for N,N'-diphenylbenzidine.

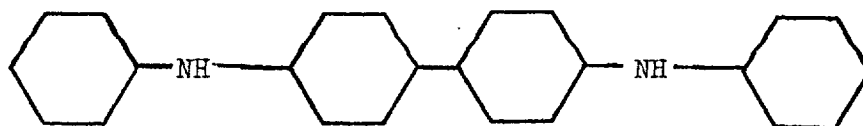

Emission was seen for compounds such as diphenyl and higher phenyls such as p-quinquephenyl however. Benzyl diphenyl also showed moderate ECL emission.

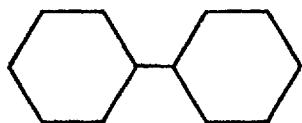

DIPHENYL

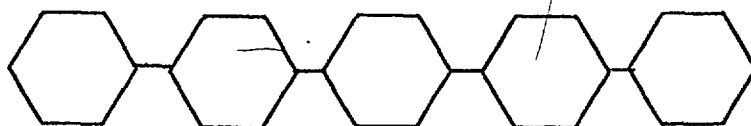

p- QUINQUEPHENYL

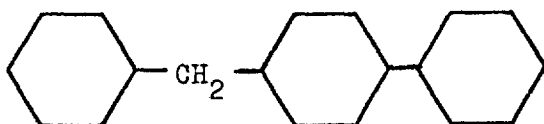

BENZYL DIPHENYL

1,8- diphenyl- 1,3,5,7- octatetraene (DPOT) was found to be a strong emitter, however, despite the fact that the two phenyl groups were at opposite ends of the molecule.

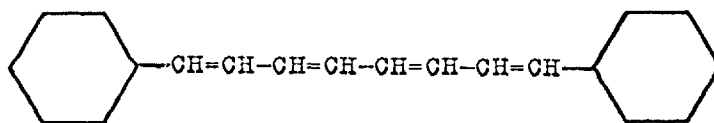

1,8- DIPHENYL- 1,3,5,7- OCTATETRAENE

The lack of ECL for azulene was surprising. Azulene is isomeric with naphthalene which does show ECL. Two reasons for this lack of ECL are possible,

- 1) Azulene is strongly fluorescent but this fluorescence is from $S_2 \longrightarrow S_0$.⁵⁴ [This (along with some azulene derivatives) is the only exception to the general rule that fluorescence occurs by $S_1 \longrightarrow S_0$]. It is possible that insufficient energy is applied to raise the molecule to its second excited singlet.
- 2) Azulene is intensely coloured blue, in DMF solution. (Most hydrocarbons considered were colourless). It is possible that weak ECL is obscured by this colour.

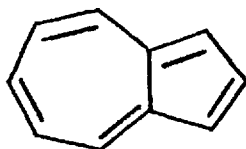

AZULENE

2.2 Apparatus

A general diagrammatic representation of the apparatus employed is shown in Figure 6. The signal generator used was a Hewlett-Packard Corporation Model 3300A, this has a two channel triangular, square, or sine wave output, a variable frequency control 0.01 Hz to 100,000 Hz response and single sweep and phase lock facilities provided by a Model 3302A Trigger/Phase Lock plug-in unit. The single cycle mode of operation allowed one cycle of any of the Model 3300A functions to be obtained. Free run operation (continuous scanning) was the mode usually employed however.

The potentiostat circuit was constructed using operational amplifiers. The term "operational amplifier" refers to a high quality d.c. amplifier able to perform mathematical operations such as multiplication, addition, integration, and differentiation. They were originally developed for analog computers and are now usually solid-state devices.⁵⁵ Many circuits have been adapted for use in chemical instrumentation^{56,57}. A triangular symbol is used to depict the amplifier, the two inputs are along the left vertical side, and the output is from the vertex opposite. The negative input is almost always shown on top. The inputs are designated as positive or negative in the following sense; a positive signal applied to the "positive" input (relative to the negative input) will cause a positive output voltage. The same positive signal applied

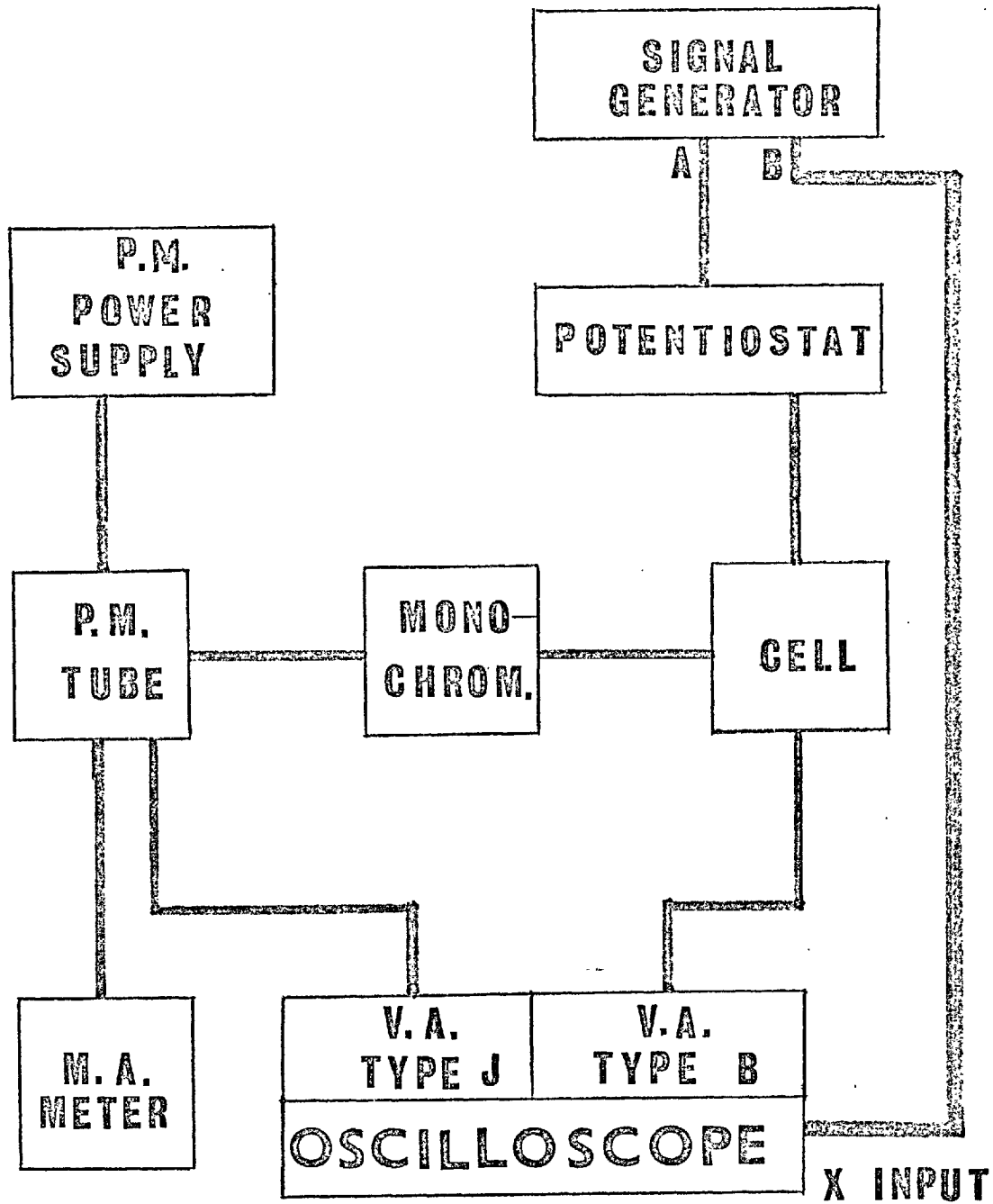

FIGURE 6

to the "negative" input (relative to the positive input) will cause a negative output voltage with respect to earth. The positive input is connected to earth in many applications so it is often the case that the operational amplifier becomes an inverting amplifier, giving negative output for positive input. Consider the following generalised circuit,

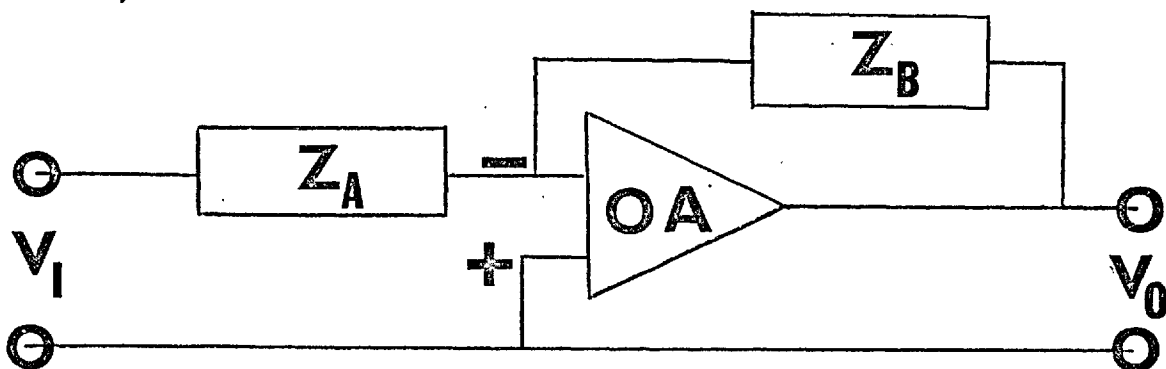

FIGURE 7

If Z_A and Z_B are resistors, the properly applied amplifier will yield an output voltage V_0 equal to the input signal V_1 multiplied by the factor Z_A/Z_B . If Z_A is a resistor and Z_B a capacitor, the circuit will integrate the input voltage in accordance with an externally established time constant. If Z_B is a transistor, the circuit will yield the logarithm of the input.

The potentiostat circuit constructed is shown in Figure 8. It is of a type described by Schwarz and Shain⁵⁷. The operational amplifiers were Model PF85AU (Philbrick Research, Boston, Mass.) A stabilised power supply is necessary for the running of these operational amplifiers. This was provided by a Coutant Model ED 50/15/15 (Coutant Electronics Ltd., Reading, Berkshire) modular stabilised voltage power supply set

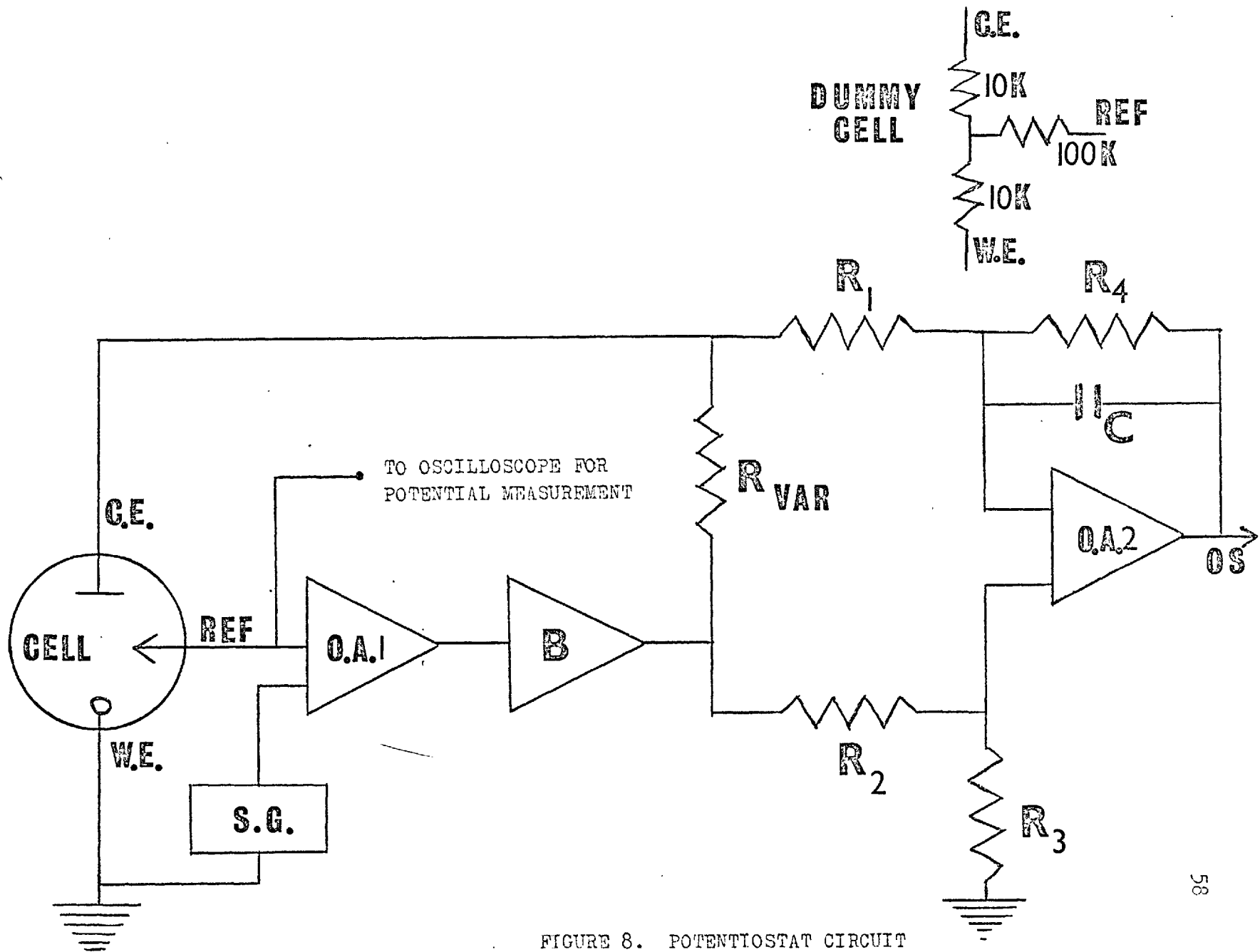

FIGURE 8. POTENTIOSTAT CIRCUIT

to exactly ± 15.0 V. A Hewlett-Packard Model 3439A Digital Voltmeter was used for the necessary voltage adjustments. The circuitry was assembled onto Veroboard. To prevent any A.C. pickup from the mains the power supply was shielded from the circuit by tinfoil. A neon light was placed across the mains to indicate power on. The assembly was built into a standard (10" x 6" x 12") instrument box (Lund Bros., Wandsworth, London, W.W.18).

The condition of both inputs existing at identically the same potential when there is zero output from an operational amplifier is very difficult to achieve by design. A correction factor for the Philbrick amplifiers is indicated on the side of each amplifier. It was necessary to apply a resistance between a terminal marked "trim" and the $+ 15.0$ V terminal. This correction factor is usually referred to as "offset trim".^{55,56} For O.A. No. 1 this was 22,000 ohms and for O.A. No. 2 it was 21,000 ohms.

The current output for a model PF85AU operational amplifier is limited to 2 mA. As the cell design (q.v.) required greater current outputs, a Philbrick P66A booster amplifier (marked B in the circuit diagram) was inserted into the circuit immediately after the first operational amplifier. This amplifier was further boosted by inserting resistors from terminals on the booster amplifier (marked "+ Boost" and "- Boost") to the $+ 15.0$ V and $- 15.0$ V terminals, this in accordance with the manufacturer's directions. Resistance value for + Boost ——— $+ 15.0$ V was 40 ohms and for - Boost ——— $- 15.0$ V the value was 32 ohms. Sprague ten watt resistors were used.

Resistors R_1 , R_2 , R_3 , and R_4 were all 100,000 ohms. The 500 pF ($\pm 1\%$) capacitor was inserted into the circuit to prevent oscillation. R_{VAR} allowed sensitivity control via a ten position Maka switch (Radiospares Ltd., London, W.1). Position No. 1 was a direct short, under these conditions (since R_1 and R_2 have the same value) no current can flow. This position was generally used when it was desirable to record spectra under square wave conditions at relatively high potentials. The ten positions are shown in Table 4.

TABLE 4	
<u>Position</u>	<u>Resistor Value (in ohms)</u>
1	Direct short
2	50
3	100
4	500
5	1,000
6	5,000
7	10,000
8	30,000
9	100,000
10	500,000

The values chosen were relatively arbitrary over the limits chosen. The 50 ohm resistor was a 5 watt wound wire resistor, all others (including $R_1 - R_4$) were 1 watt metal oxide resistors, $\pm 2\%$. All resistors and the capacitor were supplied by Radiospares.

Positions 4-7 were generally found most convenient under triangular wave (cyclic voltammetry) conditions. The overall performance of the circuit was checked using a dummy cell consisting of fixed resistors. A triangular wave was applied from Channel A of the signal generator through the circuit to allow any distortion to be readily observable on the oscilloscope taken from the point "OS" on Figure 8. The horizontal input to the oscilloscope was taken from Channel B of the signal generator and was always a triangular wave.

A 1 K helipot (Beckman Instruments Ltd., Fife) stepped down to 2.5 V (via resistors from the ± 15.0 V Coutant power supply) allowed control of the offset voltage of the signal generator. The signal from the helipot was fed into a rear connection of the signal generator marked "circuit ground". The offset voltage could be set from + 2.5 V to - 2.5 V by the helipot. By setting the offset voltage to, for example, + 1.0 V a ± 2.0 V swing would become - 1.0 V ——— + 3.0 V. The offset voltage was monitored by a voltmeter (Radiospares Type MR 31 MC) built into the instrument case or directly from the reference electrode to the oscilloscope for more exact potential level measurements. A double-pole - double-throw switch was used to set the voltmeter to positive or negative scale reading.

A linear metal dielectric interference filter (Barr and Stroud, Ltd., London, S.W. 1) was used as monochromator. The working range was 400 to 700 nm. The monochromator was built into a light tight brass

housing compartment set up against the photomultiplier housing. This may be seen in Figure 9. The monochromator was moved between the photomultiplier and the cell housing via a push-pull brass rod and the rod marked off at intervals corresponding to each 20 nm between 400 nm and 700 nm. The monochromator was calibrated against sodium, tungsten, and mercury lamps. The cell housing was constructed by soldering together the appropriate pieces of brass sheet and using Araldite to hold the assembly against the side of the monochromator housing. A 2 mm slit width made from thin aluminium was inserted into the cell housing on the near side to the monochromator housing. The entire assembly (photomultiplier housing, monochromator housing, and cell housing) was painted with Belco black paint to provide a light tight seal.

The sample cell was as described in the previous section, glass cells were usually used. A similar machined Teflon stopper was used and four electrodes and nitrogen inlet and outlet tubes (PTFE) sealed into this as shown in Figure 11. The working electrode generally used was a platinum spiral supported by a glass rod. Alternatively, a small point platinum electrode was used to record cyclic voltammetry data. It was considered that there might be some differences in the cyclic voltammograms between the relatively large spiral electrode and the point electrode but this was found not to be the case. The use of a mercury plated gold electrode was also investigated but presented no particular advantages for the recording of cyclic voltammetry data. Light intensity using this electrode was much less intense than from the corresponding platinum electrode of approximately the same area.

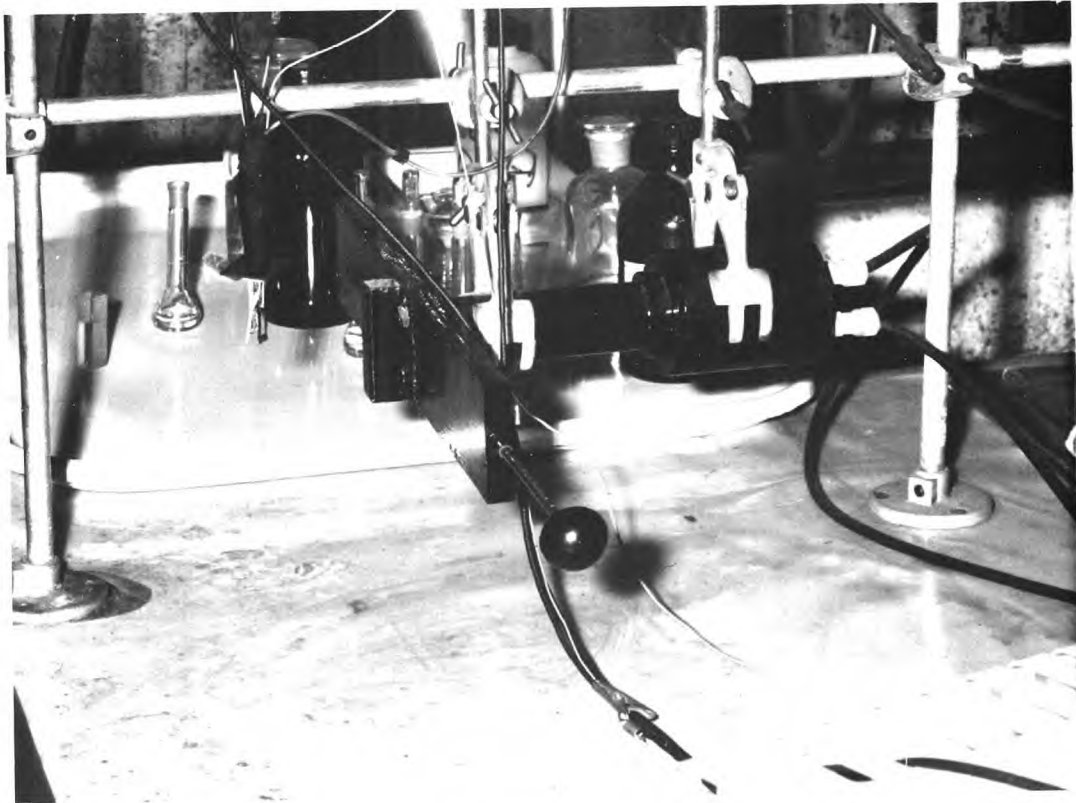

FIGURE 9

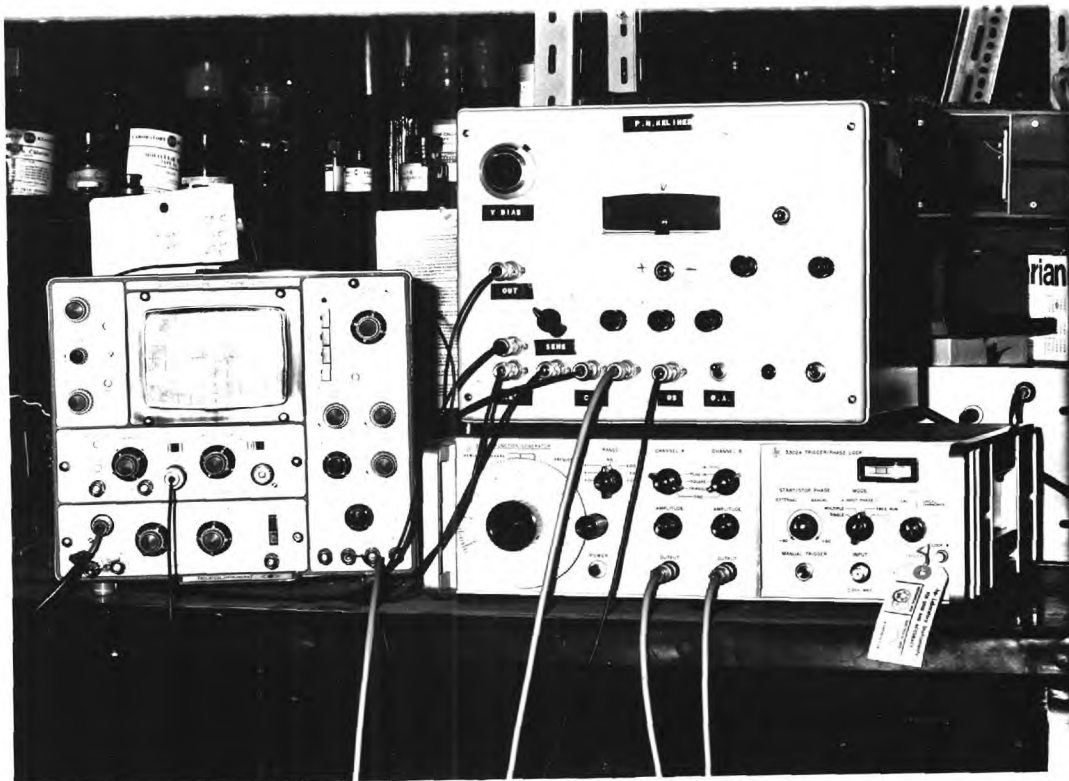

FIGURE 10

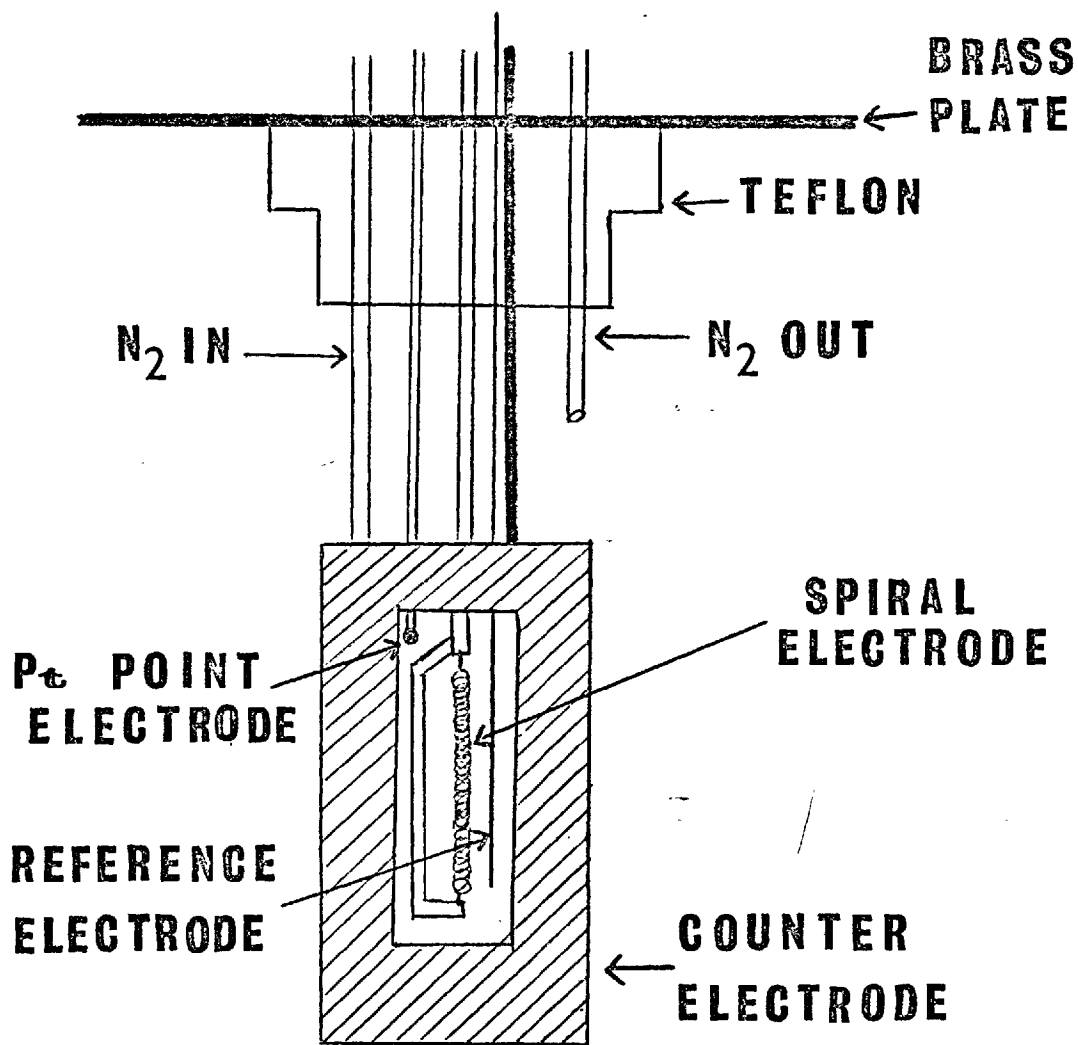

FIGURE 11

The counter electrode used was a platinum sheet (8mm x 20mm) spot-welded to a platinum rod contact. The reference electrode was a silver wire in the same cell. Although the silver electrode is only a pseudo-reference electrode under these conditions, it was found to exhibit a constant potential which could be related to the potential of the S.C.E. An attempt was made to use an S.C.E. as a reference electrode by a saturated TBAP-DMF salt bridge but it was not possible to make this arrangement light tight. The advantage of the reference electrode introduced directly into the cell was that all sorts of junction potential problems, at interfaces of different solutions, were avoided.

ECL from the platinum spiral working electrode was viewed through an aperture (3mm x 15mm) cut into the counter electrode and the arrangement set up in such a way that only light emitted from the working electrode could be viewed through the photomultiplier. This was confirmed visually in the darkened room.

The photomultiplier tube used was an 11-stage EMI 9601B (EMI Electronics Ltd., Hayes, Middlesex) powered by a Model 470 (Brandenburg Ltd., Sanderstead, London) regulated power supply operated at 1000 V, setting to negative.

The photomultiplier photocurrent was displayed on an ultra-sensitive RCA Type WV84C microammeter (RCA, Camden, N.J.) or onto an oscilloscope. Initially a Hewlett-Packard Model 175A was used but this was later replaced by a dual-beam Telequipment Type D53 (Telequipment Ltd., London).

The Type D53 oscilloscope had a long persistence P7 phosphor screen. Two vertical amplifier plug-in units were incorporated into the instrument. The first vertical amplifier was a Type B providing 12 input sensitivities from 1 mV to 5 V/cm. A differential mode was built into this amplifier. This was the amplifier generally used for cyclic voltammetry. The second amplifier, Type J, offered continuous coverage of sensitivities from 100 μ V to 125 V/cm on D.C. This amplifier was generally used for the photomultiplier input. Both amplifiers had internal provision for calibration by a 1 V. peak to peak signal.

The dual-beam oscilloscope was particularly convenient for the work described in this thesis since it allowed simultaneous monitoring of the cyclic voltammetry data and the light output. At relatively slow scan rates light output as discrete peaks could clearly be seen corresponding to the cyclic voltammetry reduction and oxidation peaks. Information from the oscilloscope was either recorded on tracing paper (the long lived phosphor made this very easy) or photographed using Ilford HP3 Hypersensitive Panchromatic Film. A general view of the apparatus is shown in Figure 10.

Fluorescence measurements were made on either a Farrand (Farrand Optical Co., New York, N.Y.) spectrofluorimeter or an Aminco-Bowman (American Instrument Co., Silver Spring, Maryland) spectrofluorimeter. The Aminco-Bowman spectrofluorimeter had a low temperature attachment and phosphoscope (as described on page 22, paragraph 1 of this thesis) and phosphorescence measurements were made using this instrument.

2.3 Reagents

Dimethylformamide (DMF) was used as solvent. Other solvents were considered (acetonitrile, dimethylsulphoxide, diethylformamide, monomethylformamide) but presented no particular advantages. The DMF was dried over anhydrous potassium carbonate and then over a molecular sieve (Linde 5A). The dried solvent was then distilled in a fractional distillation assembly. The distillate was stored in brown glass reagent bottles until required. Karl Fischer titration of the reagent grade DMF showed water content of 280 ppm, no water could be detected in the distillate. The supporting electrolyte was TBAP prepared as described previously.

Oxygen-free nitrogen was dried by passage through concentrated sulphuric acid and then over magnesium perchlorate. The nitrogen was then saturated with DMF before passage into the cell in order to ensure saturation of the nitrogen with solvent and to minimise evaporation of solvent in the sample cell during degassing.

DMF is reported to be non-toxic but it is rapidly transported through the skin. As many of the hydrocarbons studied are reported to be carcinogenic⁴⁷ adequate safety precautions were taken to keep the DMF solutions from touching the skin. This included the use of safety gloves and spill trays. Solutions of possible carcinogens were made up in a fume cupboard.

2.3 Electrochemical Considerations

D.C. polarography is a particular case of a more general voltammetric technique known as linear potential sweep chronoamperometry. In the simplest case, there are two electrodes, one of which is polarisable (the working electrode) and one of which is not (the reference electrode). A system of this sort is conveniently studied by means of current-potential curves. [The term "polarography" is usually taken to mean the particular situation where the working electrode is a dropping mercury electrode]. For solutions of high resistance, such as those encountered in this thesis, it is necessary to use a three electrode system to record current-potential data. The third electrode (the counter electrode) compensates for the IR drop in the system. Practically no current flows between the working electrode and the reference electrode.

The voltammetry of aromatic compounds has been studied by a number of workers¹³. The first reported polarographic studies of the reduction of polycyclic aromatic hydrocarbons were carried out with 75% dioxane-water.⁵⁸ A clear indication and formulation of the mechanism of the reduction process came some time later. Hoijtink et al⁵⁹ conducted polarographic experiments in aprotic media (96% dioxane-water, DMF, and AN) and found that generally two reduction waves could be observed. The limiting diffusion current for each wave corresponded to the transfer of one electron. The waves represented, respectively, the

reversible one-electron reduction of the hydrocarbon to its radical anion and the more difficult reduction of the radical anion to its dianion. This is illustrated below for anthracene.

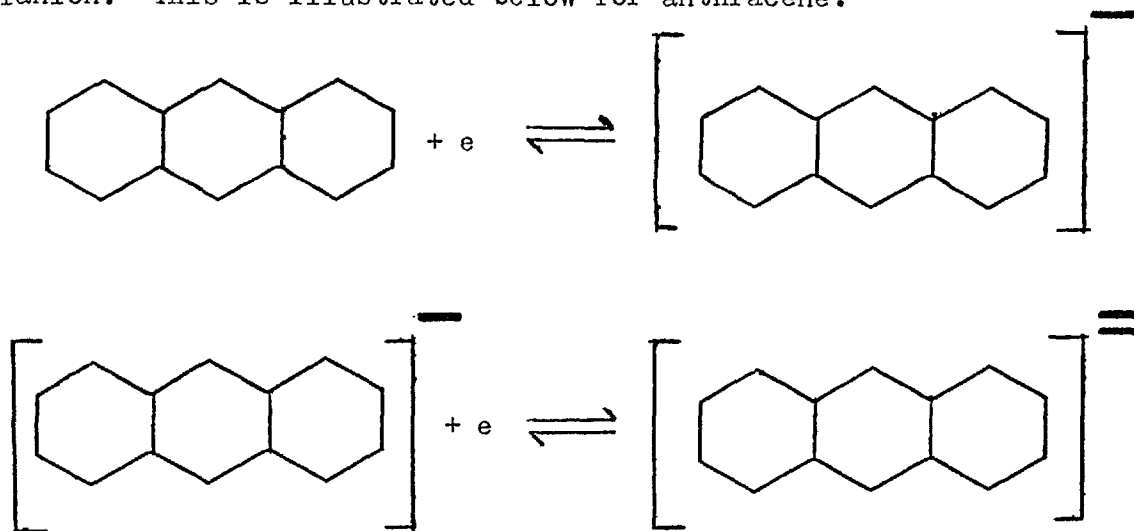

An indication of the reversibility of this reaction under the cell conditions employed was made by adding a small amount of a proton donor, 10^{-2} M acetic acid in DMF, to a solution of $5 \cdot 10^{-4}$ M anthracene in 10^{-2} M TBAP in DMF. The deoxygenated solution before addition of proton donor clearly showed two reduction peaks at -2.0 V and -2.65 V vs. the Ag reference electrode. After addition of proton donor, the height of the first peak was approximately doubled and the second peak had disappeared. This indicated reversibility for the first reduction and irreversibility for the second reduction. Hoijtink⁶⁰ has suggested that this is probably due to,

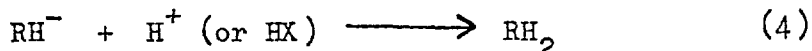
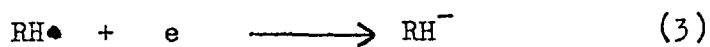
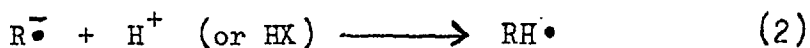
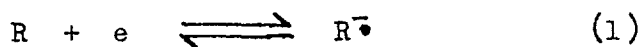

Bergman⁶¹ has indicated that if electrolysis of anthracene (in DMF but not necessarily in all other solvents) is performed at the potential corresponding to the top of the first one-electron wave the final product will be 9,10-dihydroanthracene. In this case reaction (3) would be replaced by,

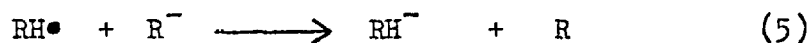

Bergman^{62,63} has reported polarographic data vs. a mercury pool electrode for a wide variety of aromatic compounds.

A recent development of linear potential sweep methods has been to apply a continuously cycling triangular wave (cyclic voltammetry) and much of the work has been with electrodes of fixed area⁶⁴. Two kinds of behaviour may be distinguished with electrodes of fixed area depending on whether the electrode and solution are stationary with respect to each other or not. If the electrode is rotated or the solution stirred (as with a stream of nitrogen) the supply of electroactive material at the electrode is continuously renewed. The behaviour of a stationary electrode in a quiet solution is quite different. At a constant potential the reduction (or oxidation) of an electroactive substance then depletes a layer of solution that extends further and further from the electrode as time goes on, and the current decreases as a result. For slow sweep rates it has been shown that the peak potential (E_p) is related to the ordinary half-wave polarographic

potential ($E_{1/2}$) by the following expression,^{64,65}

$$E_p = E_{1/2} - 1.1 \frac{RT}{nF}$$

which at 25° C becomes

$$E_p = E_{1/2} - \frac{0.028}{n} \quad (\text{in volts})$$

The value of the current at the peak potential for a reversible system is given by an equation which was derived independently by Randles⁶⁶ and Sevcik⁶⁷ and is usually referred to as the Randles-Sevcik equation.

$$i_p = 2.687 \times 10^5 n^{3/2} A D^{1/2} C V^{1/2}$$

where V is the potential sweep rate (in V/sec), D is the ordinary polarographic diffusion coefficient, A is the area of the electrode (in square cm), and C is the bulk concentration of electroactive species in millimoles per litre. For any particular cell system (electroactive species concentration, supporting electrolyte concentration, solvent, reference electrode, etc.) the equation may be reduced to

$$i_p \propto V^{1/2}$$

This equation provided a useful check for the reversibility of the first anthracene wave in the cell system employed. Single scans were run from - 0.5 V to - 2.5 V at a variety of sweep rates.

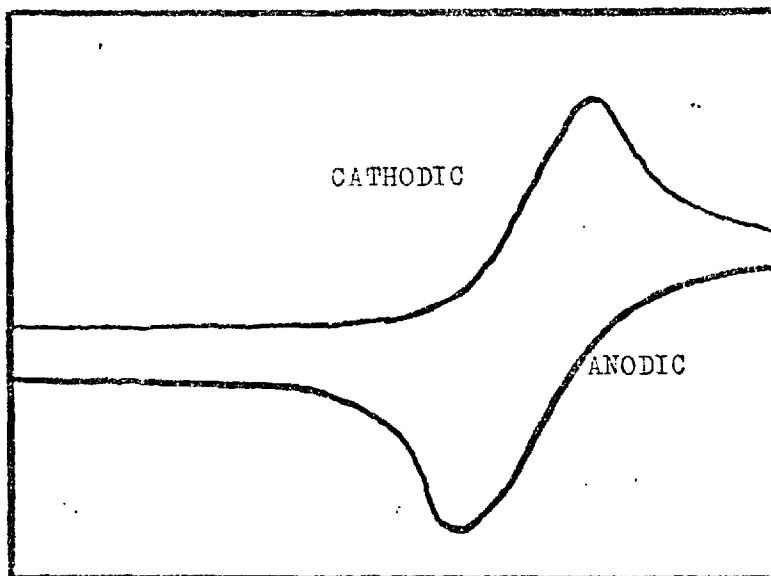

FIGURE 12

Single sweep voltammogram between -0.5 V and -2.5 V for $5 \cdot 10^{-4}$ M anthracene in 10^{-2} M TBAP-DMF. Unstirred solution. Sweep rate 1 Hz.

A typical voltammogram is shown in Figure 12 and the scan rate conversion considerations are shown in Table 5. Relationships between peak height and scan rate are shown in Figures 13 and 14.

TABLE 5 - Scan Rates		
Hz	V/sec	$(V/sec)^{1/2}$
.05	.20	.45
.25	1.0	1.0
.5	2.0	1.42
1.0	4.0	2.0
2.5	10.0	3.2
5.0	20.0	4.5

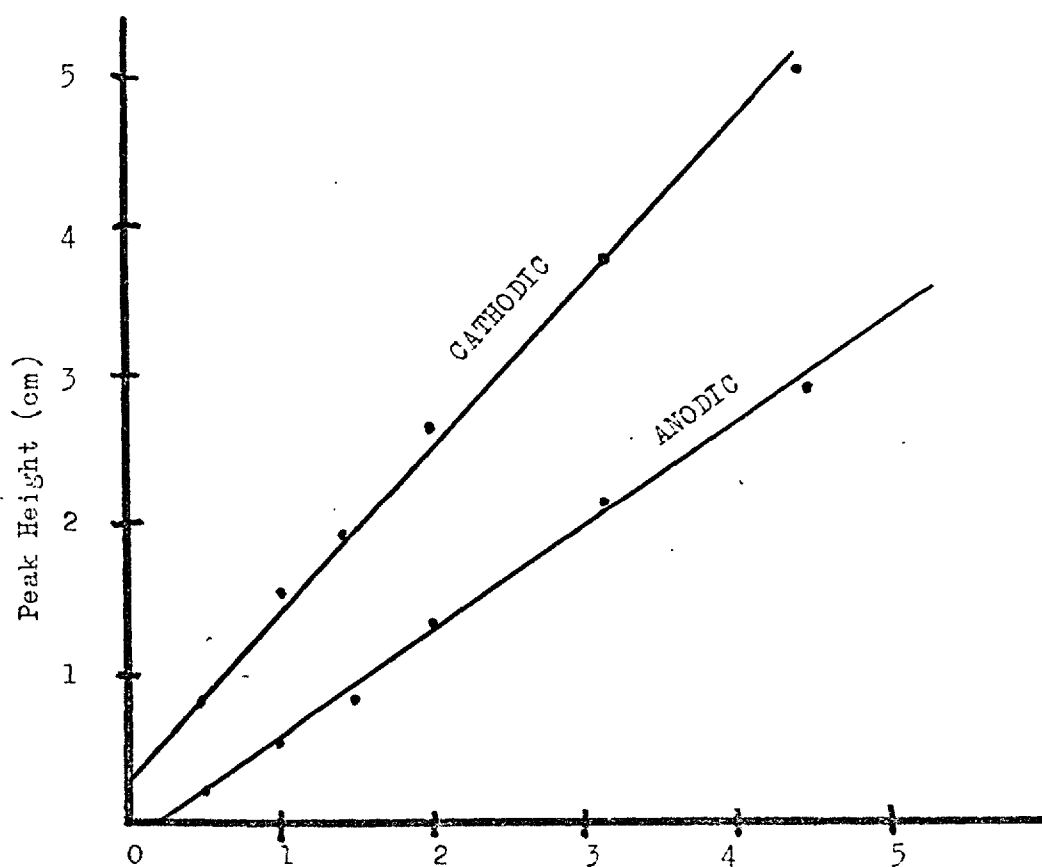

FIGURE 13. Relationship between peak height and scan rate $(V/sec)^{1/2}$ for cathodic and anodic processes in unstirred solution.

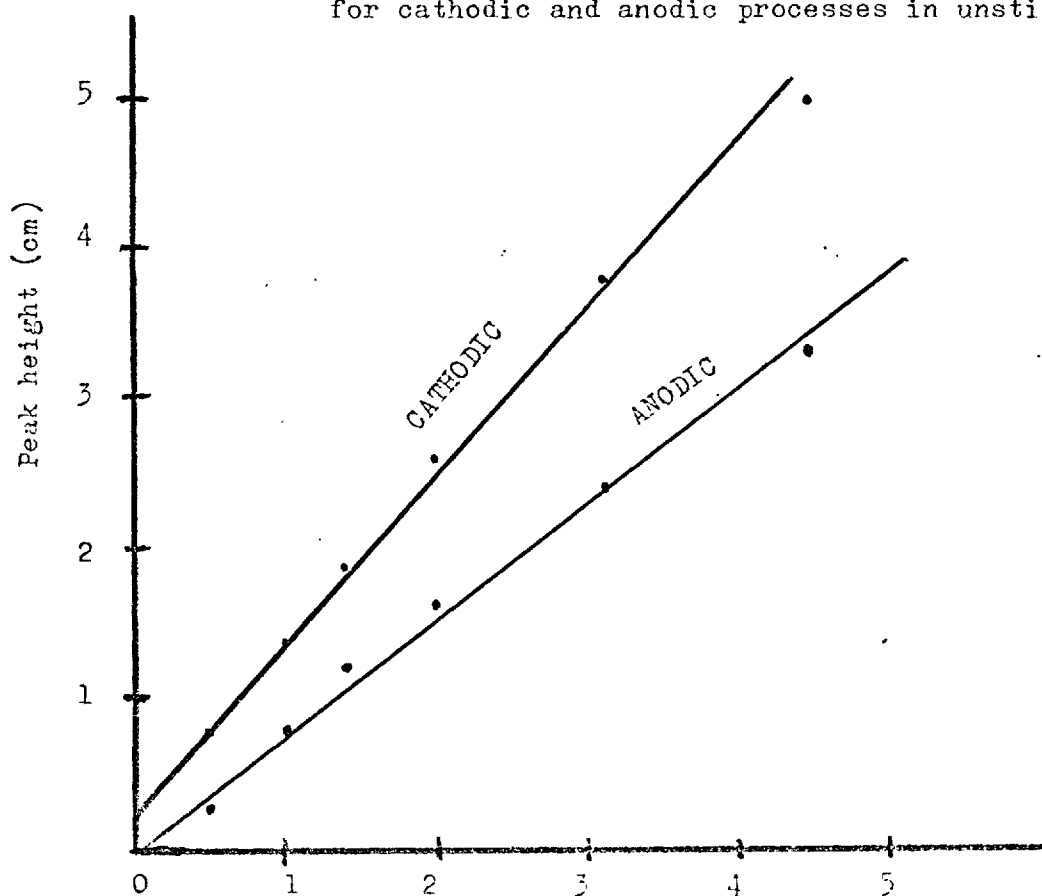

FIGURE 14. Relationship between peak height and scan rate $(V/sec)^{1/2}$ for cathodic and anodic processes in stirred solution.

The linear relationship between i_p and C may also be noted here, all other factors being constant. The dependence of i_p on $V^{1/2}$ suggests that for maximum sensitivity a fast scan rate should be used. At very high scan rates, however, the current is completely masked.

Voltammetric oxidation characteristics are generally more complicated than reduction characteristics. Most of the aromatic hydrocarbons considered gave relatively well defined reduction peaks, oxidation peaks were generally obscure. Among the simple aromatic hydrocarbons only DPA has been found to show oxidation behaviour comparable in simplicity to the reduction behaviour under normal voltammetric conditions. Peover¹³ has found DPA to show two well defined one-electron oxidation waves in AN with a rotating platinum electrode. The electrochemistry of aromatic compounds was studied in this thesis only as related to the light output at the moment of reduction or oxidation (where it could be observed) for any particular compound. Figure 15 shows a cyclic voltammogram for $5 \cdot 10^{-4}$ M rubrene in a stirred solution at a sweep rate of 1 Hz, $0 \longrightarrow -2.0$ V vs. the Ag reference electrode. Light output is shown in the bottom trace and can clearly be seen to occur where the rubrene is reduced. In unstirred solution under the same conditions (Figure 16) the light output is less sharp but more intense. Rubrene exhibited exceptional behaviour in that light could be seen by cycling in one direction only, i.e. positive sweeps were not necessary.

When potential scans were made over large potential ranges, reduction and oxidation peaks caused by product formation at very negative and positive potentials could be observed in the range $+1.0 \longrightarrow -0.5$ V. These peaks were dependent on sweep rate and were much more pronounced in non-stirred solution indicating buildup of these products around the electrode. They did not interfere with light output, however, and were not observed to obscure any reduction peaks.

Cyclic voltammograms for $5 \cdot 10^{-4}$ M DPA over the range $+1.6 \longrightarrow -2.4$ V in unstirred solution are shown in Figures 17 (1 Hz), 18 (2 Hz), 19 (5 Hz), and 20 (10 Hz). Light intensity at the radical anion peak decayed sharply above 5 Hz and became greater at the radical cation peak.

Figures 21 and 22 both show cyclic voltammograms for $5 \cdot 10^{-4}$ M benzo (b) fluoranthene at a sweep rate of 2 Hz over the range $+2.2 \longrightarrow -2.2$ V. Figure 21 is for a stirred solution, however, and Figure 22 was taken immediately after stirring was stopped. A sharp light/peak was observed at the reduction peak (-1.7 V) of this compound but this rapidly decayed over about ten scans to reach the steady low intensity value of a stirred solution as seen in Figure 21. The decay is shown in Figure 23. No cation oxidation peak could be observed for the case of benzo (b) fluoranthene but ECL was observed at $+2.2$ V. If the positive scan did not extend at least to $+2.2$ V no ECL could be observed in either stirred or unstirred solution. This would indicate a reaction between the radical anion and products produced by oxidation of the solvent.

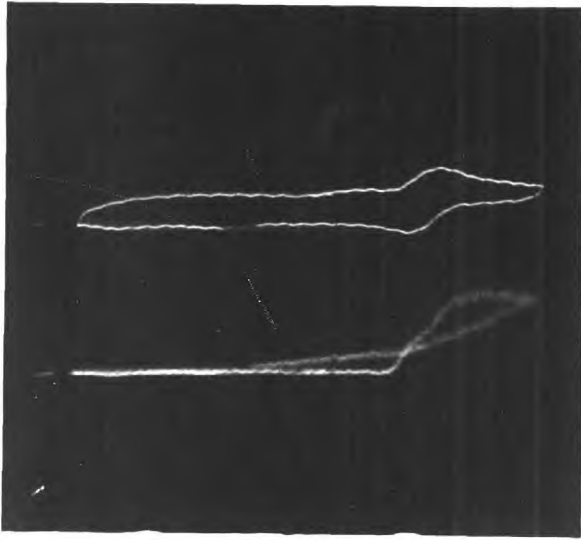

FIGURE 15

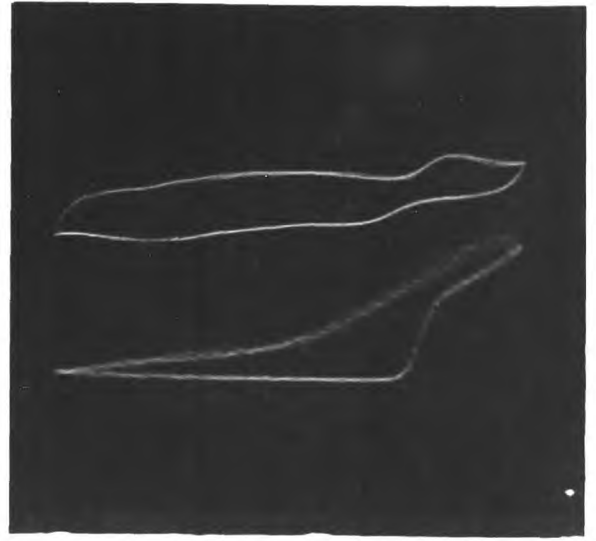

FIGURE 16

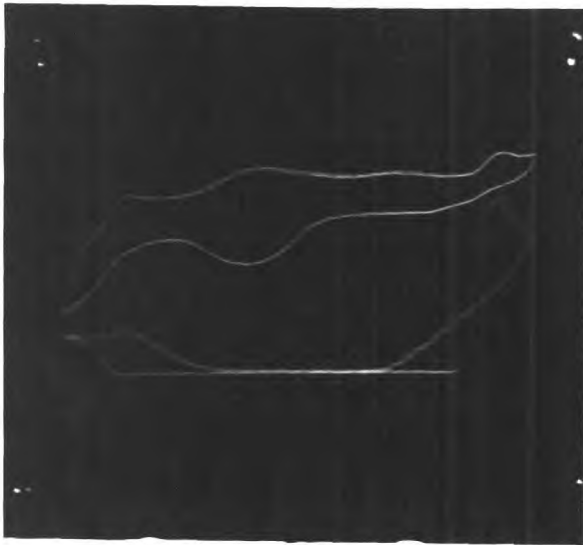

FIGURE 17

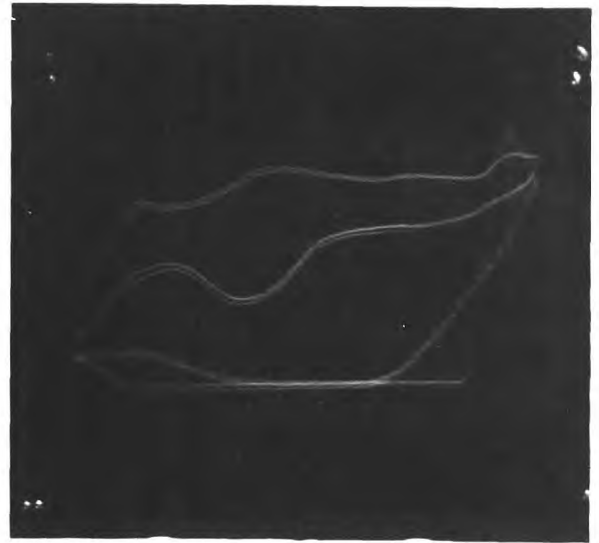

FIGURE 18

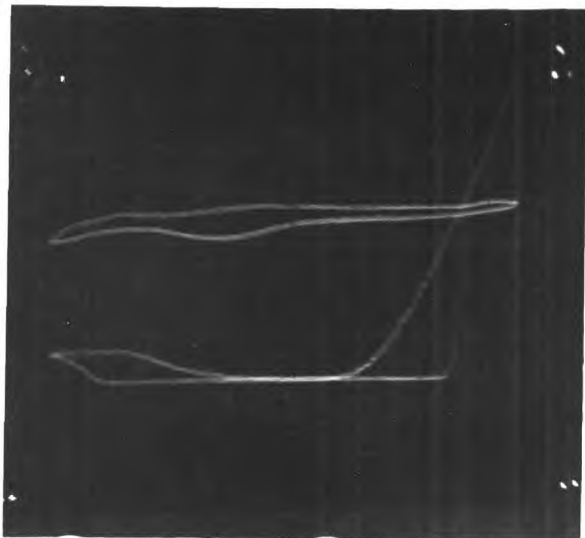

FIGURE 19

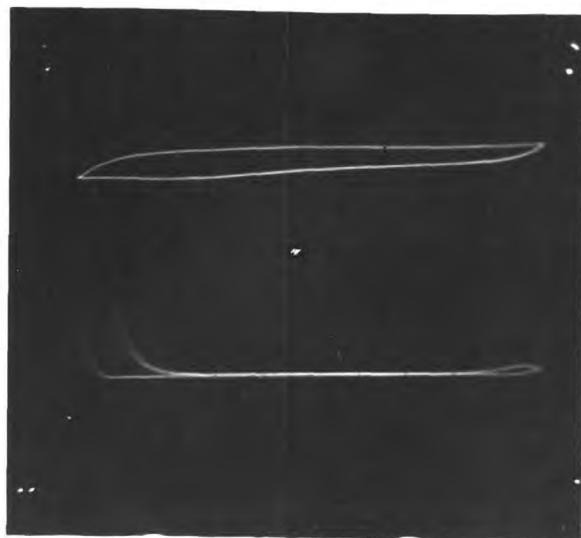

FIGURE 20

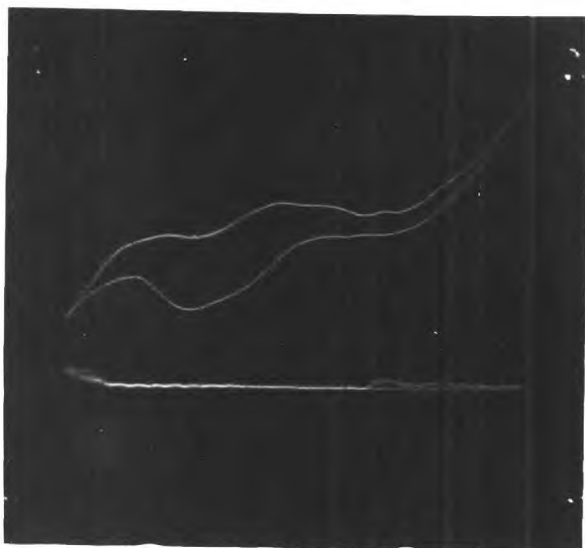

FIGURE 21

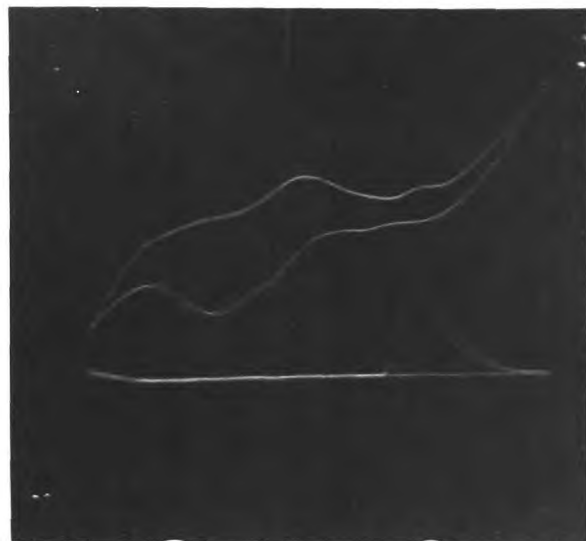

FIGURE 22

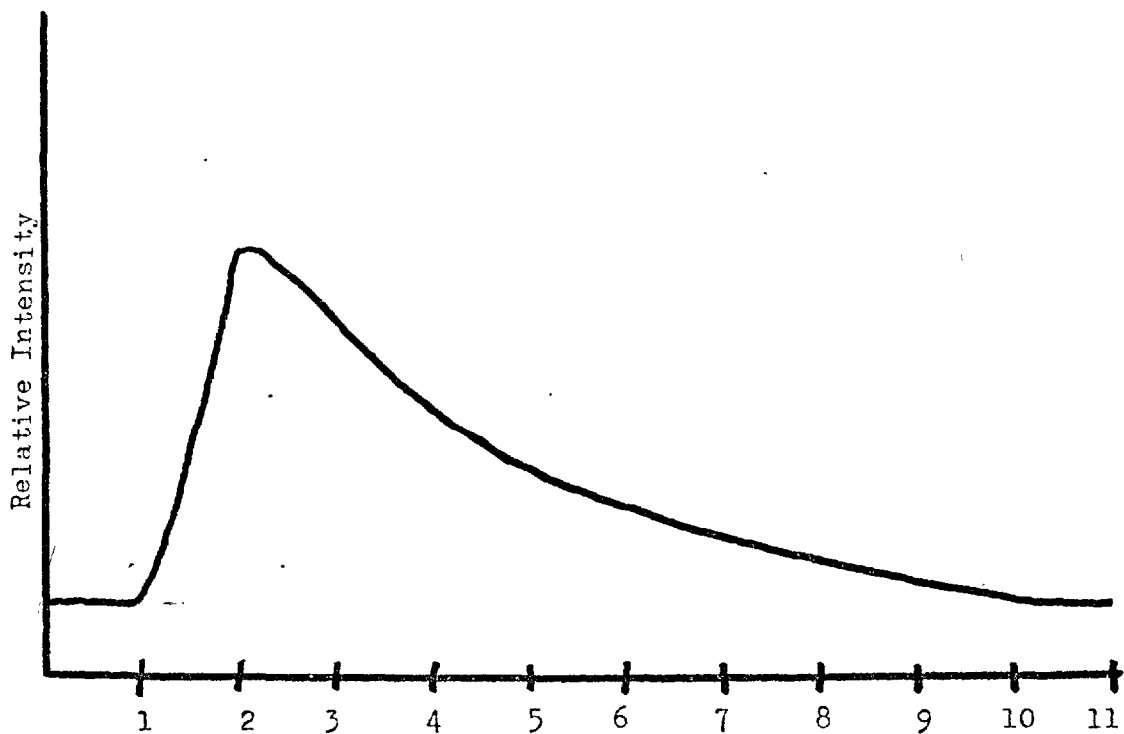

FIGURE 23. Complete sweeps after stirring is stopped vs. light intensity for benzo (b) fluoranthene.

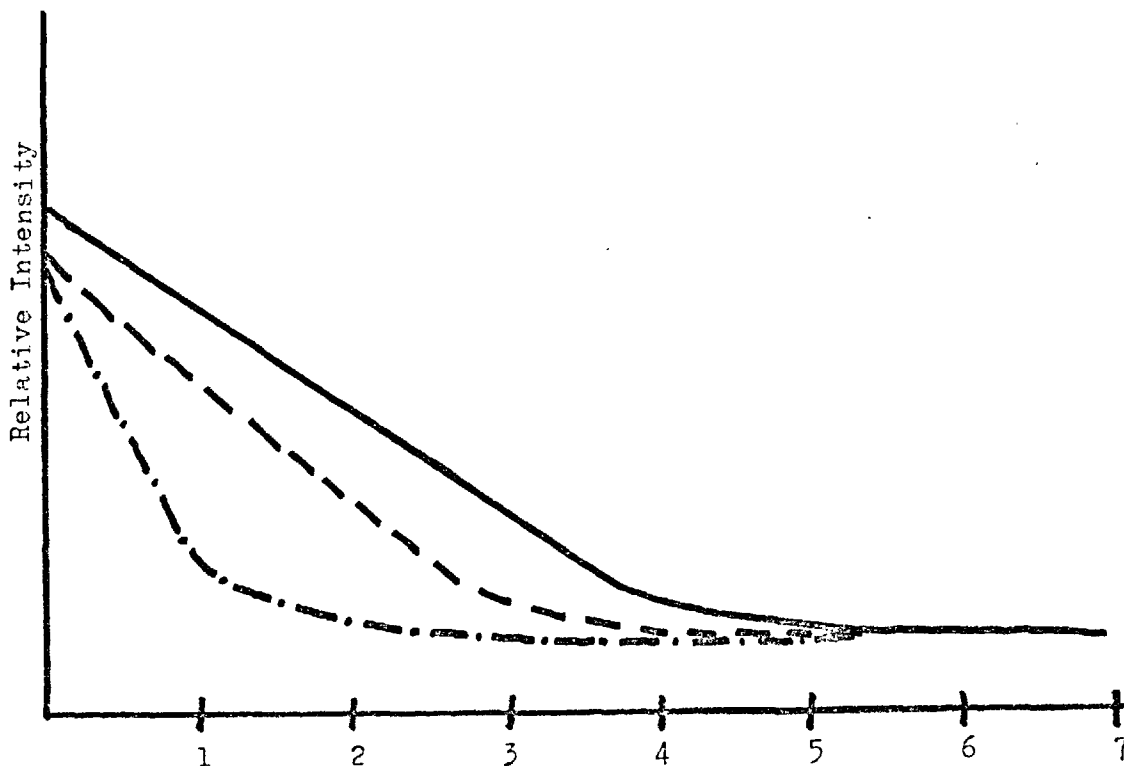

FIGURE 24. Complete sweeps after stirring is stopped vs. light intensity for DPA. A) 1 Hz; B).5 Hz; C) .1 Hz.

For DPA, however, ECL intensity was found to decrease when stirring was stopped. The rate of decrease was dependent upon the sweep rate as shown in Figure 24 for $5 \cdot 10^{-4}$ M DPA over the range $+ 1.6 \longrightarrow - 2.4$ V. The decrease was identical for both the light output on the radical anion and the radical cation. It is likely that in this particular case, where the radical ions are relatively stable, that diffusion of ions from the counter electrode causes the more intense ECL in the stirred solution. This would not be the case for benzo (b) fluoranthene where no radical cation could be detected.

2.4 Intensity-Potential Relationships

The lowest potential at which ECL emission could be detected was found to vary widely from compound to compound and to be very interdependent upon the other variables, in particular, wave-form and sweep rate. Figure 25 shows intensity of 10^{-3} M DPA as a function of potential about zero using a 30 Hz wave. The rise in intensity was roughly linear between 2.0 and 2.4 V and then sloped off.

2.5 Intensity-Sweep Rate Relationships

The intensity vs. sweep rate for any particular wave-form and potential condition was also found to vary widely from compound to compound. Figures 26-29 show sweep rates for $5 \cdot 10^{-4}$ M benzo (b) fluoranthene in unstirred solution. Figure 26 (10 Hz), 27 (20 Hz), 28 (30 Hz), 29 (40 Hz). In this particular case it was found that the light intensity decreased linearly over the range considered, above 50 Hz no light could be detected under these potential conditions (± 2.2 V) with a triangular wave. Under

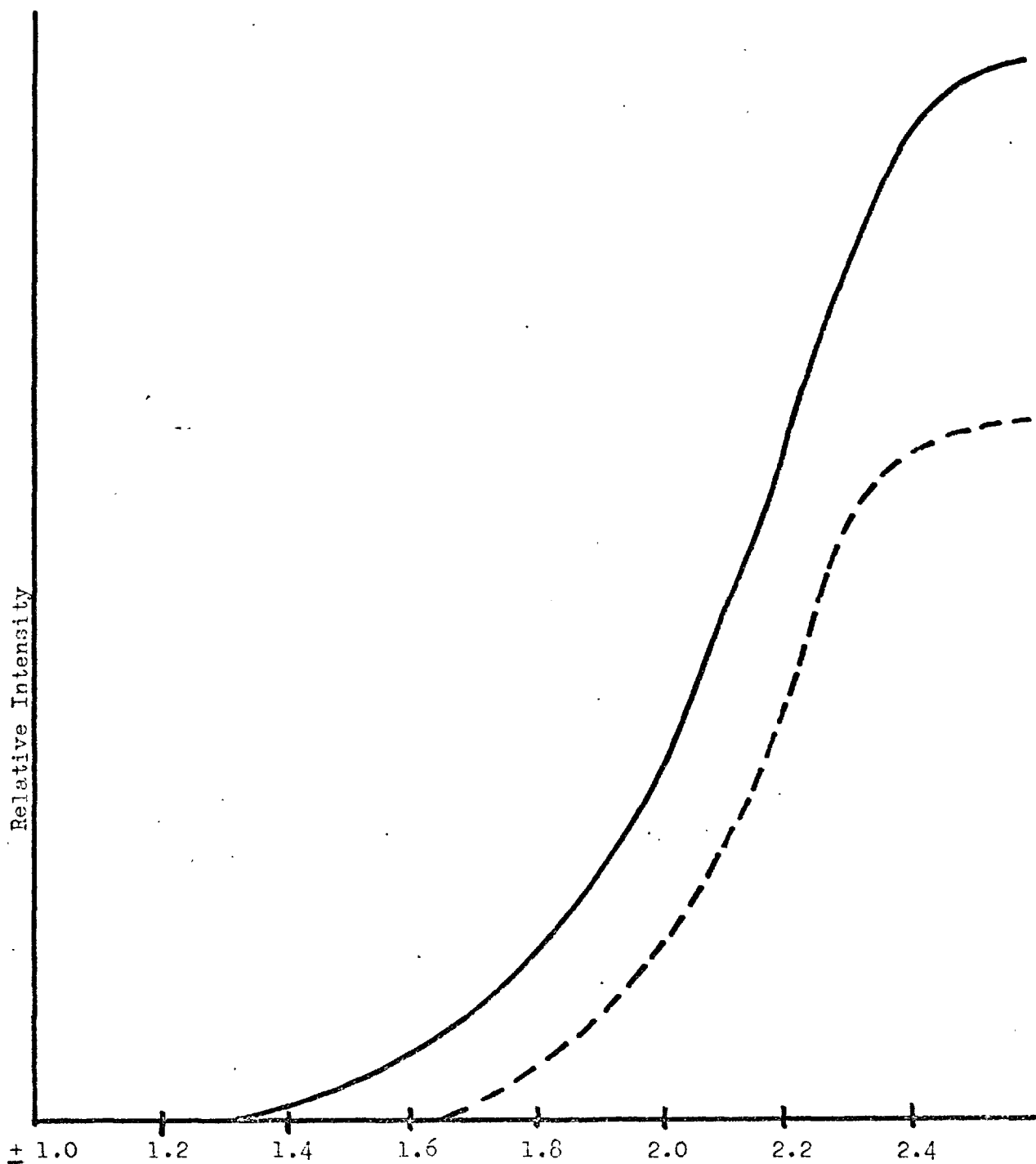

FIGURE 25. Intensity of 10^{-3} M DPA as a function of potential about zero. A) 30 Hz square wave; B) 30 Hz triangular wave.

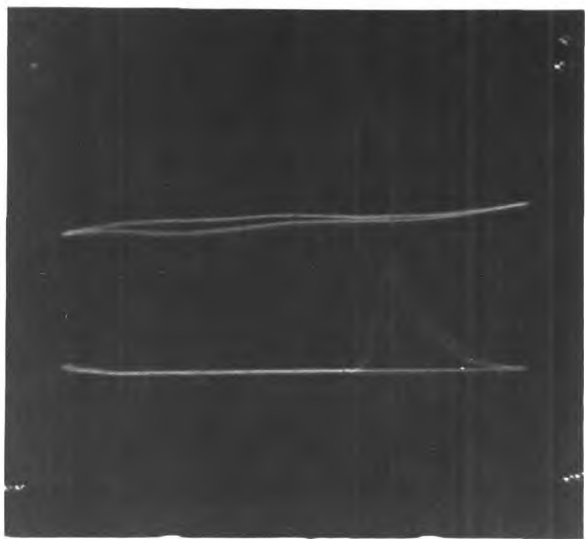

FIGURE 26

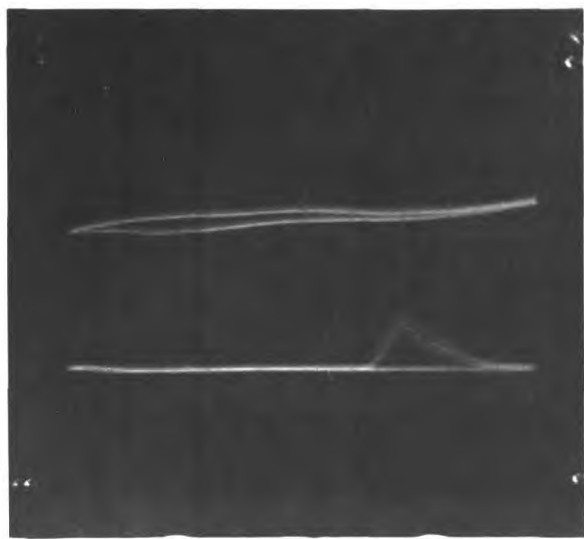

FIGURE 27

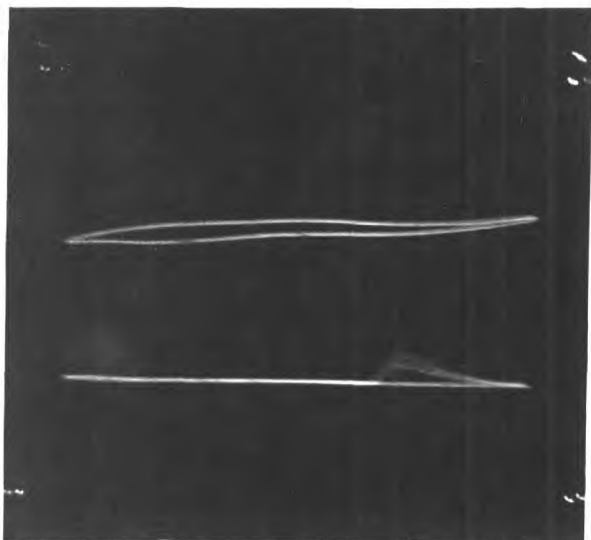

FIGURE 28

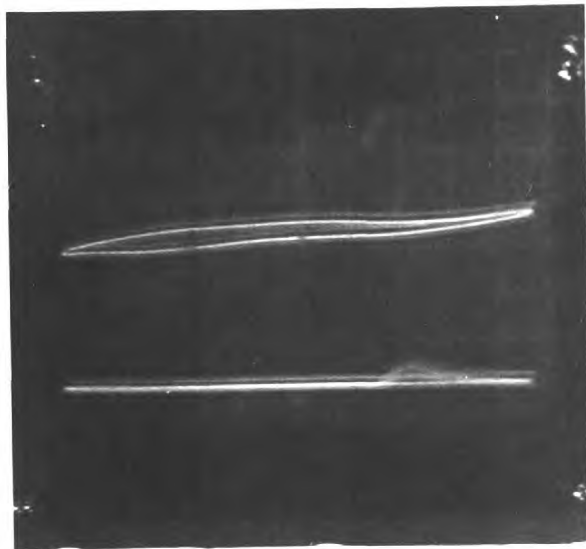

FIGURE 29

square-wave conditions, however, (but under the same potential conditions) ECL was greater at 40 Hz (Figure 31) than at 10 Hz (Figure 30).

The relative amounts of light output were also found to be dependent upon sweep rate. Figure 32 shows light intensity for 5.10^{-4} M DPA in stirred solution (contrast this with Figure 20 - unstirred solution) over the + 1.6 \longrightarrow - 2.4 V range. Figure 33 is taken at 20 Hz under otherwise identical conditions. The "total ECL intensity" is about the same (from consideration of Figures 32 and 33 and measurement of signal on the microammeter) but the relative amounts of light at each peak have changed.

2.6 Intensity- Time Relationships

For most compounds, it was observed that when the potential was applied to the ECL cell, intensity rose to a peak and then decayed, reaching a steady value (at least for several minutes) within 5-30 seconds depending upon sweep rate and potential conditions. Rubrene and rubicene did not show this usual behaviour but almost immediately assumed a steady value. This observation (for rubrene) has also recently been noted by Cruser and Bard⁶⁸.

Over long time periods there was a general decay of ECL for aromatic hydrocarbons at the wavelength where the original ECL was observed. For several compounds there was a buildup of ECL intensity at other wavelengths, this is considered further in the following chapter. Decay of phenanthrene ECL is shown in Figure 34.

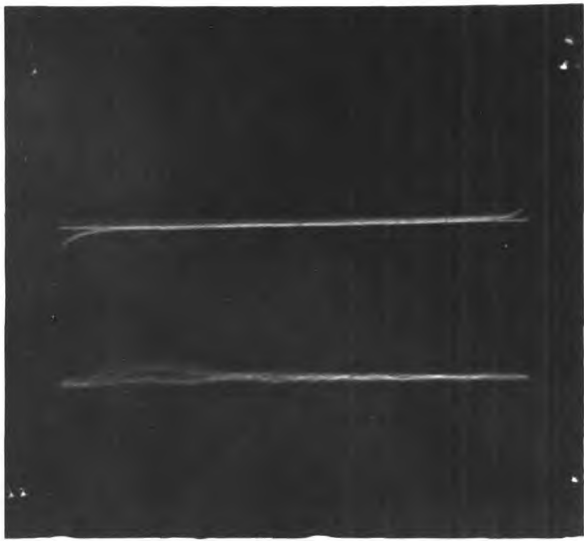

FIGURE 30

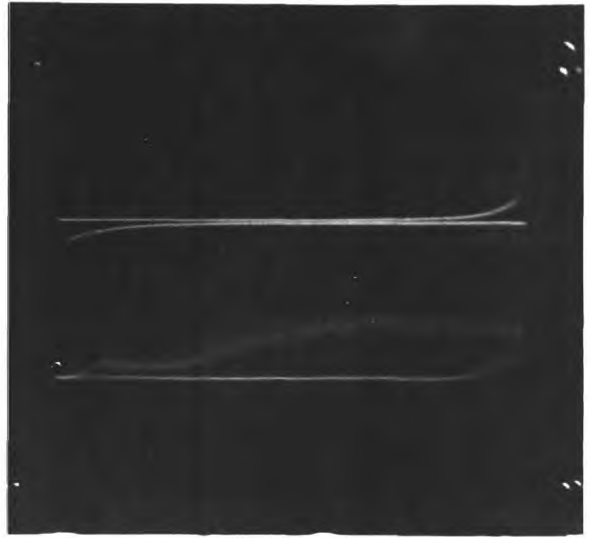

FIGURE 31

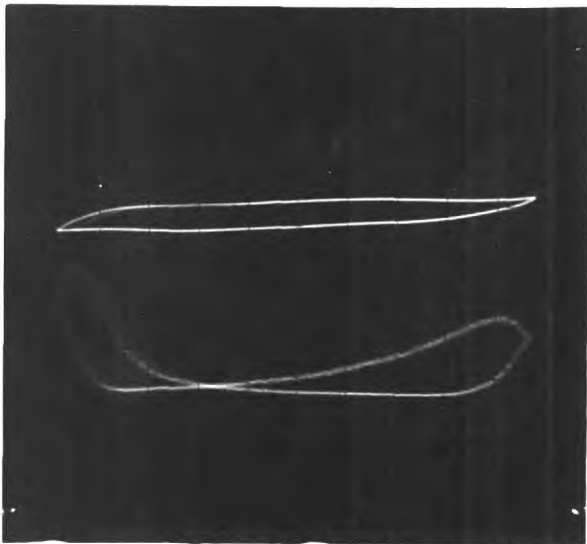

FIGURE 32



FIGURE 33

Relative Intensity

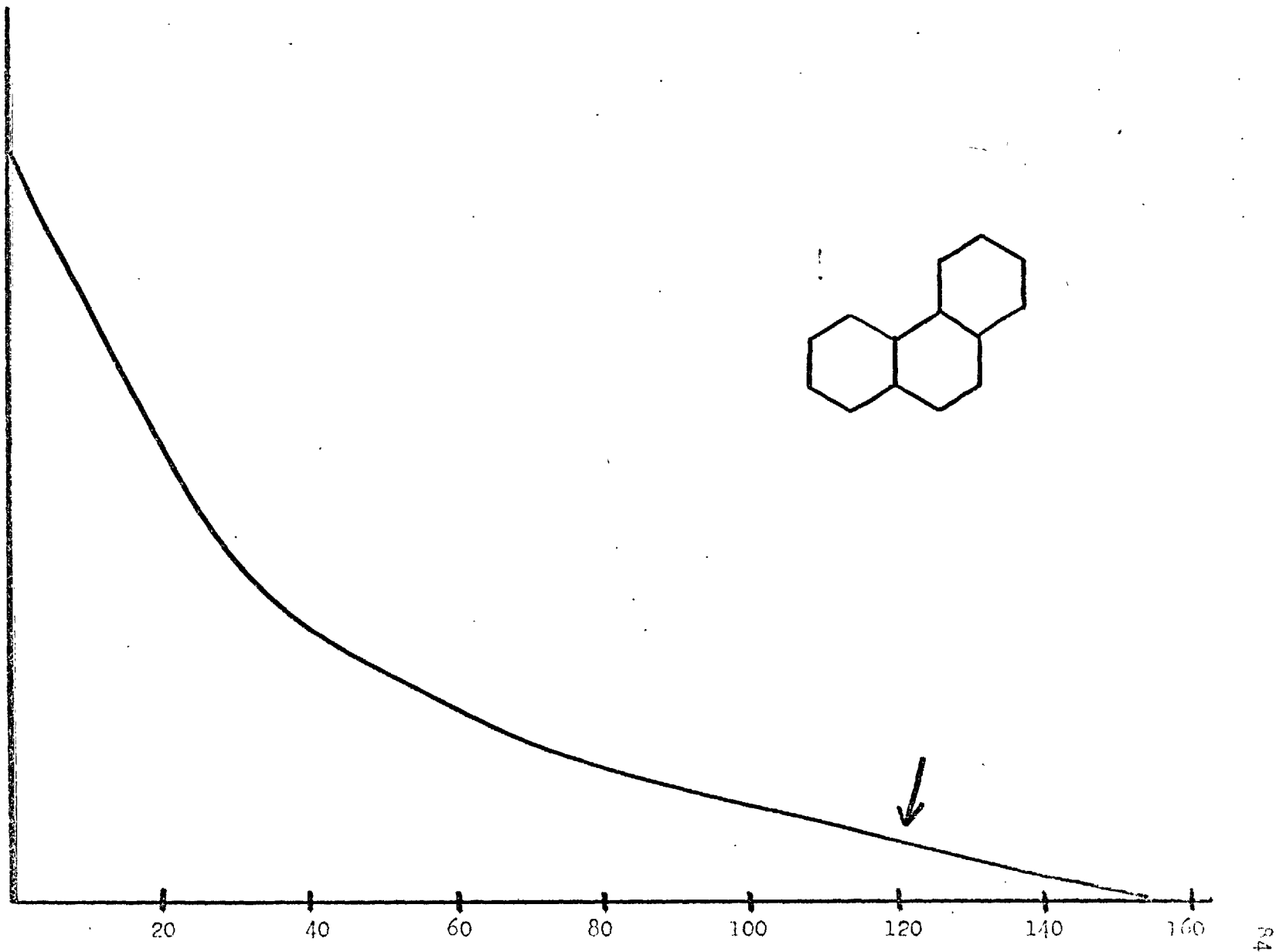

FIGURE 34. Decay of phenanthrene ECL (510 nm) in a stirred solution, 3.0 V square wave, 30 Hz. Arrow indicates point where electrodes were cleaned. Time in minutes.

It was confirmed that the ECL decay was not a function of the age of the solution, all compounds were stable in 10^{-2} M TBAP-DMF, at least for several hours.

To confirm that the decay of ECL was not a function of electrode corrosion, the solution was removed from the cell at the end of two hours and the electrodes thoroughly cleaned, and then dried. When the original solution was replaced, no difference was observed.

CHAPTER THREEECL SPECTRAL DATA

This chapter presents spectral data for a wide variety of compounds under the most ideal conditions of waveform, potential and sweep rate, these being indicated in Table 6. ECL spectra were compared with pre- and post-ECL fluorescence spectra. Unless otherwise noted, electrolysis time was one hour. Solutions are 10^{-3} M emitter in 10^{-2} M TBAP. About 3-5 minutes were allowed for nitrogen purging.

Bard and his co-workers¹¹ have distinguished between three general types of behaviour to describe ECL-fluorescence spectrum relationships. Although not all-encompassing, it does provide a useful simple classification. Type I behaviour refers to compounds which have similar ECL and fluorescence spectra and in which there is no change in the shape of the spectrum with time. Type II behaviour describes compounds where there are ECL and fluorescence spectra shifts with electrolysis time. Bard puts phenanthrene, trans-stilbene, anthracene, and benz(a)anthracene into this category. The shifts for these compounds, however, are not very clearly established (except for the case of anthracene) and in any case are very dependent upon the applied potential. Bard describes Type III behaviour as the condition where pre- and post- ECL fluorescence spectra are at the same wavelength, but ECL spectra at longer wavelengths.

FIGURE 35 --- ANTHRACENE

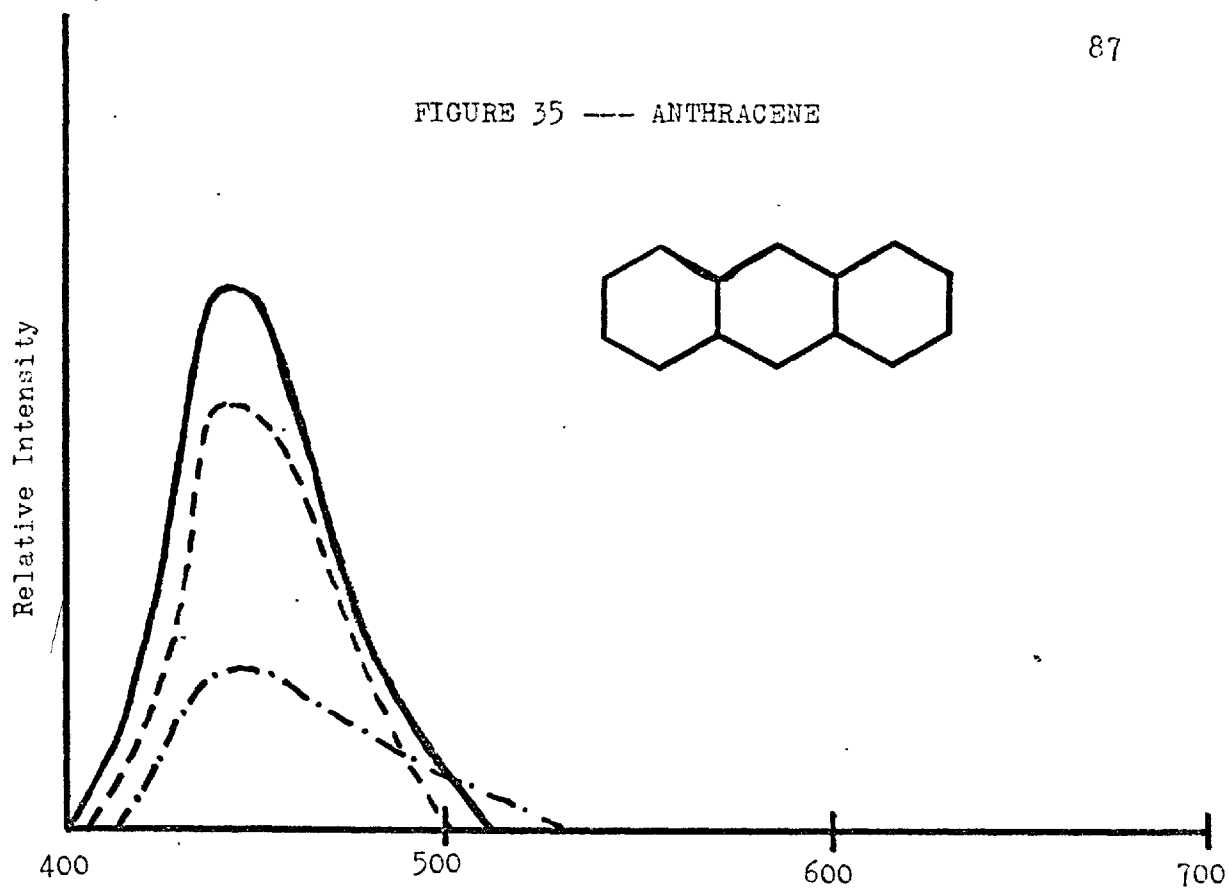

FIGURE 36 --- 9,10 - DIPHENYLANTHRACENE (DPA)

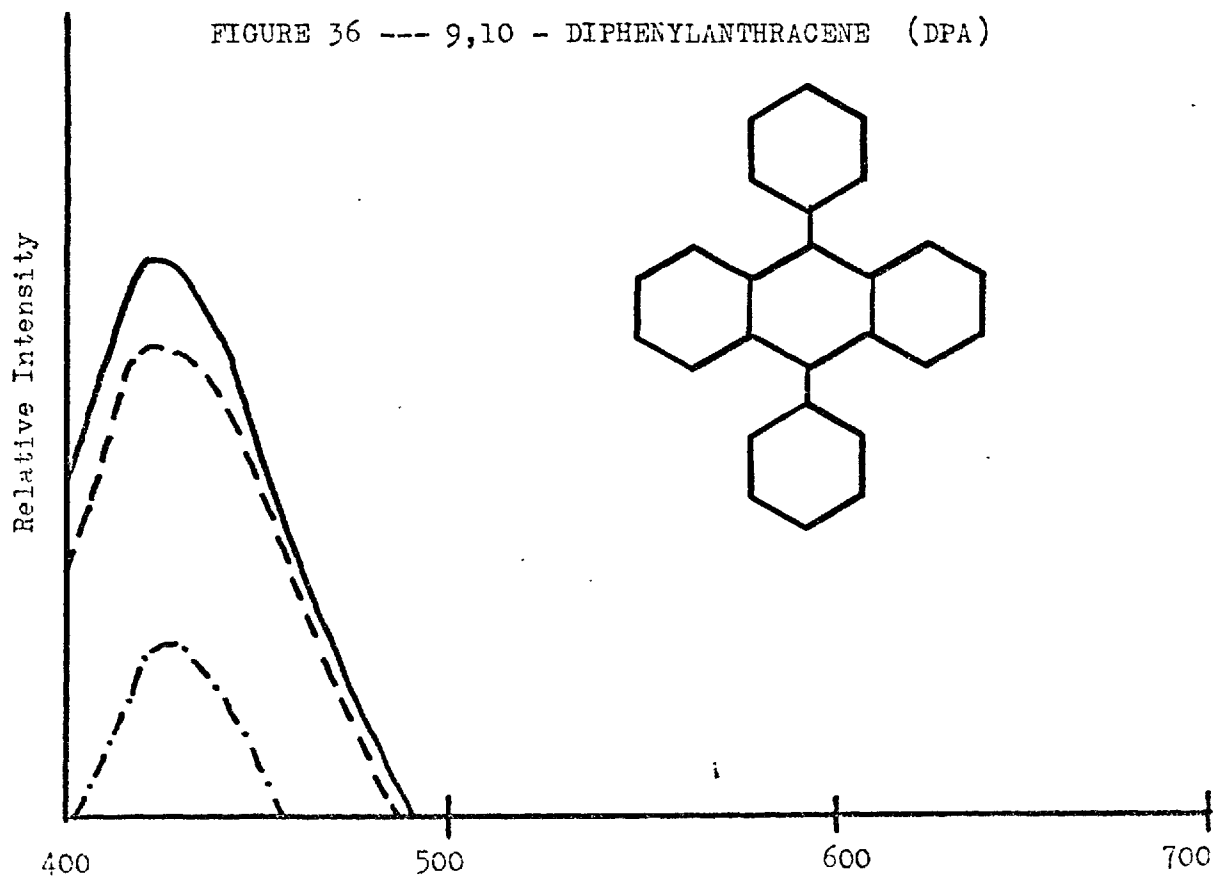

FIGURE 37 --- 9-PHENYLANTHRACENE

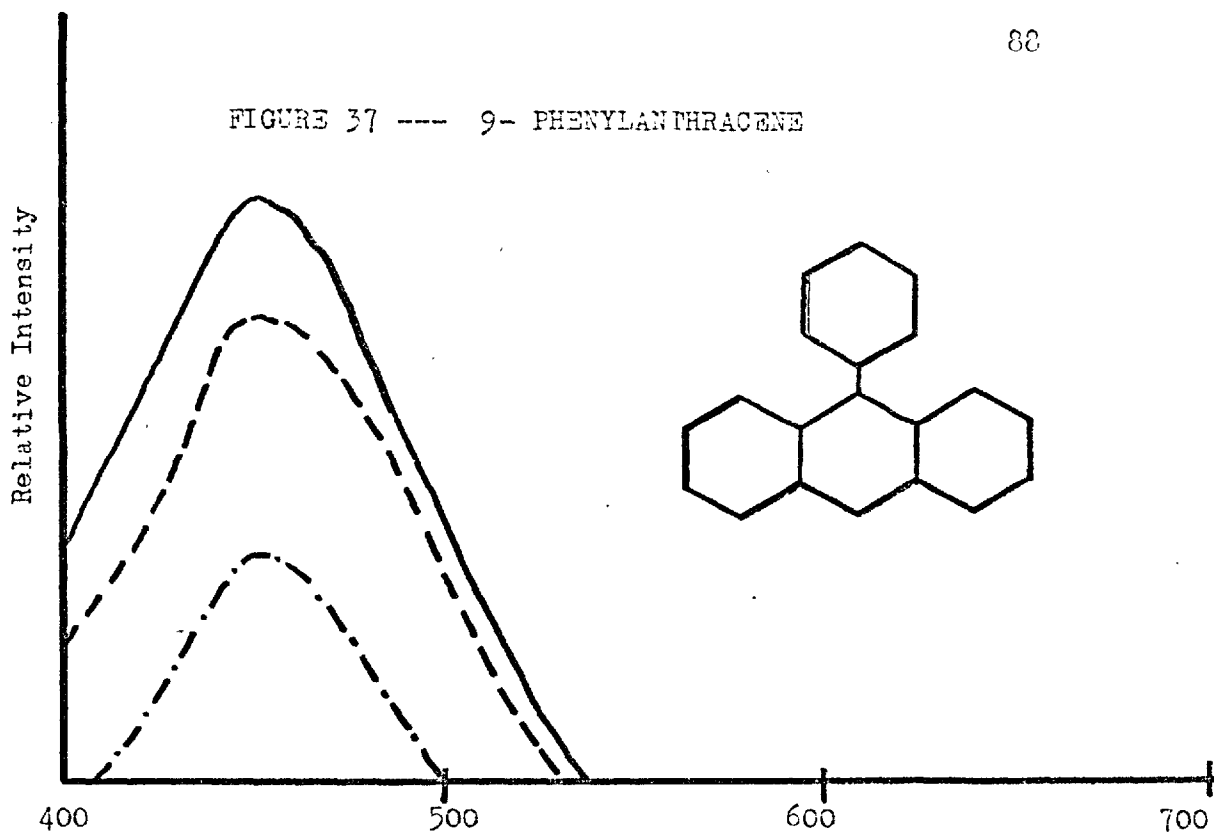
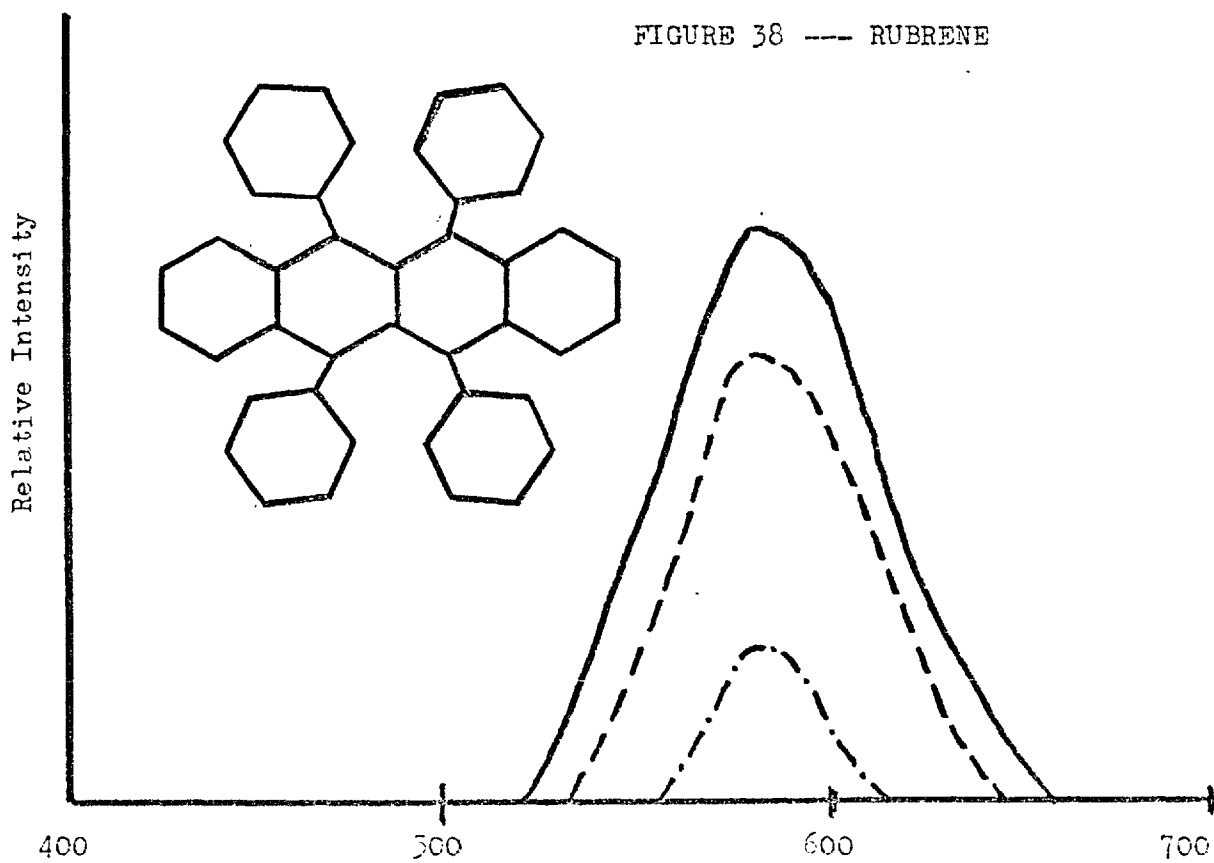

FIGURE 38 --- RUBRENE



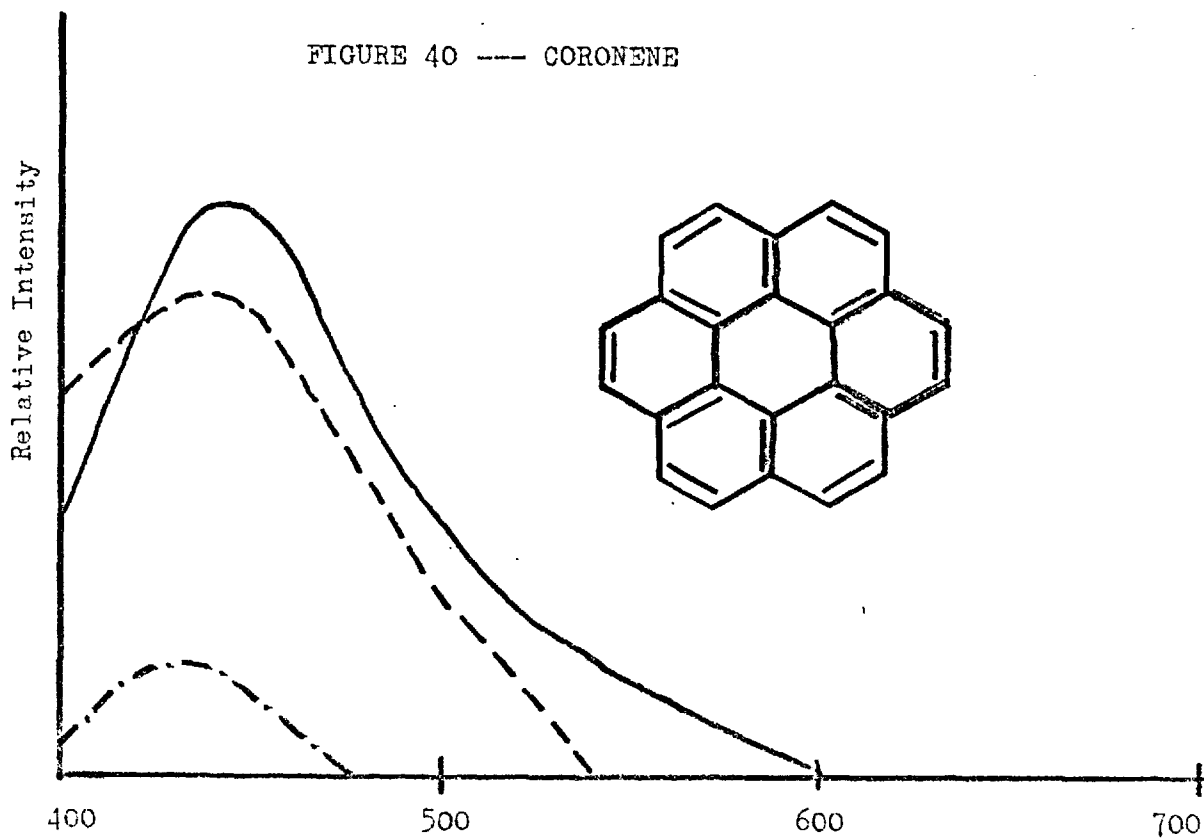
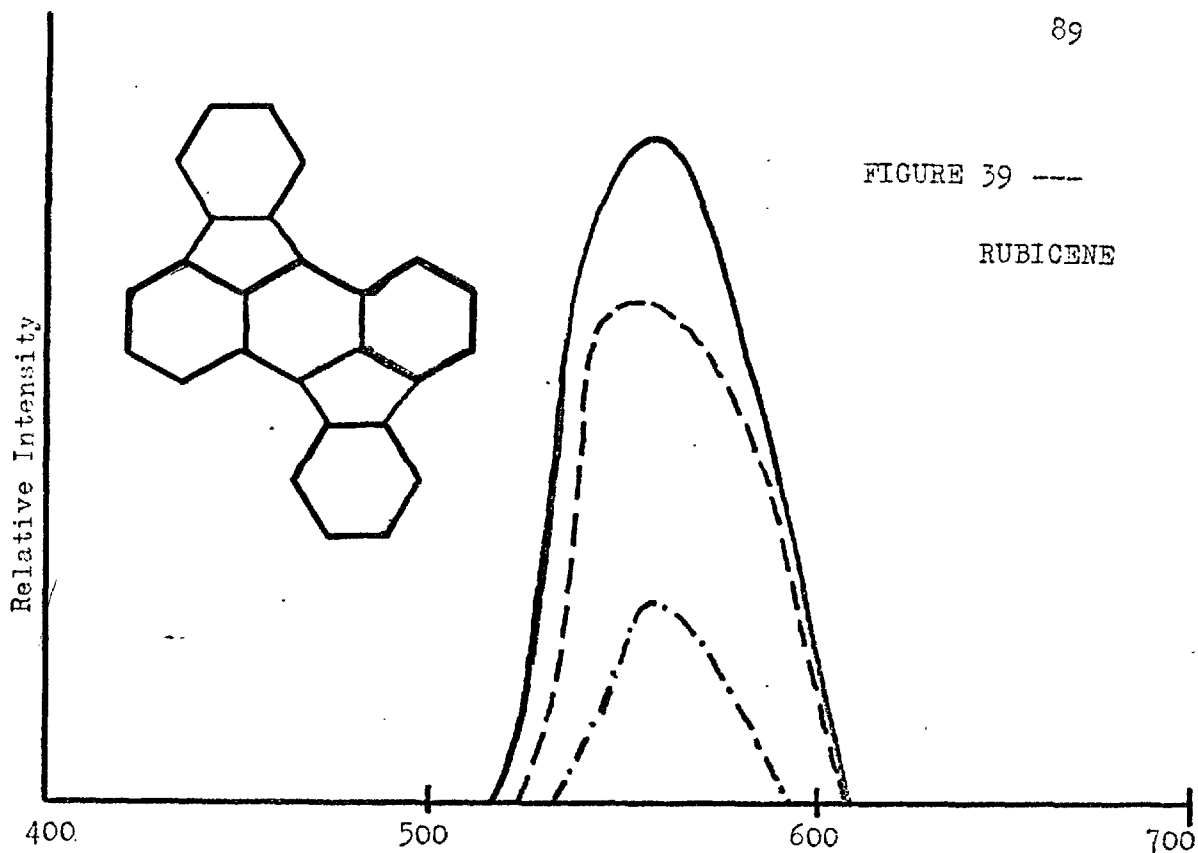

FIGURE 41 --- PERYLENE

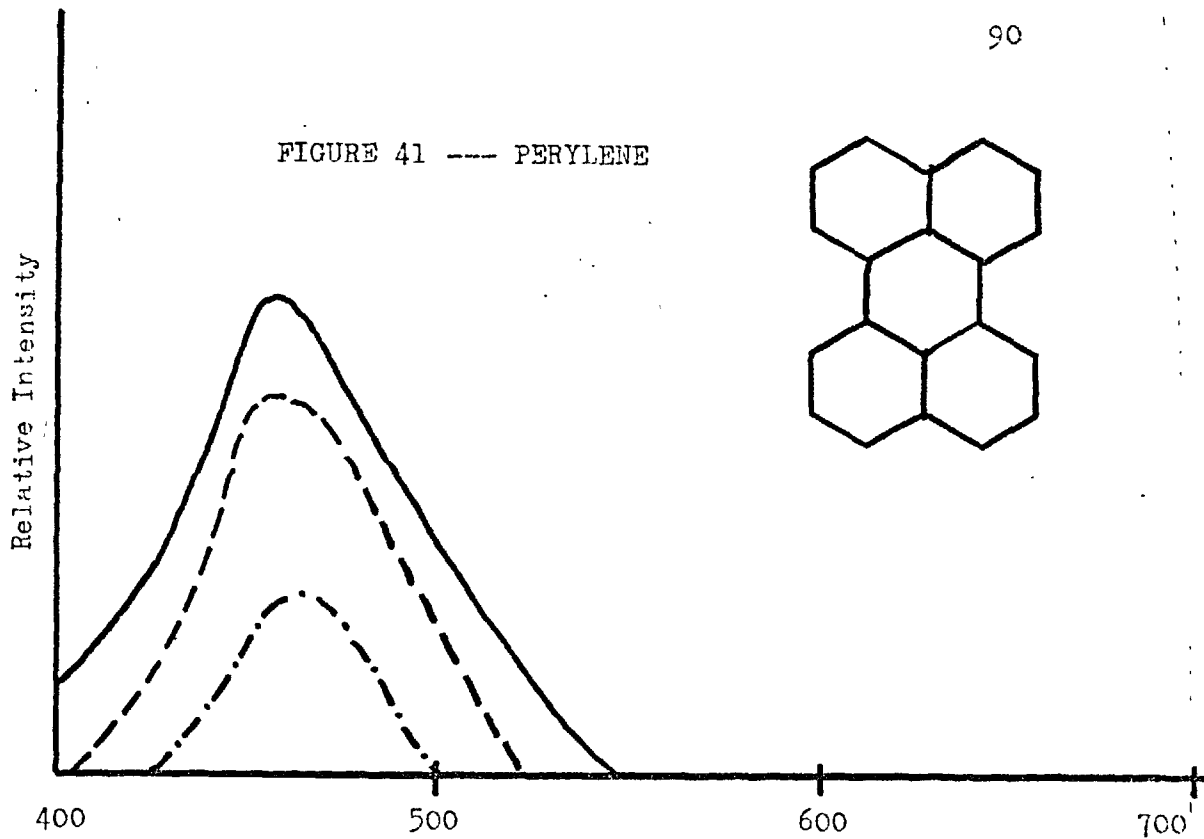

FIGURE 42 - CHRYSENE

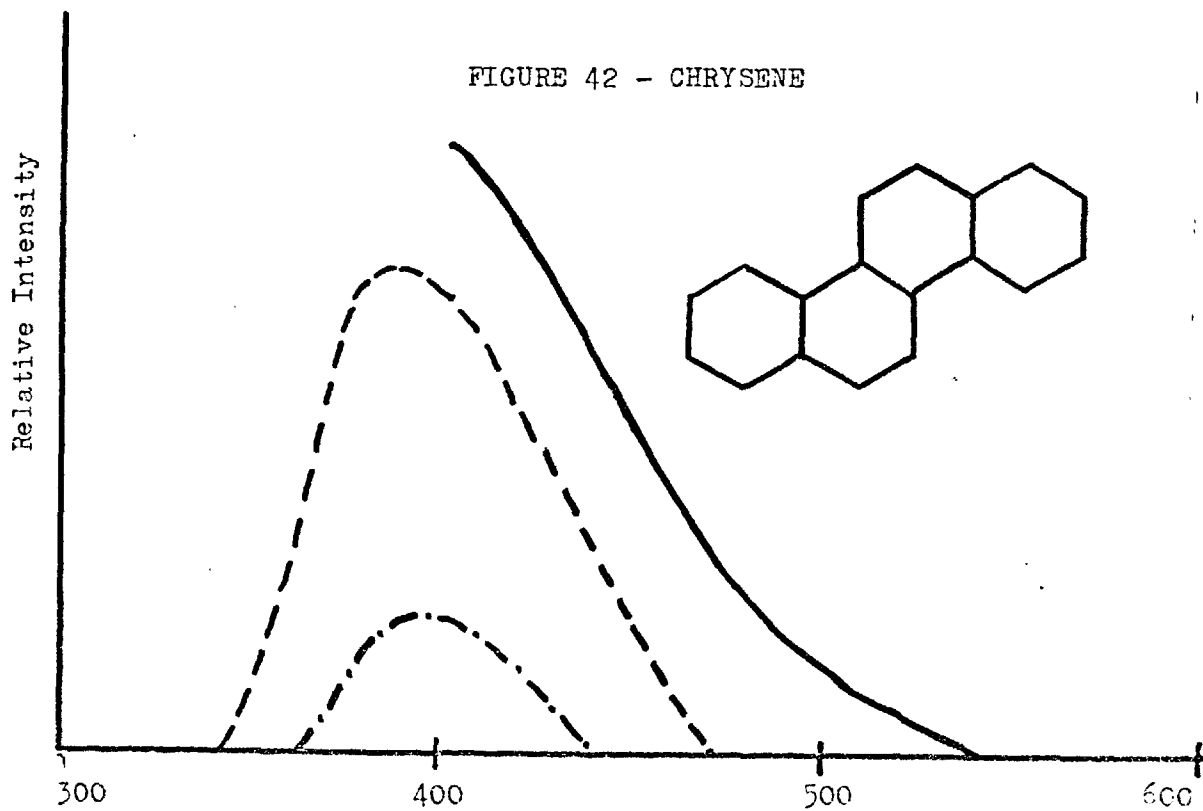

FIGURE 43 - PYRENE

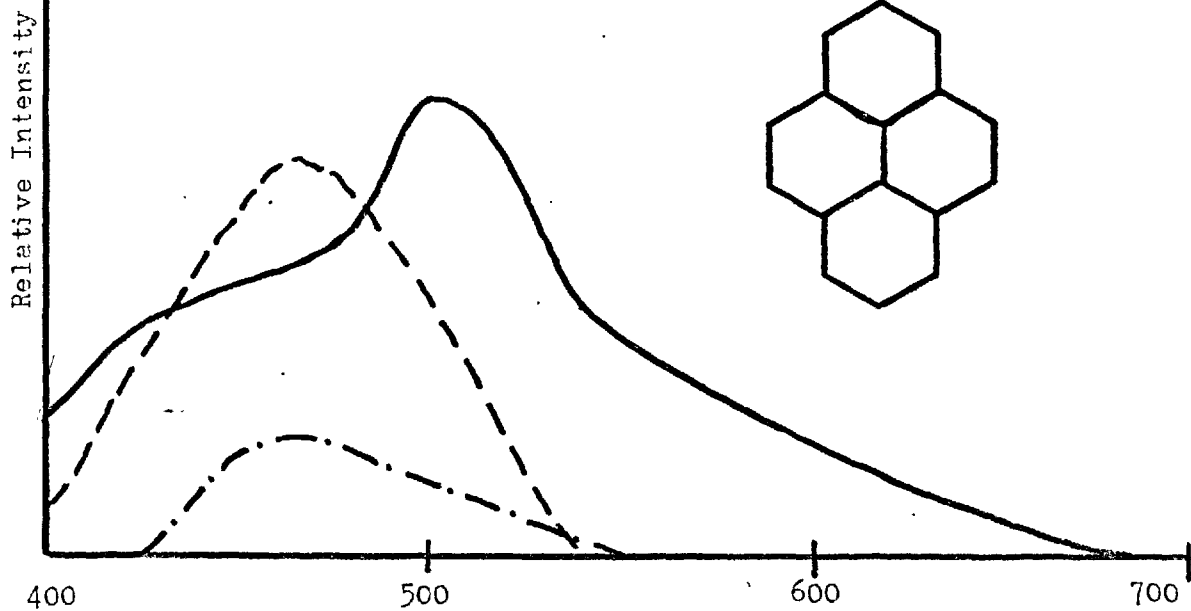
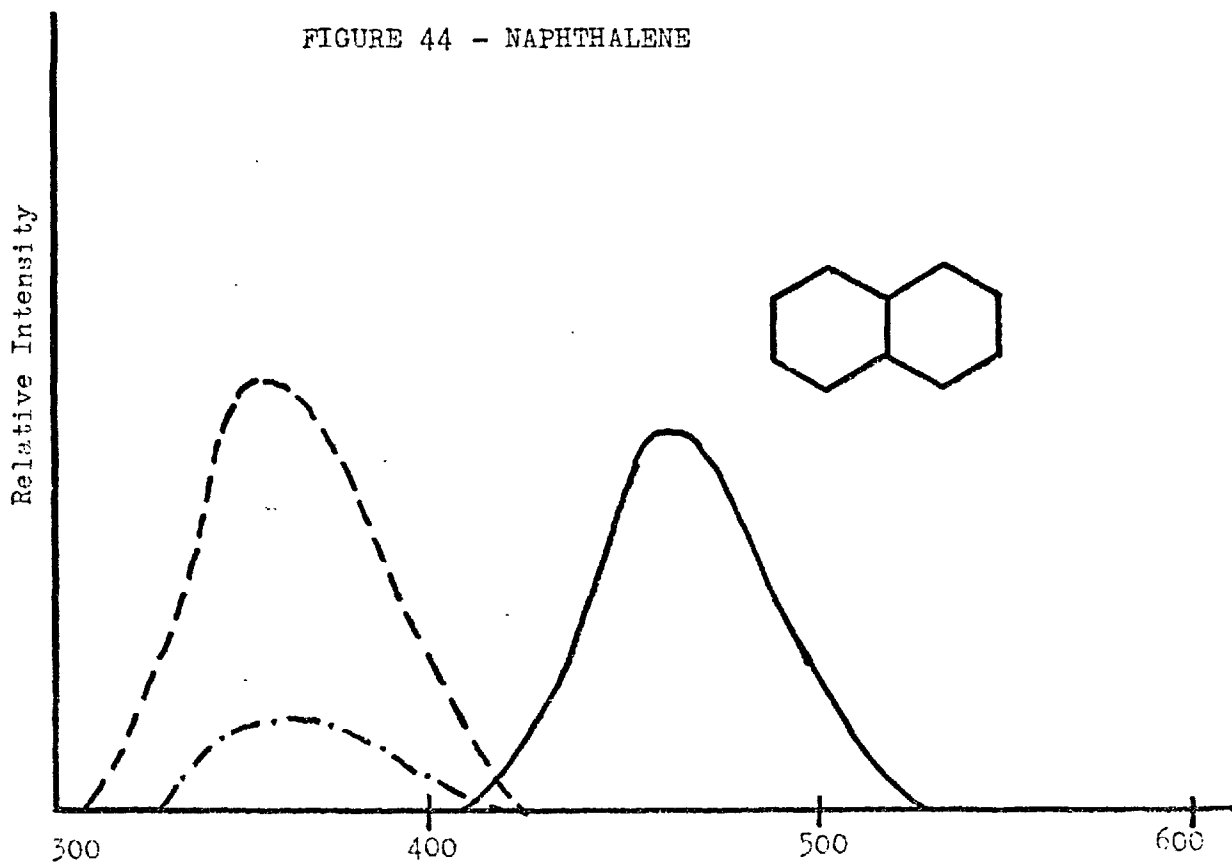

FIGURE 44 - NAPHTHALENE



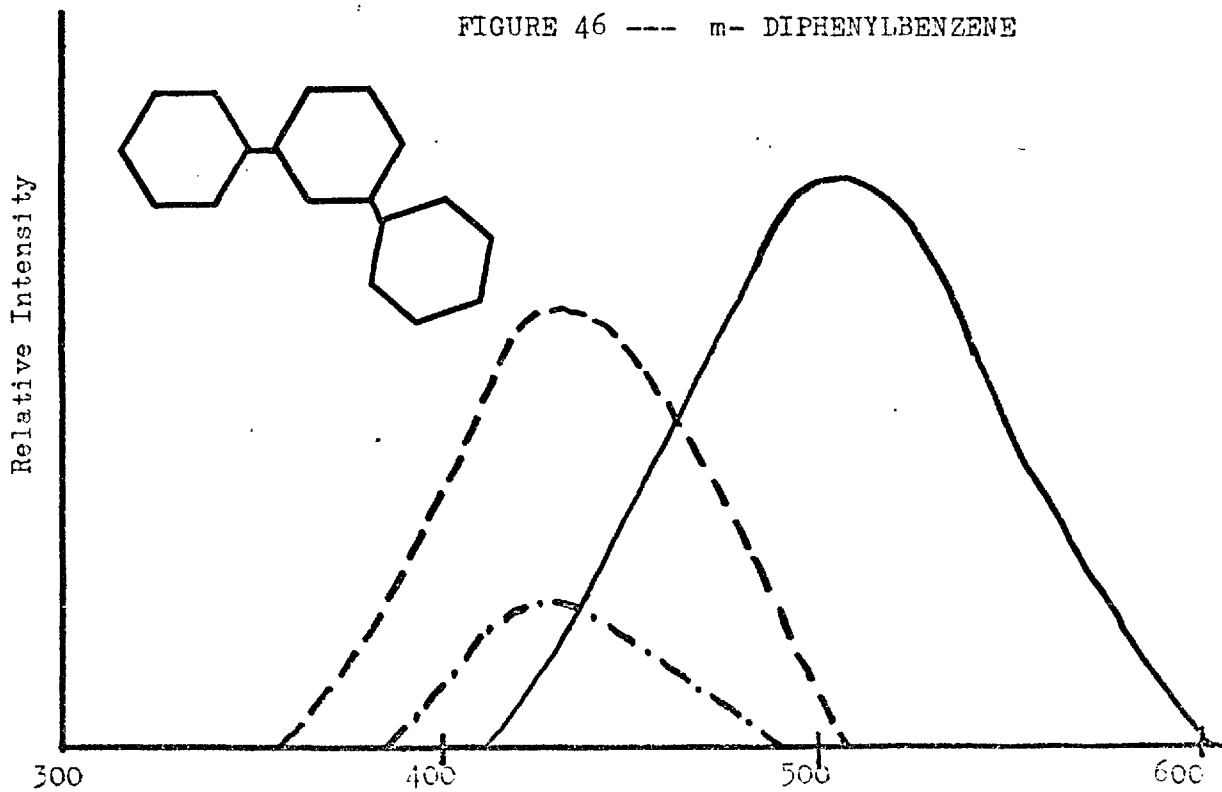
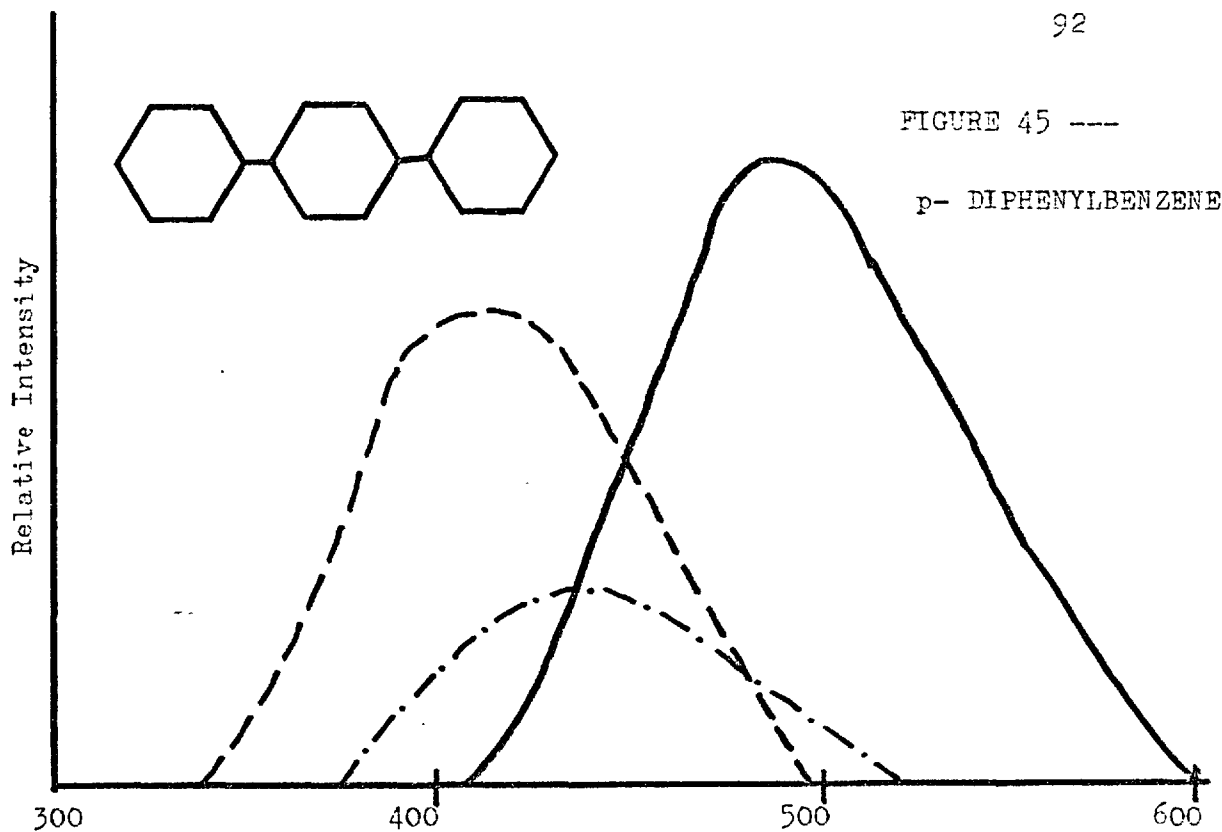

FIGURE 47 --- o- DIPHENYLBENZENE

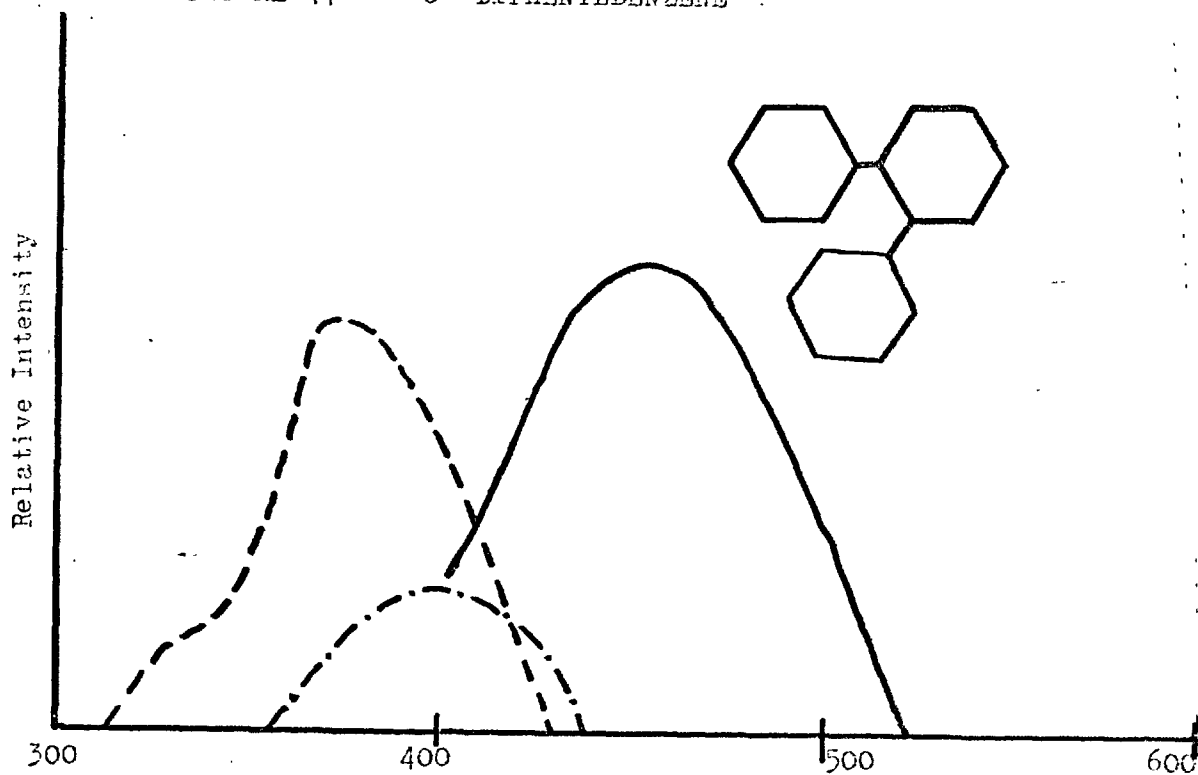

FIGURE 48 --- m- QUINQUEPHENYL

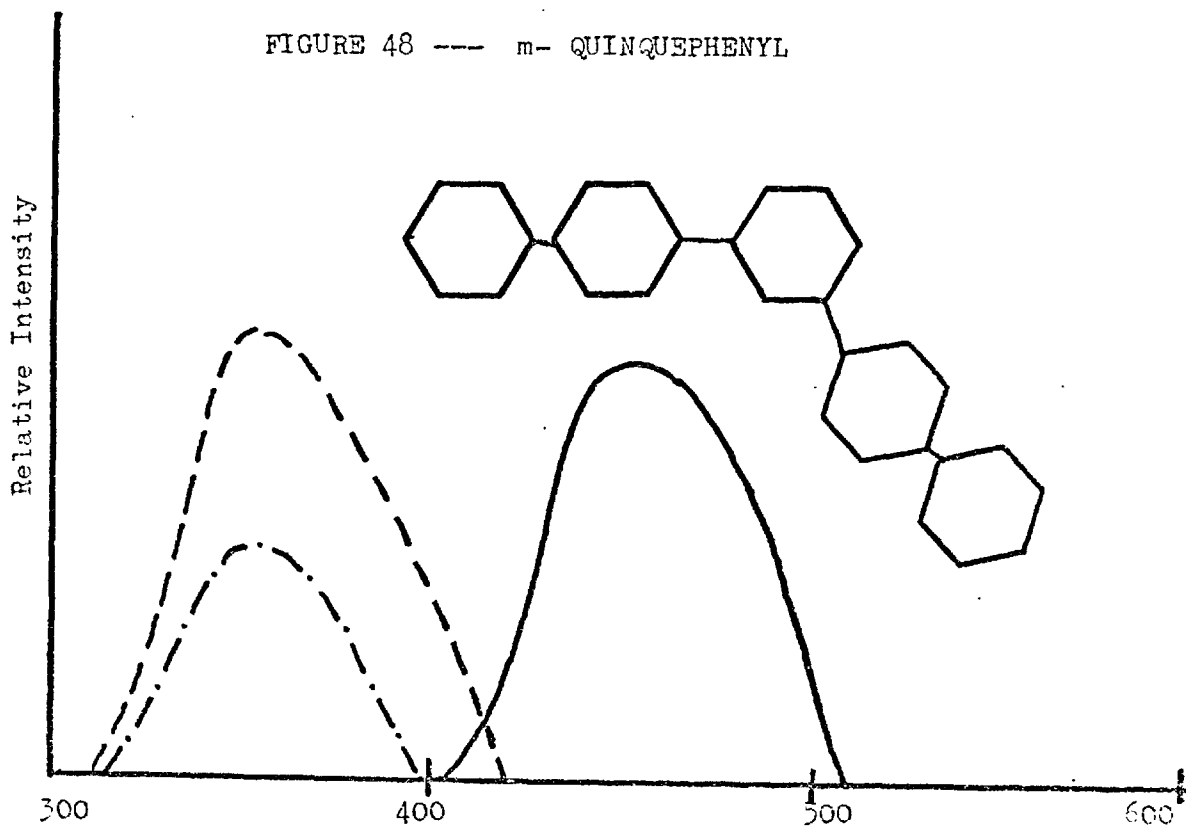

FIGURE 49 --- p- QUINQUEPHENYL

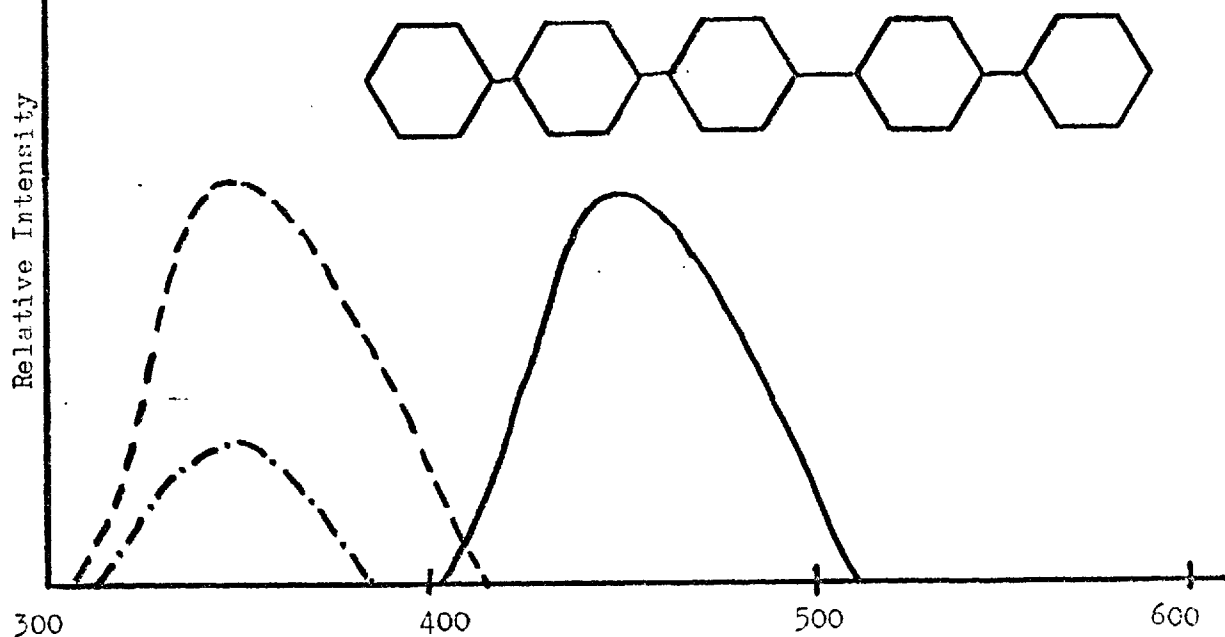
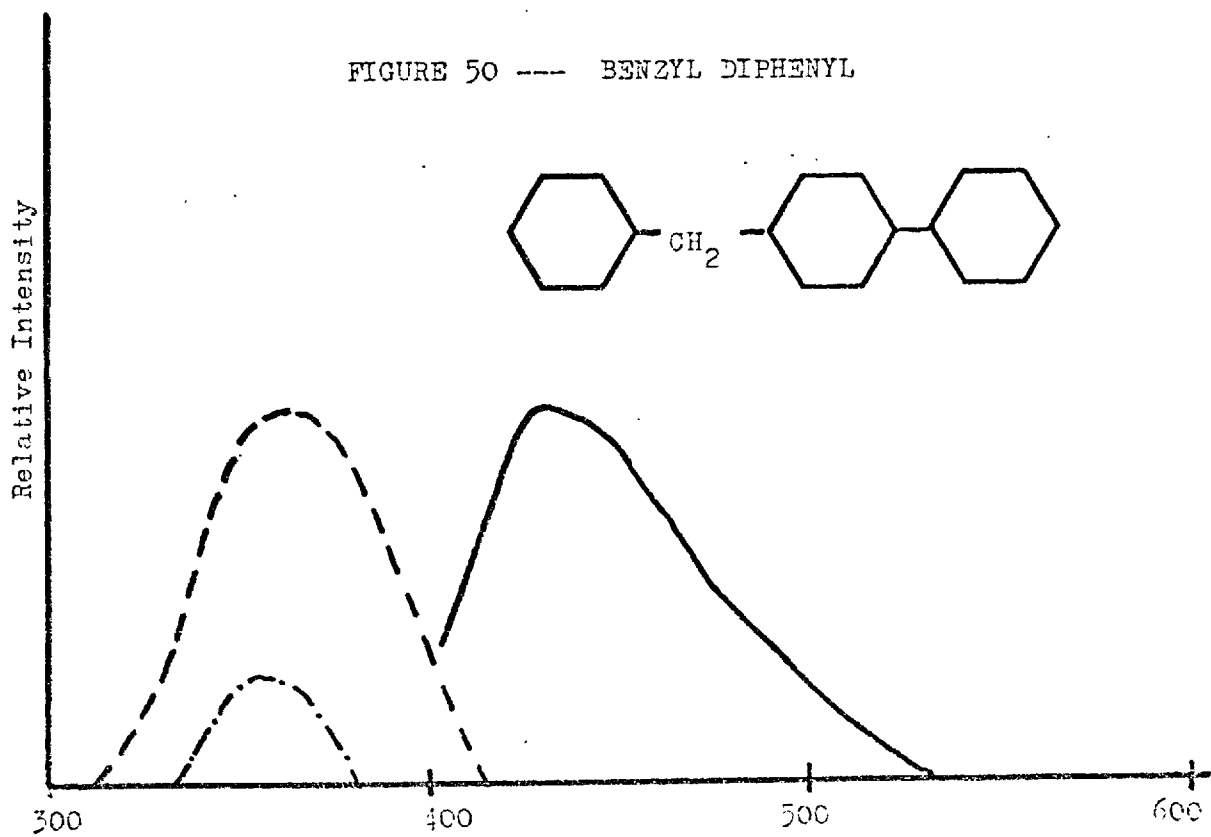

FIGURE 50 --- BENZYL DIPHENYL



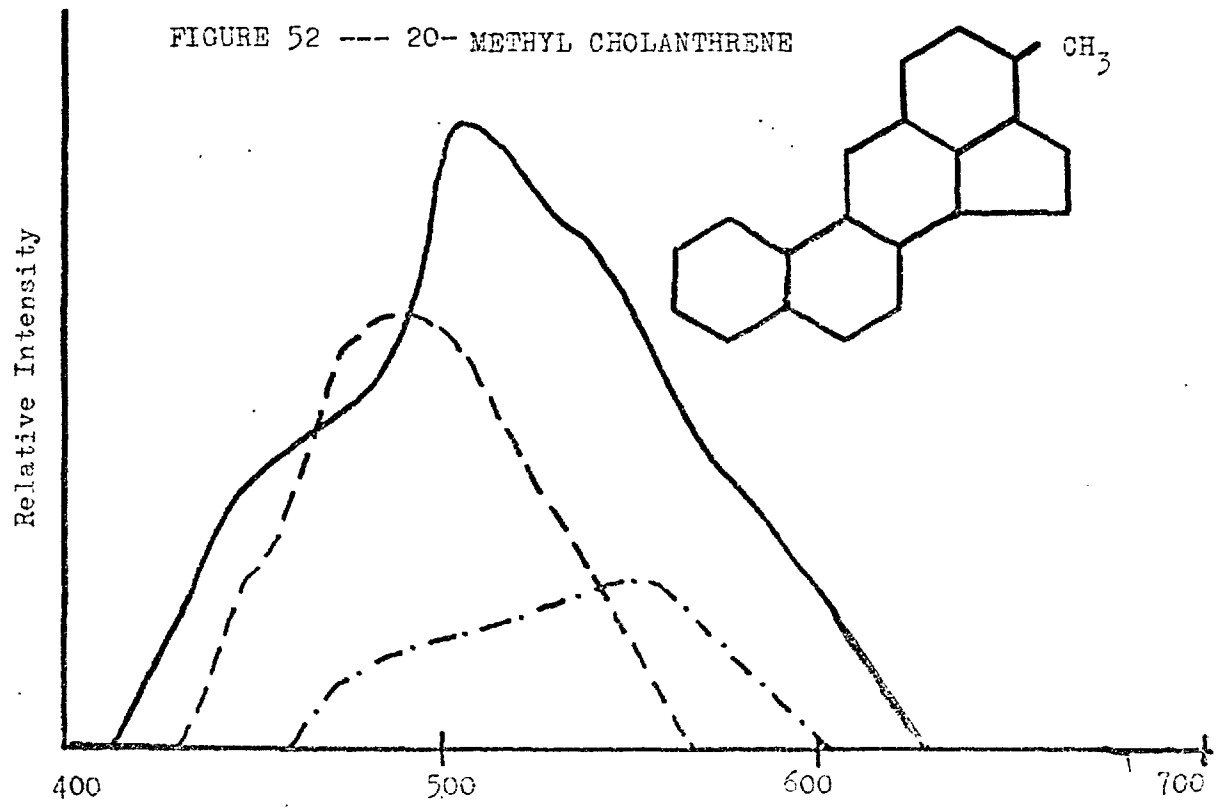
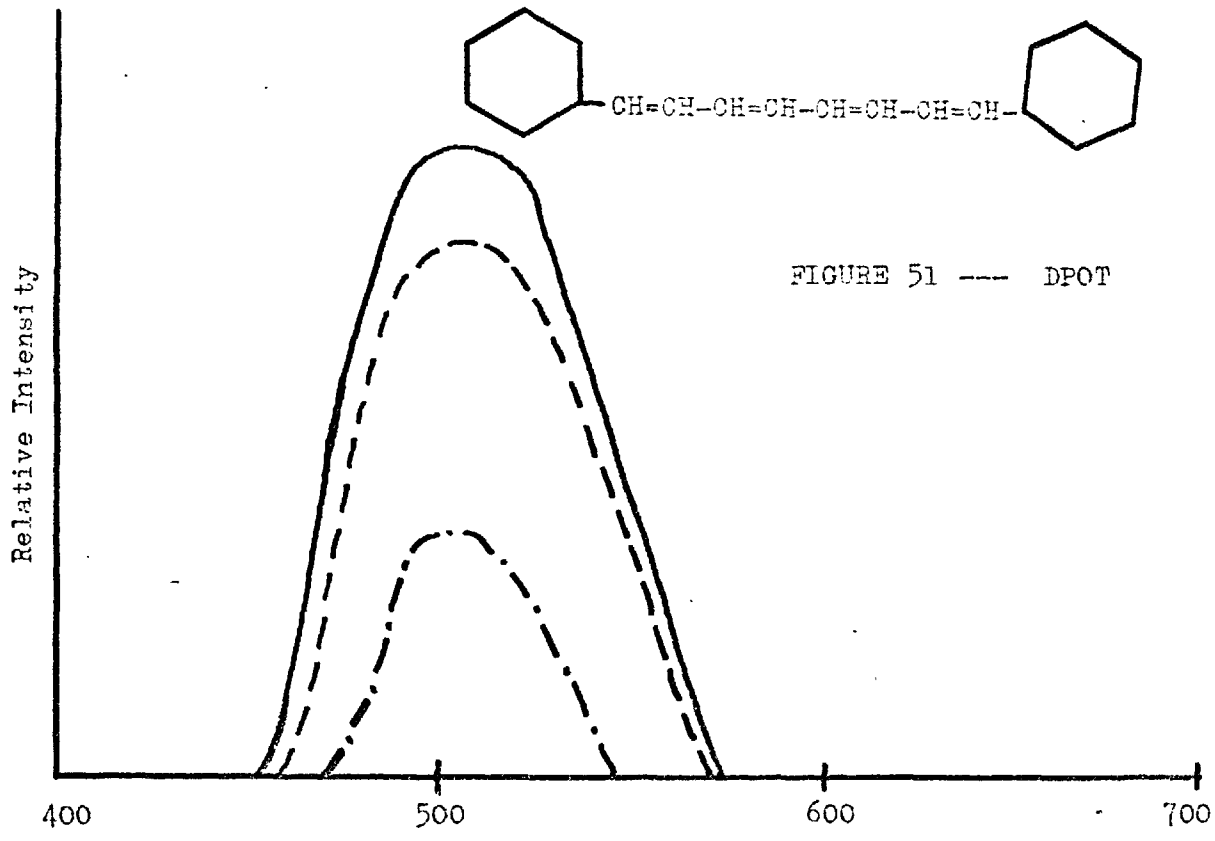

FIGURE 53 --- FLUORANTHENE

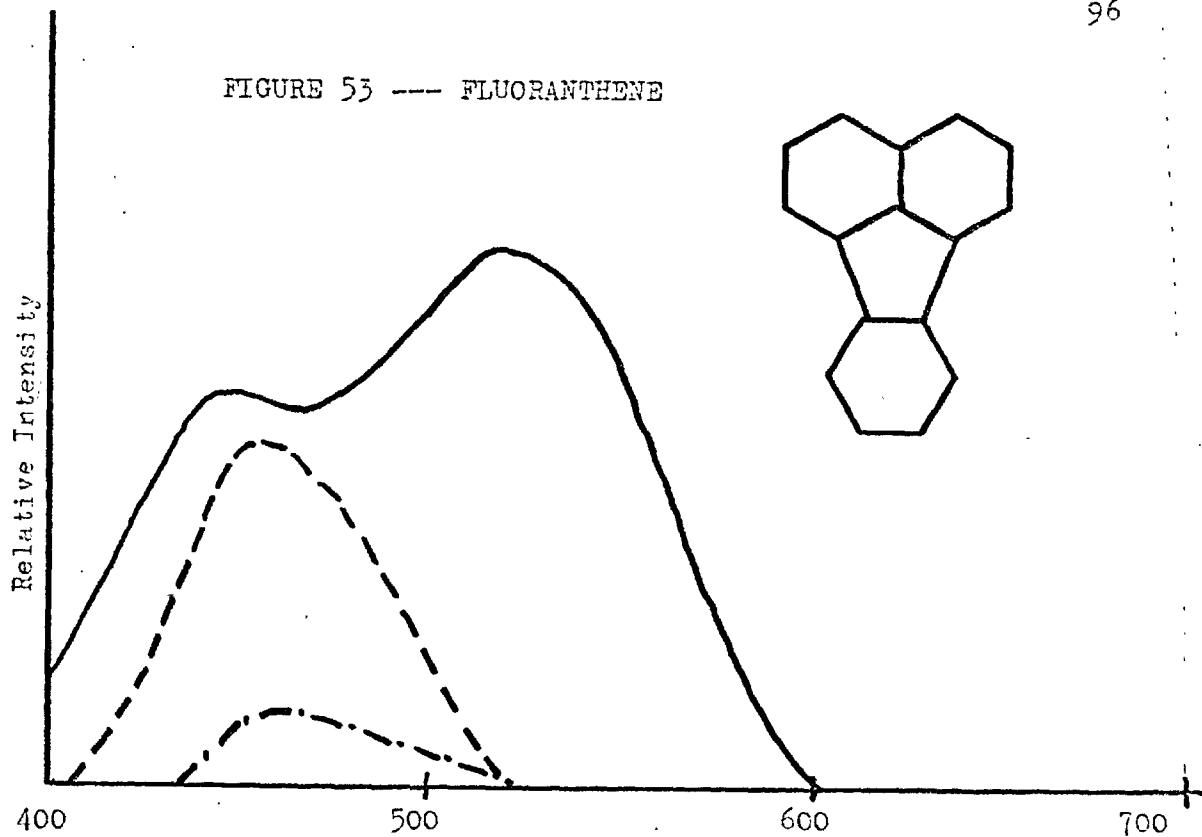

FIGURE 54 --- PICENE

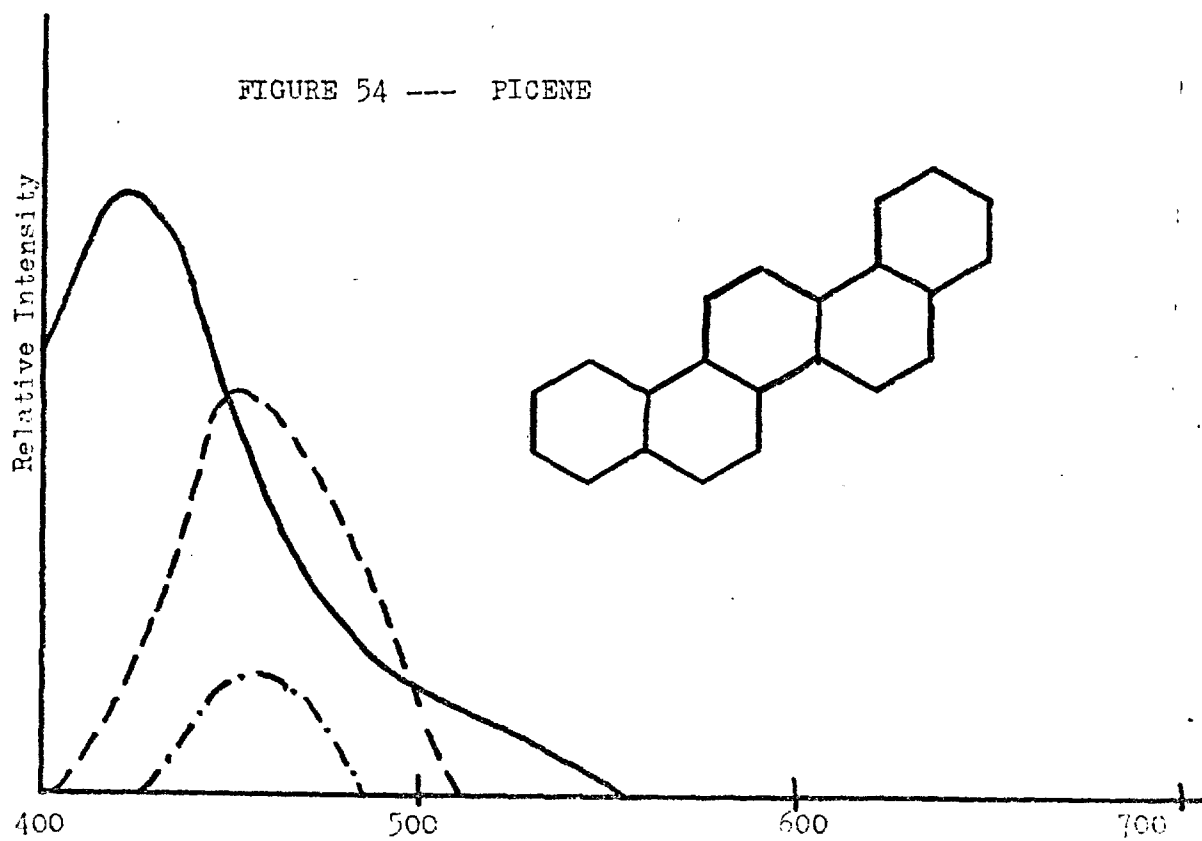

FIGURE 55 --- TRIPHENYLENE

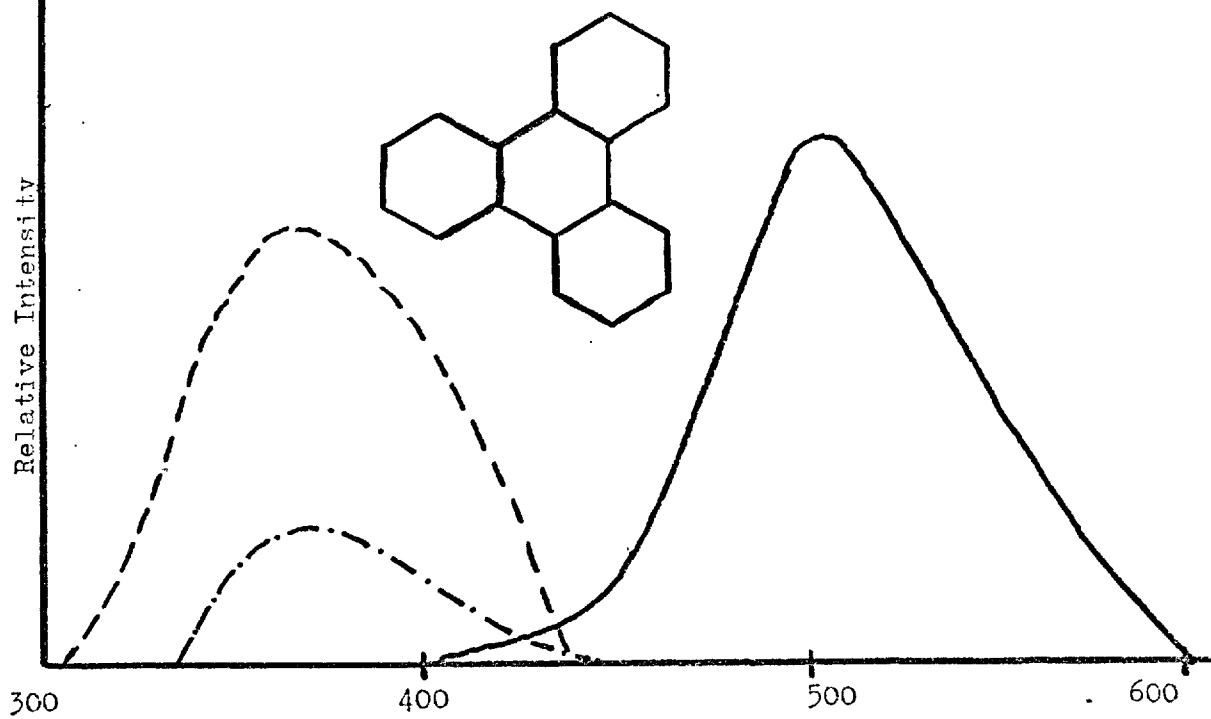

FIGURE 56 --- PHENANTHRENE

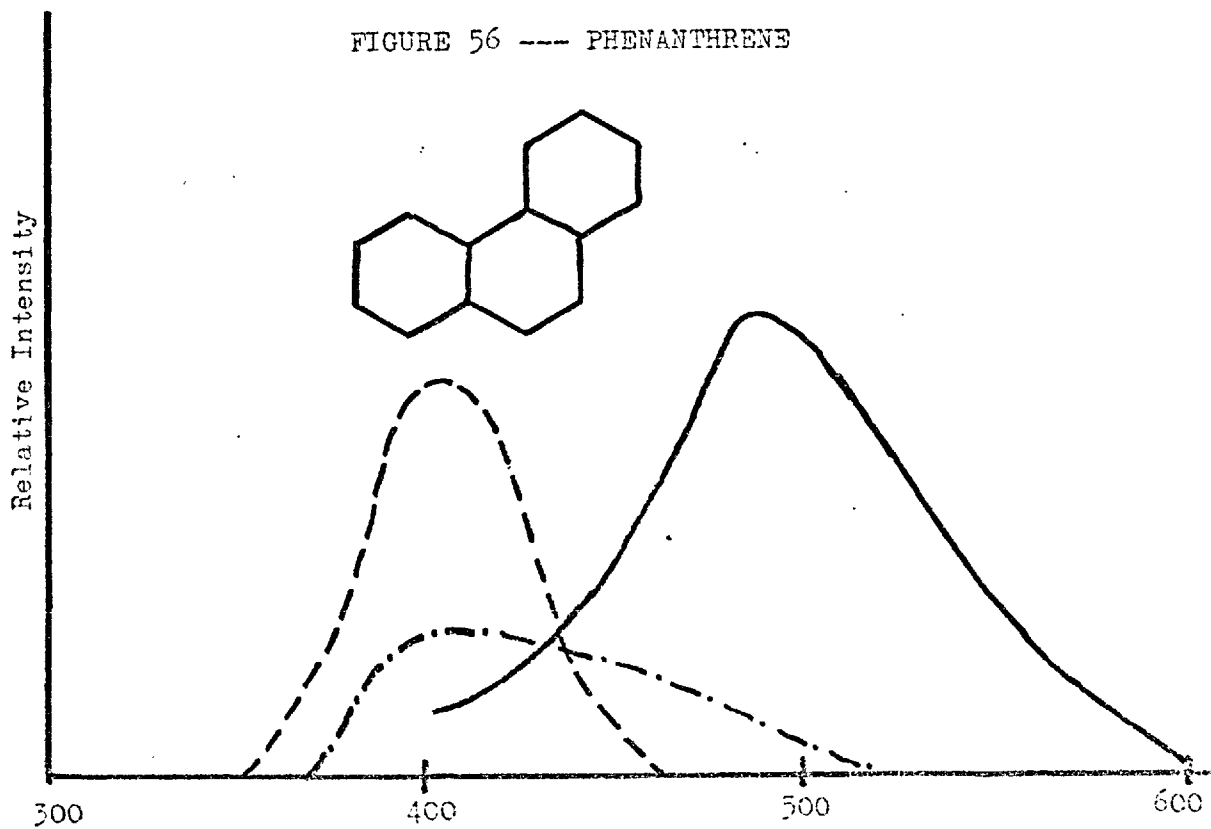

FIGURE 57 --- BENZO (g,h,i,) FLUORANTHENE

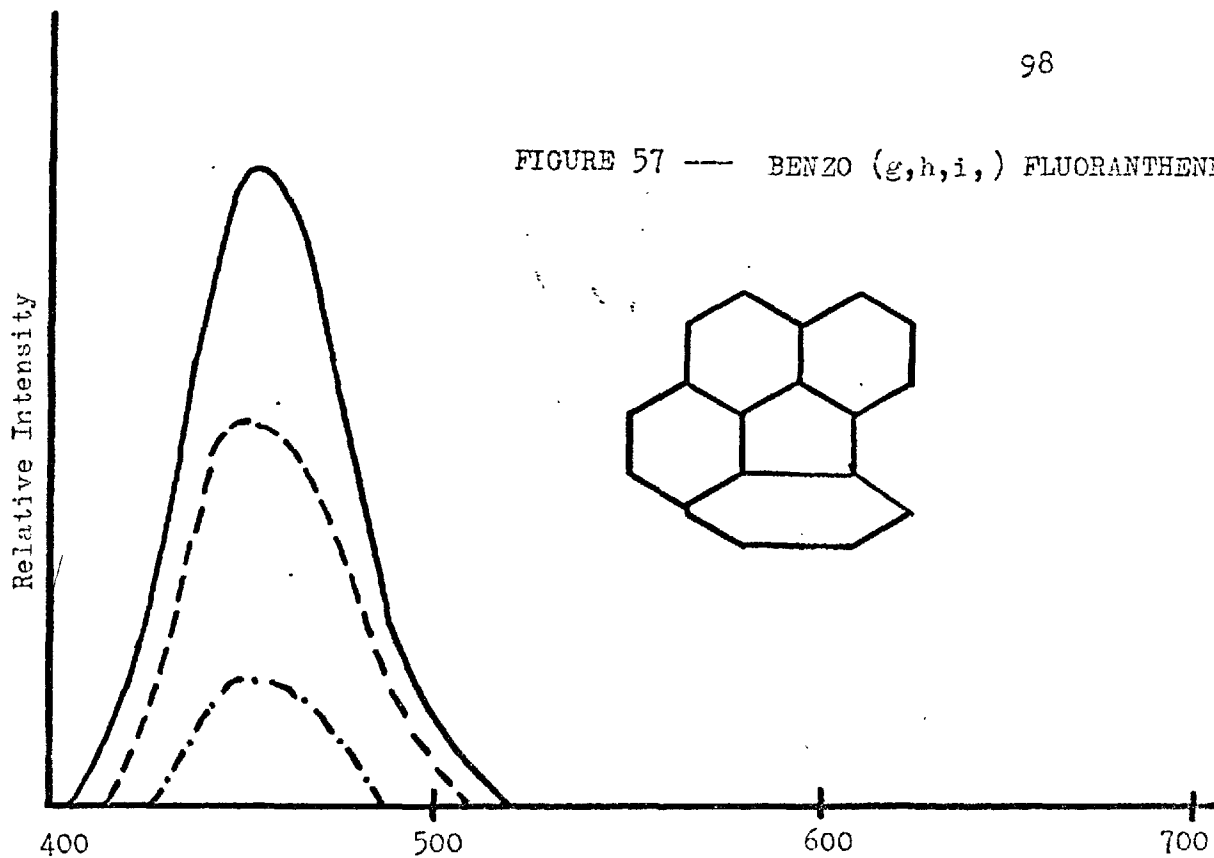

FIGURE 58 --- BENZO (b) FLUORANTHENE

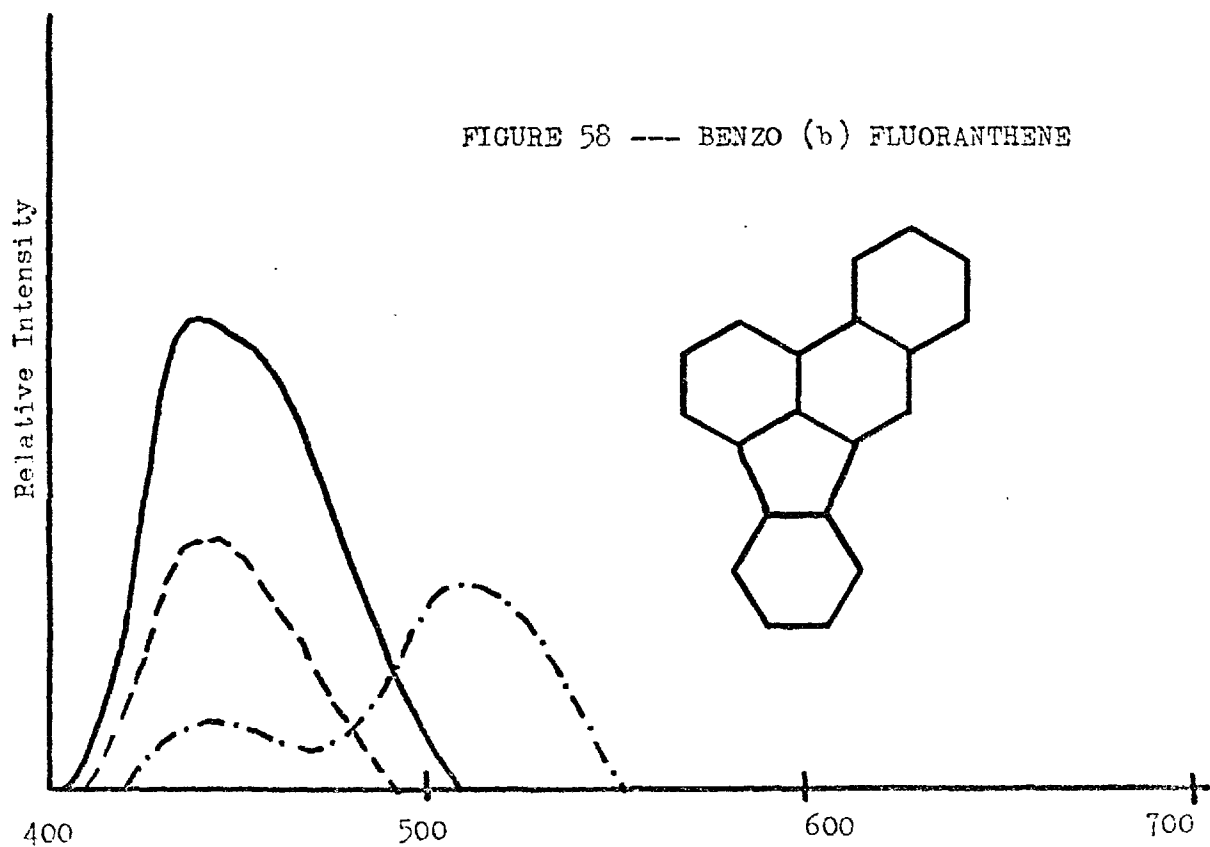

FIGURE 59 --- 9- BROMOANTHRACENE

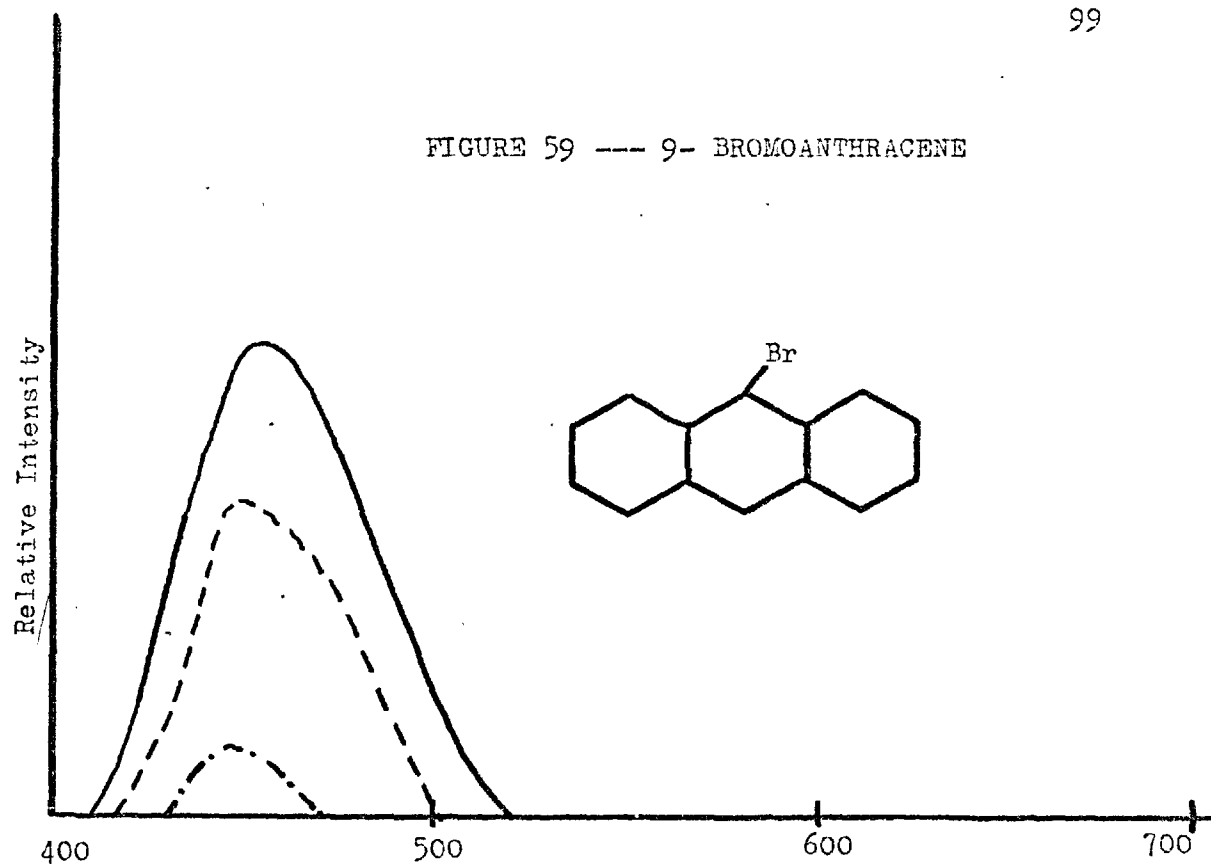

FIGURE 60 --- ANTHANTHRENE

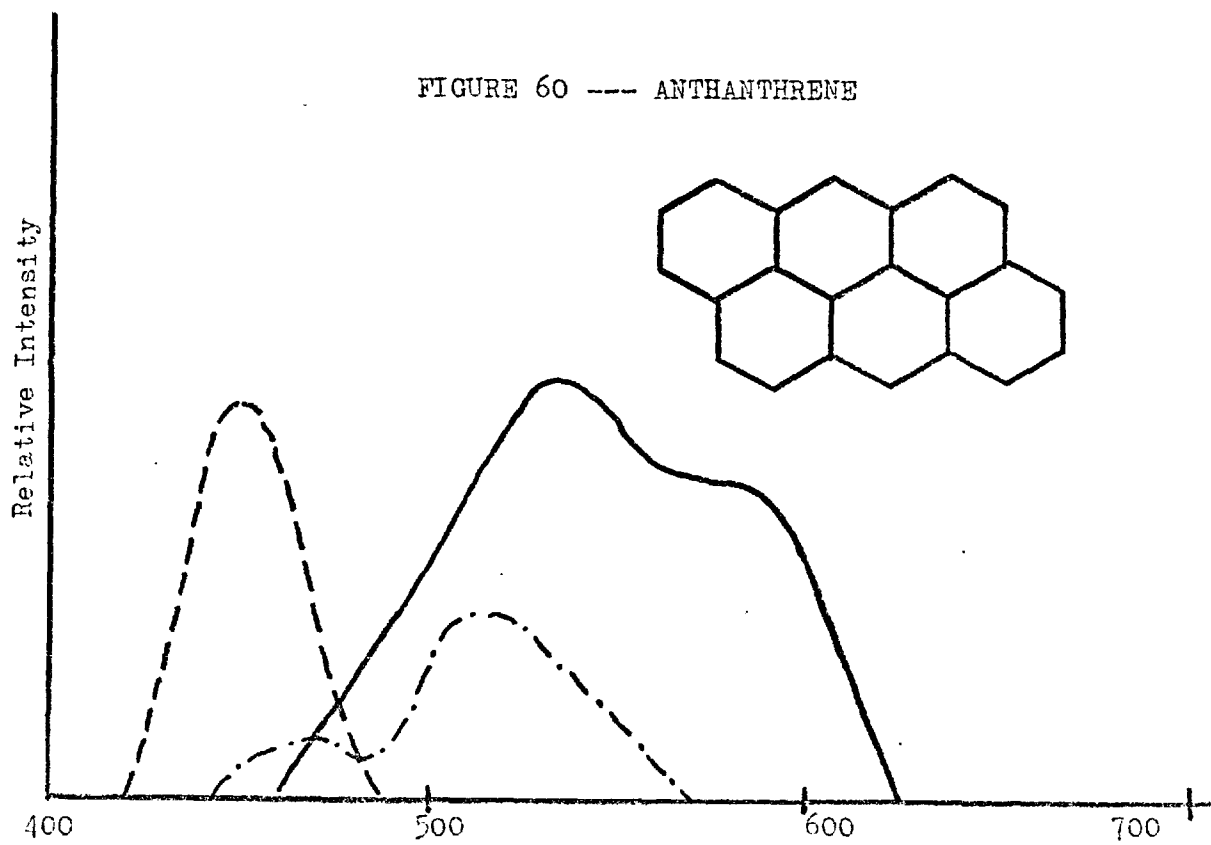

FIGURE 61 - 2- PHENYLNAPHTHALENE

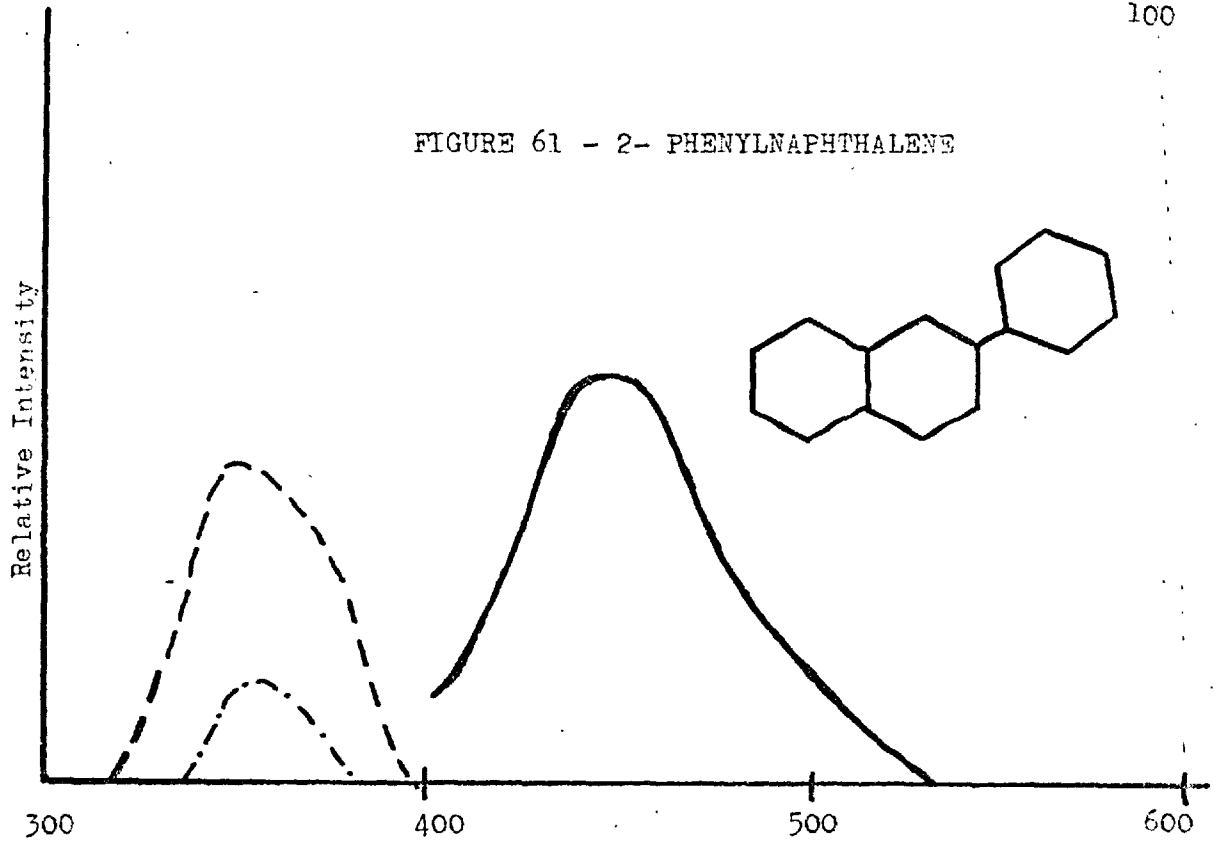

FIGURE 62 --- BENZO (g,h,i) PERYLENE

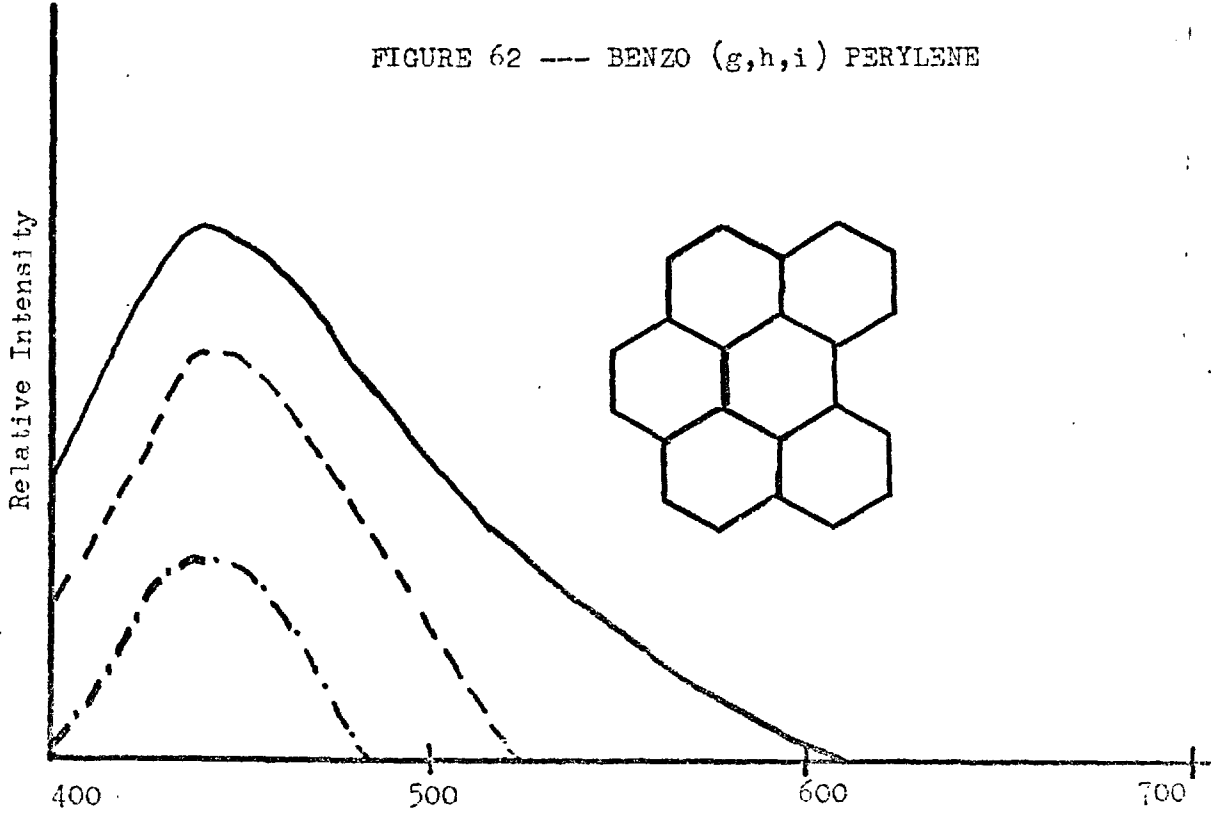

FIGURE 63 --- CARBAZOLE

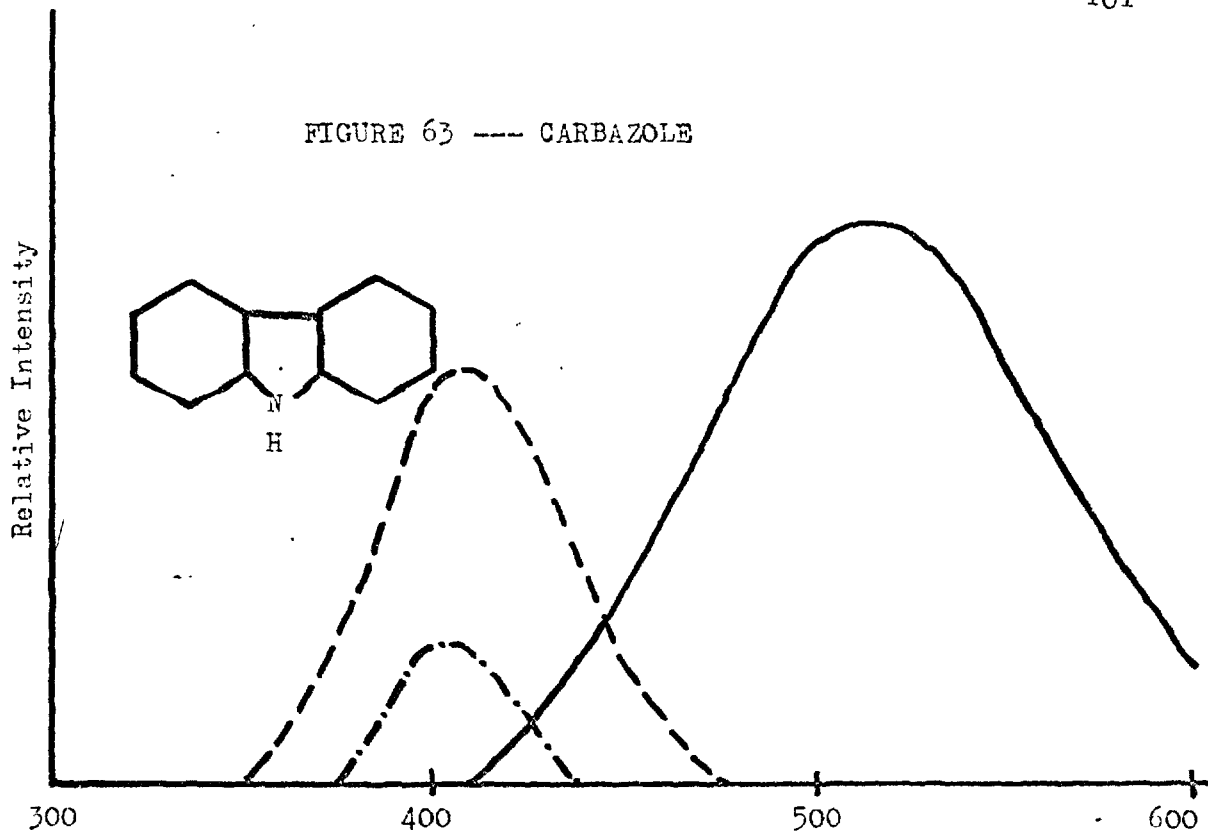
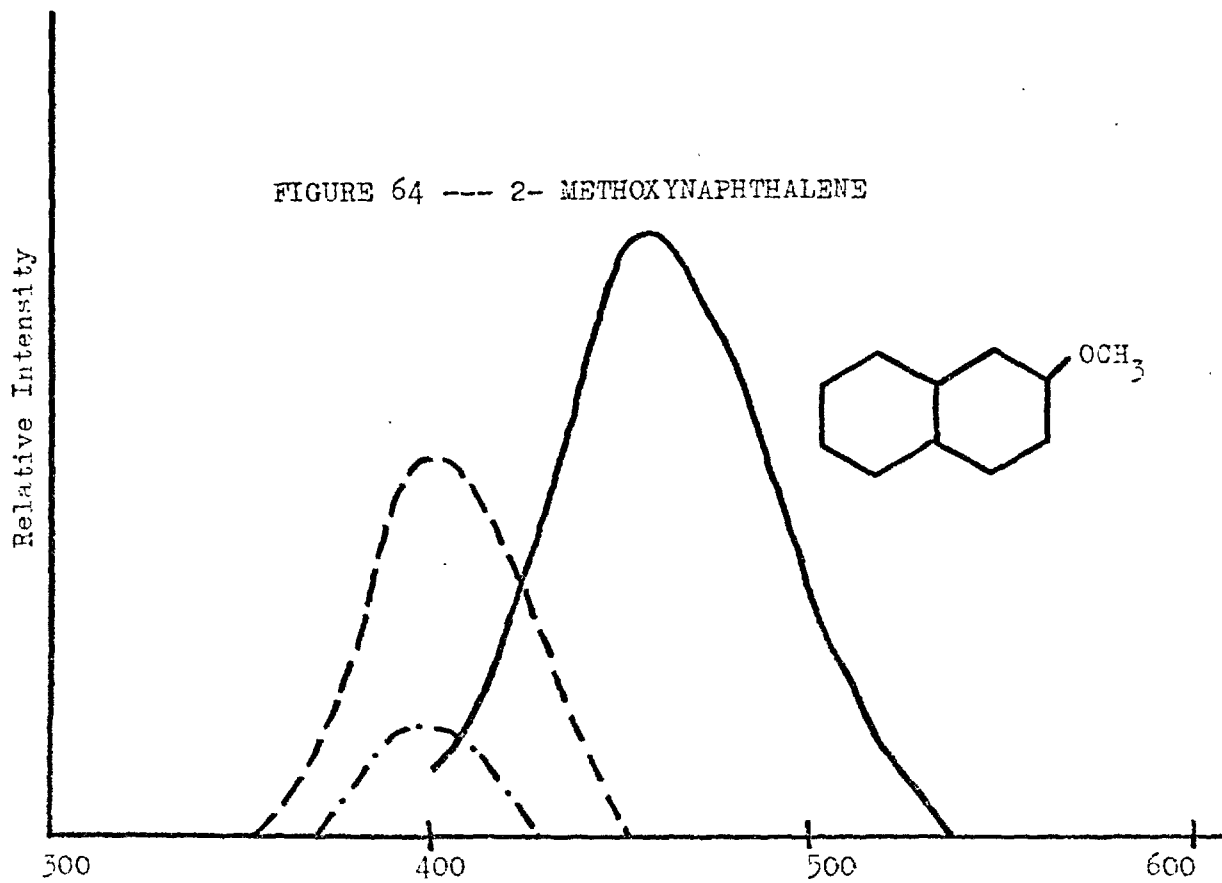

FIGURE 64 --- 2-METHOXYNAPHTHALENE



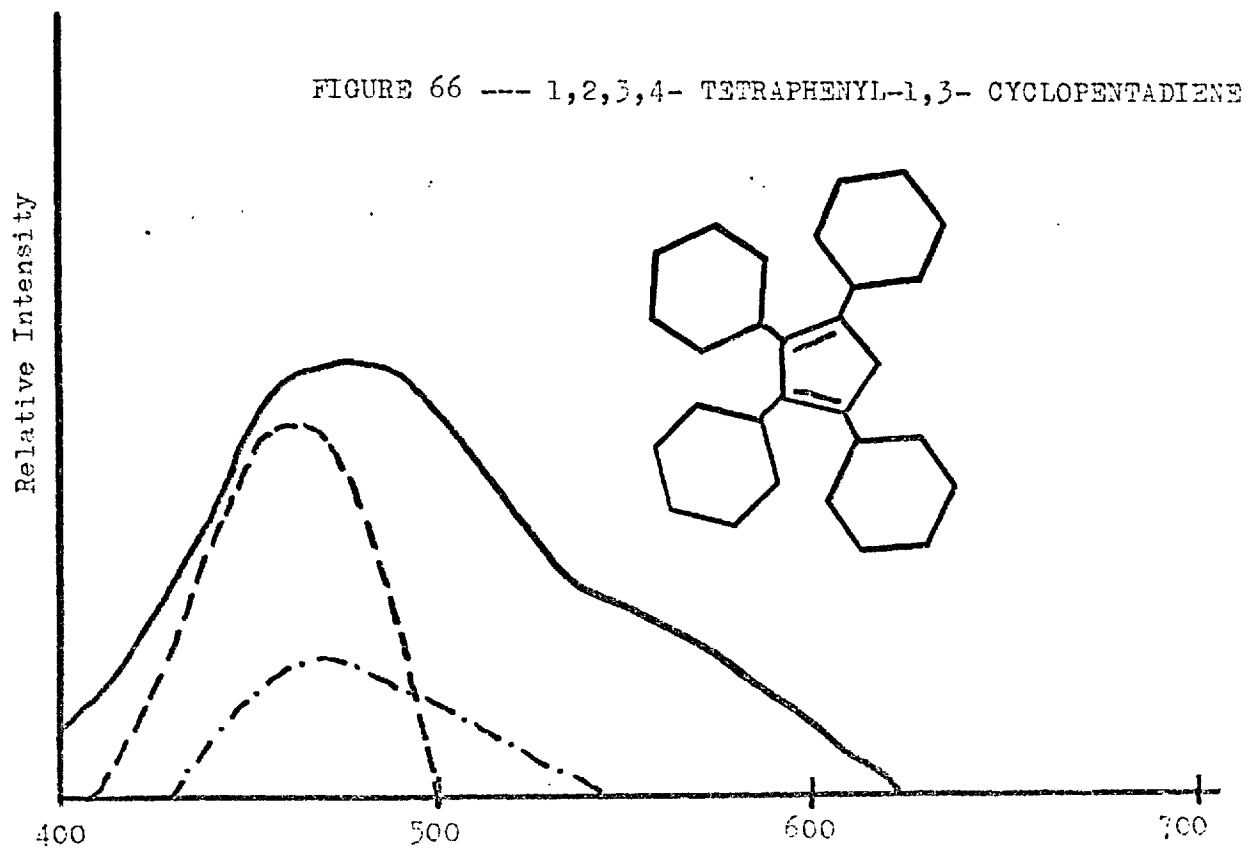
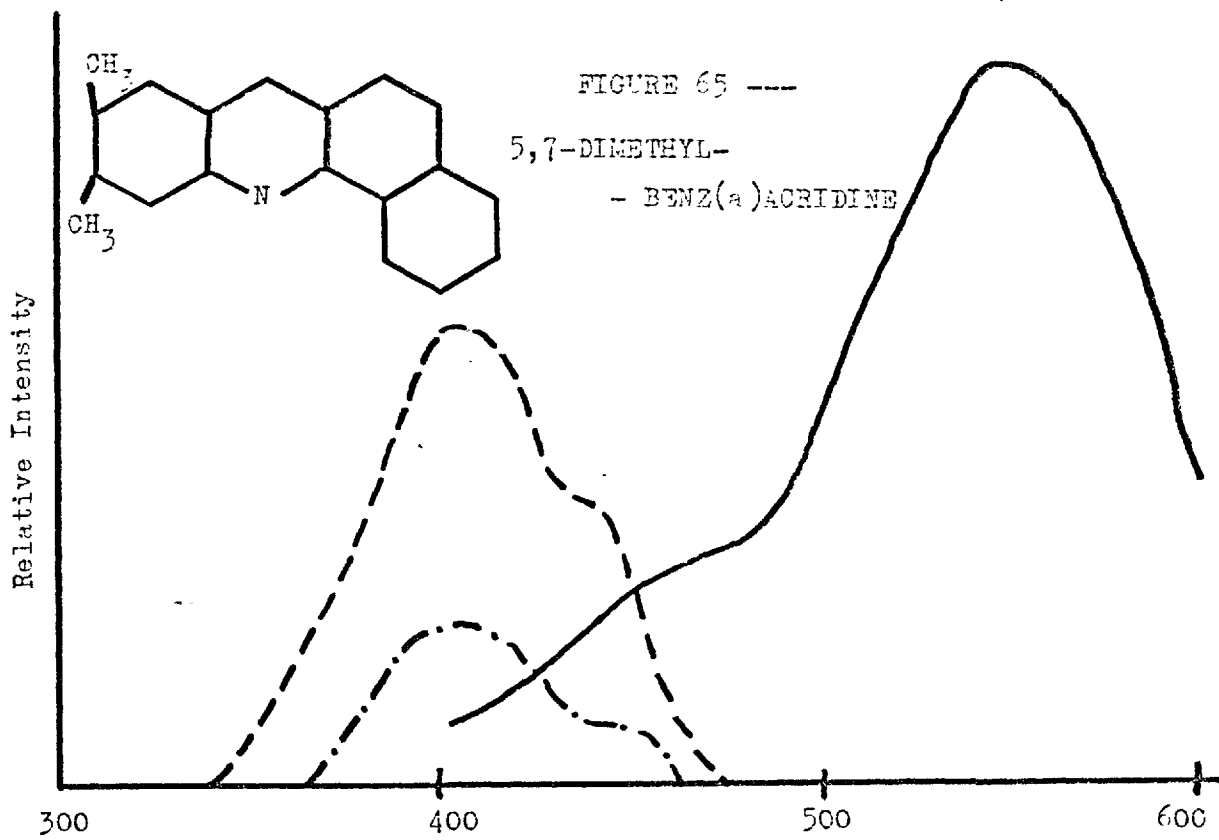

FIGURE 67 - PERIFLANTHENE

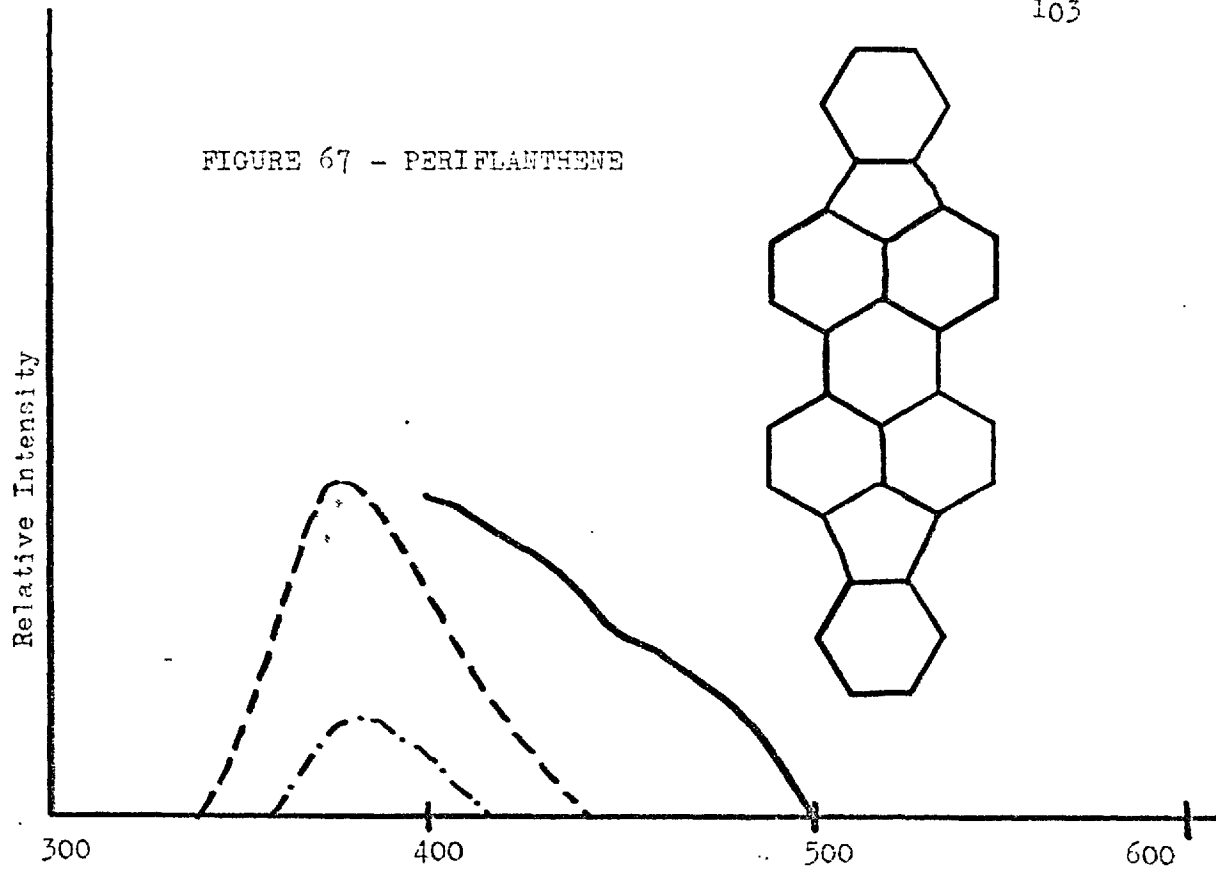

FIGURE 68 --- o- PHENYLENE PYRENE

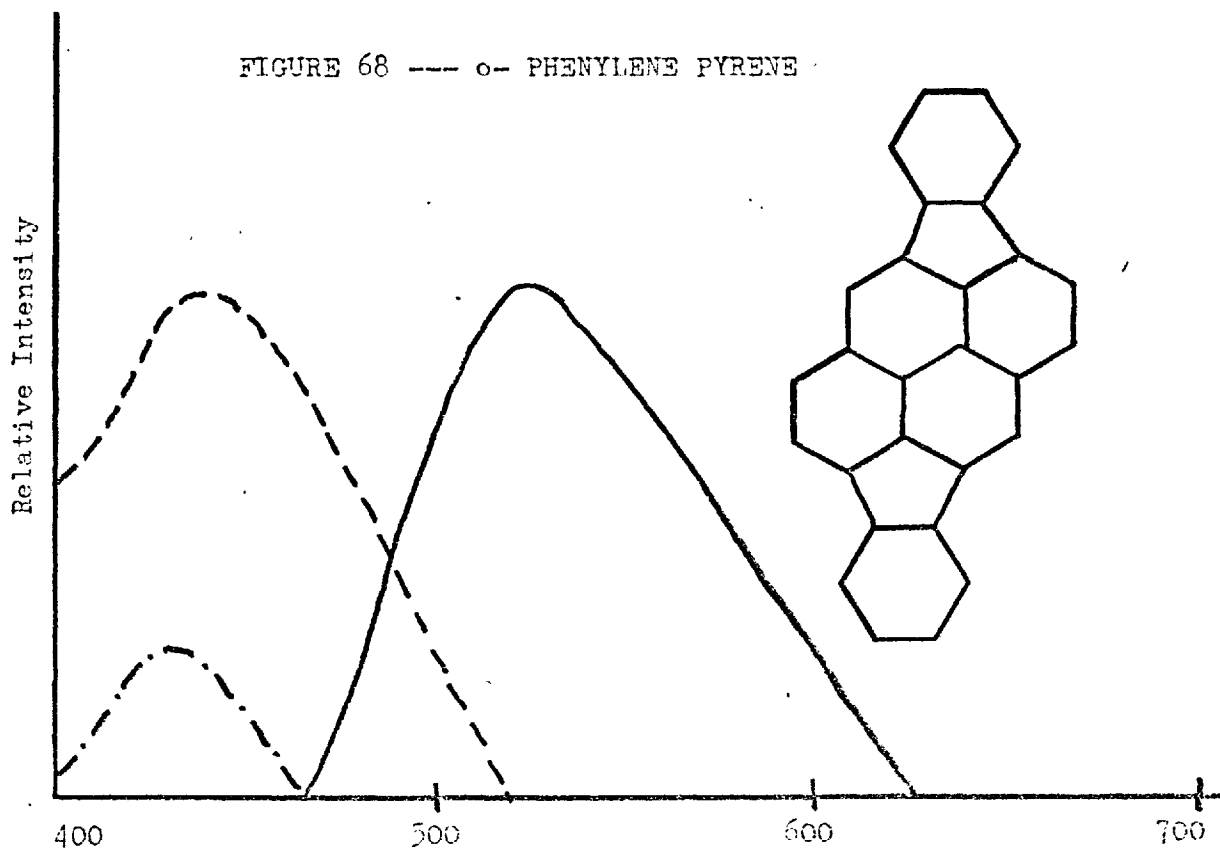

FIGURE 69 --- 1-METHYL PYRENE

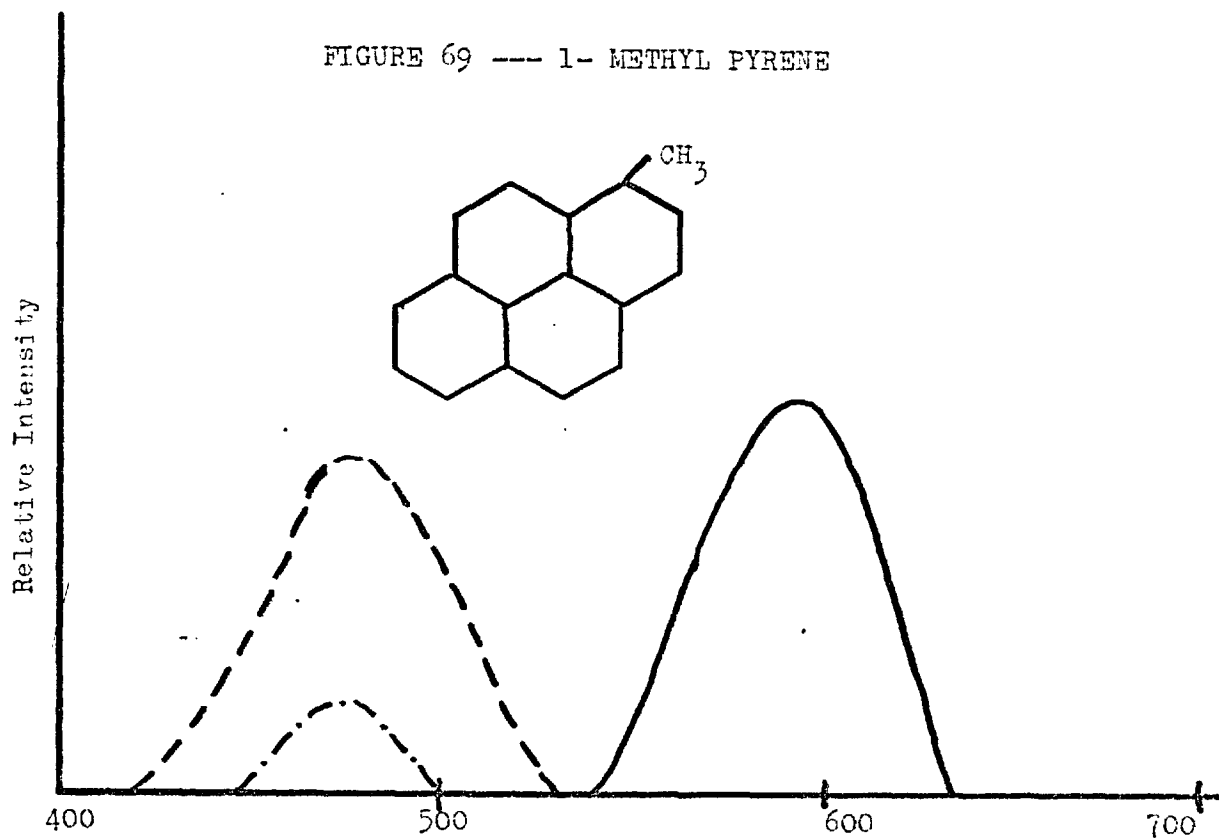

FIGURE 70 --- DIBENZO (a,c) ANTHRACENE

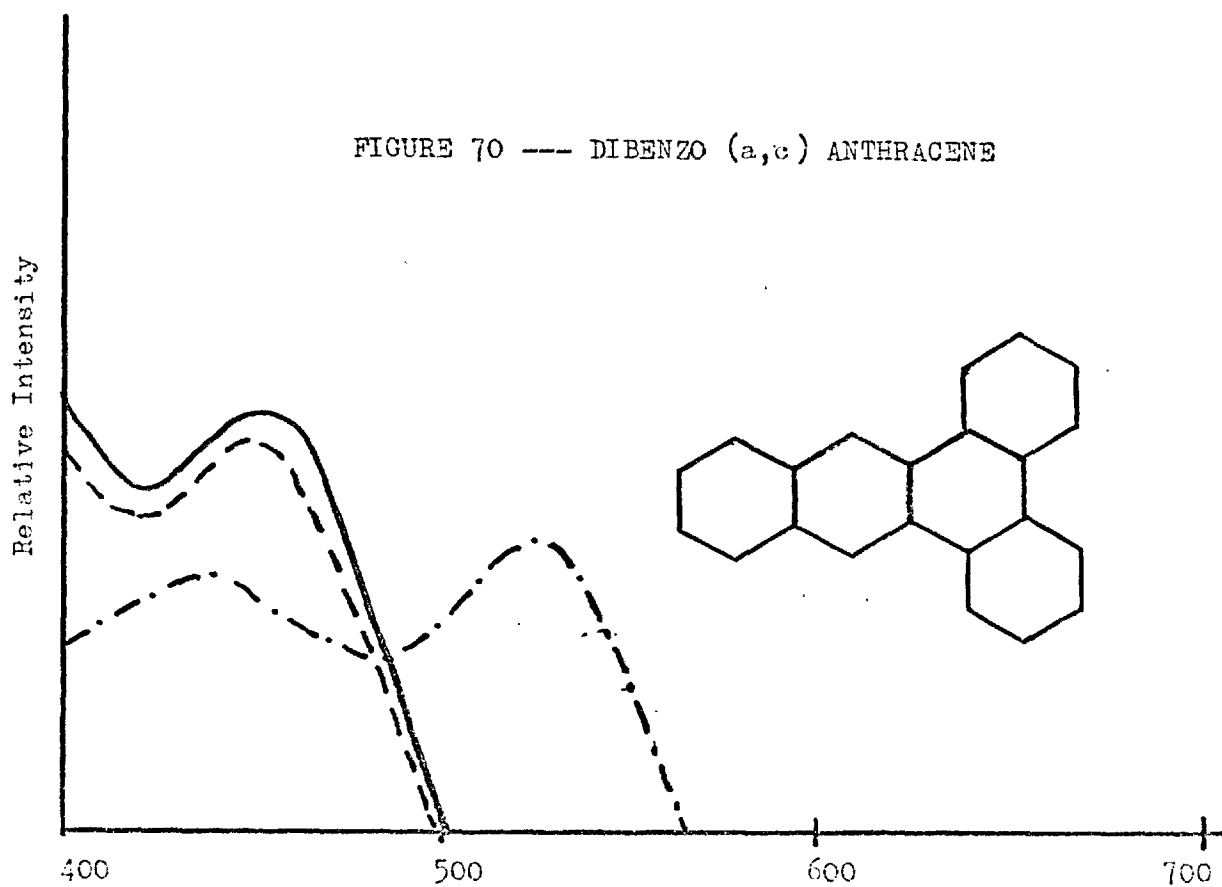

FIGURE 71 --- DIBENZ (a,h) ANTHRACENE

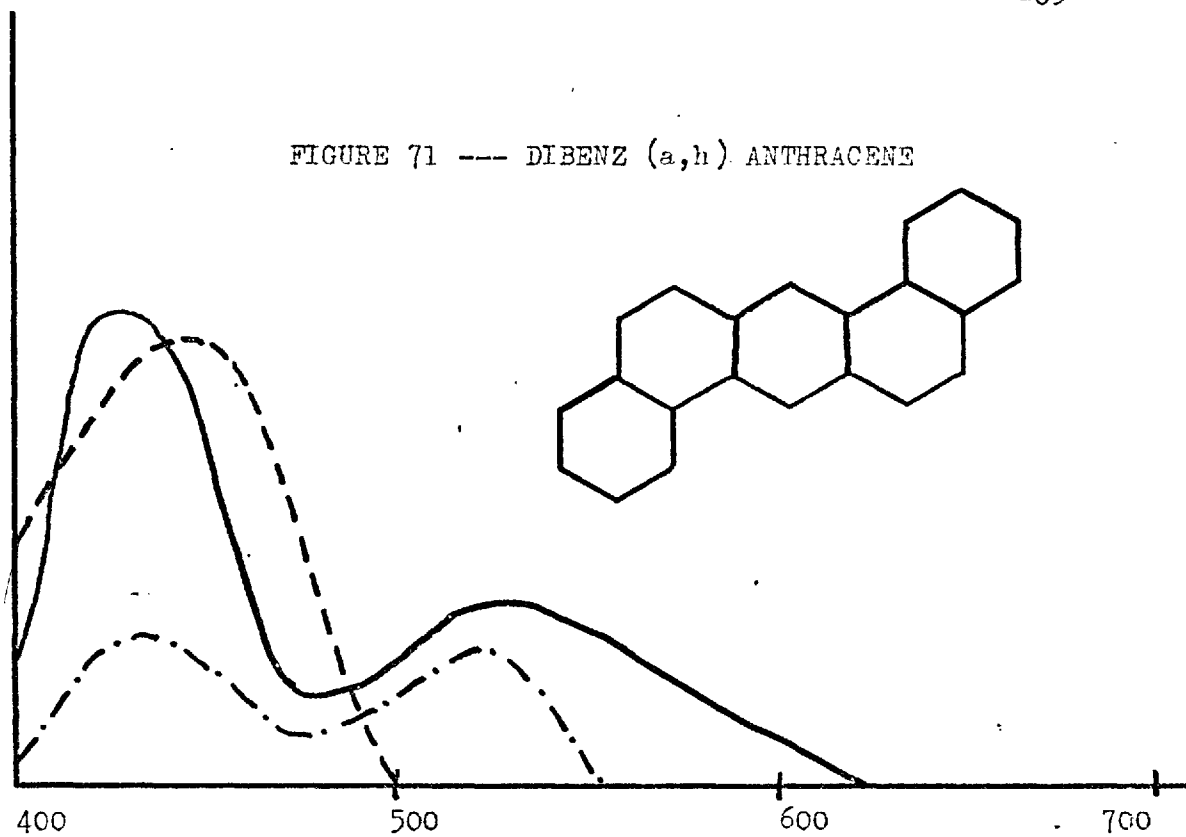

FIGURE 72 --- DIBENZ (a,j) ANTHRACENE

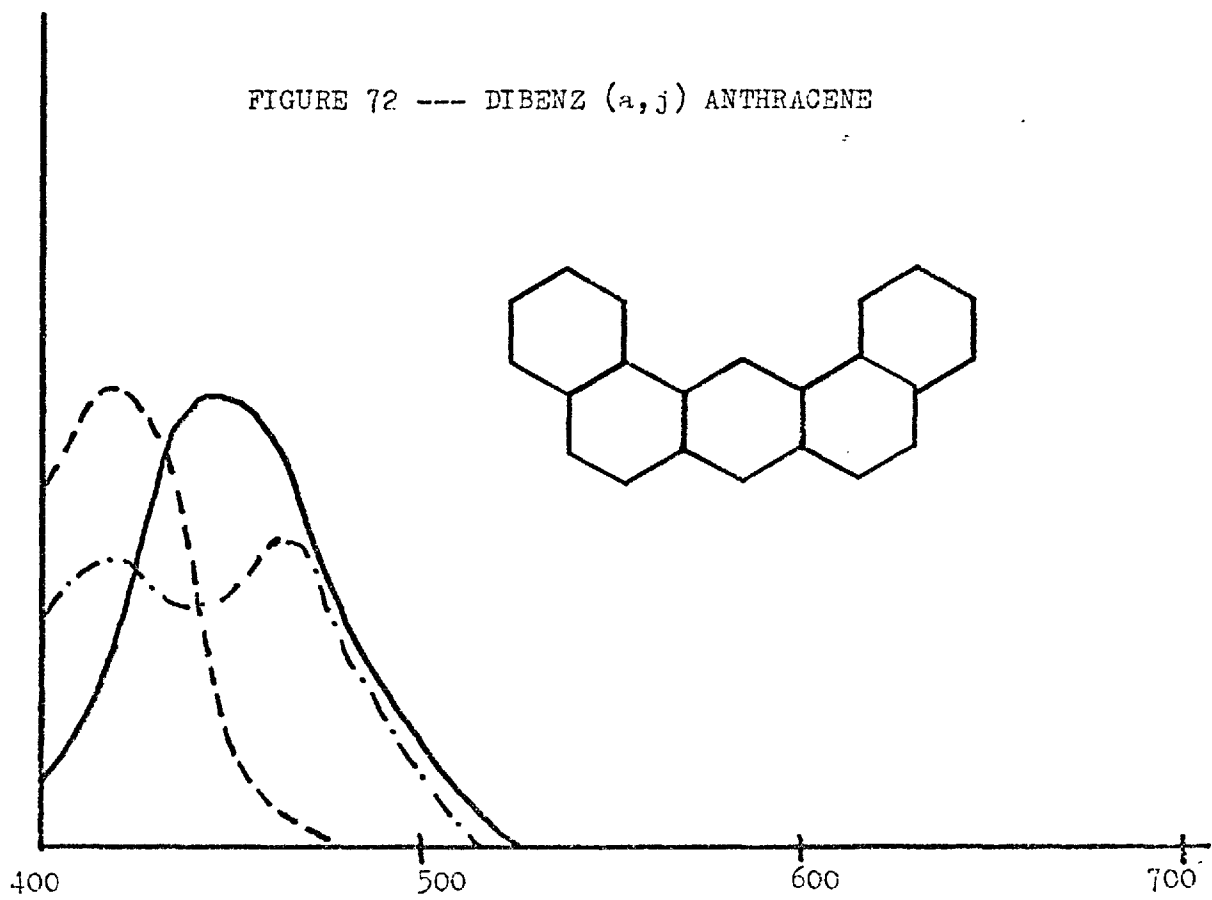

FIGURE 73 --- ACENAPHTHENE

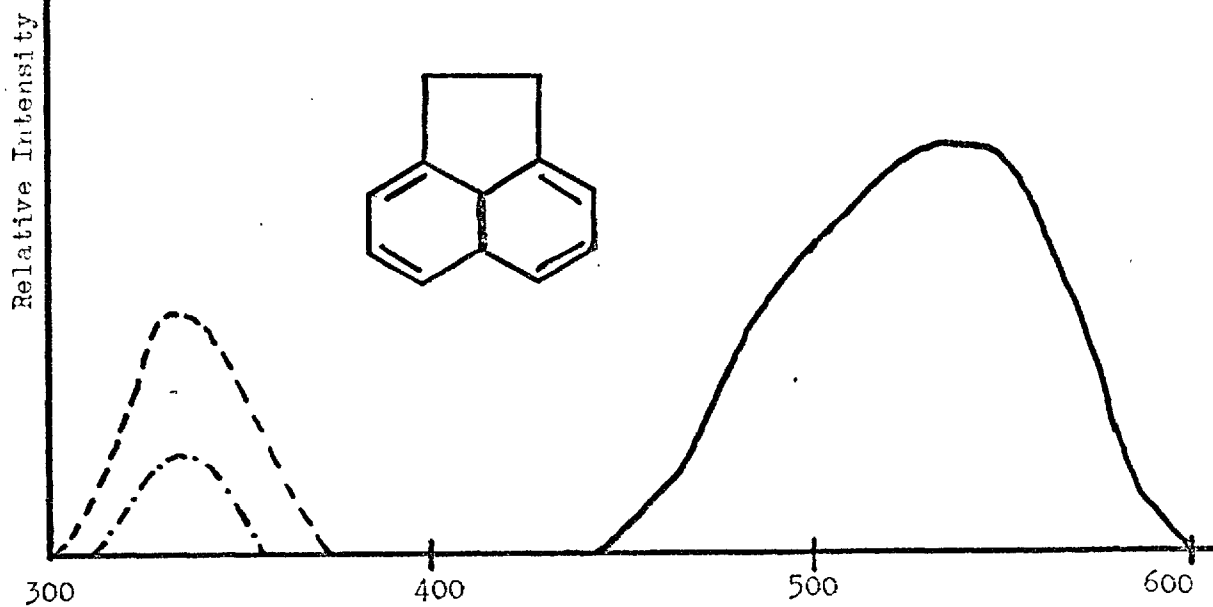
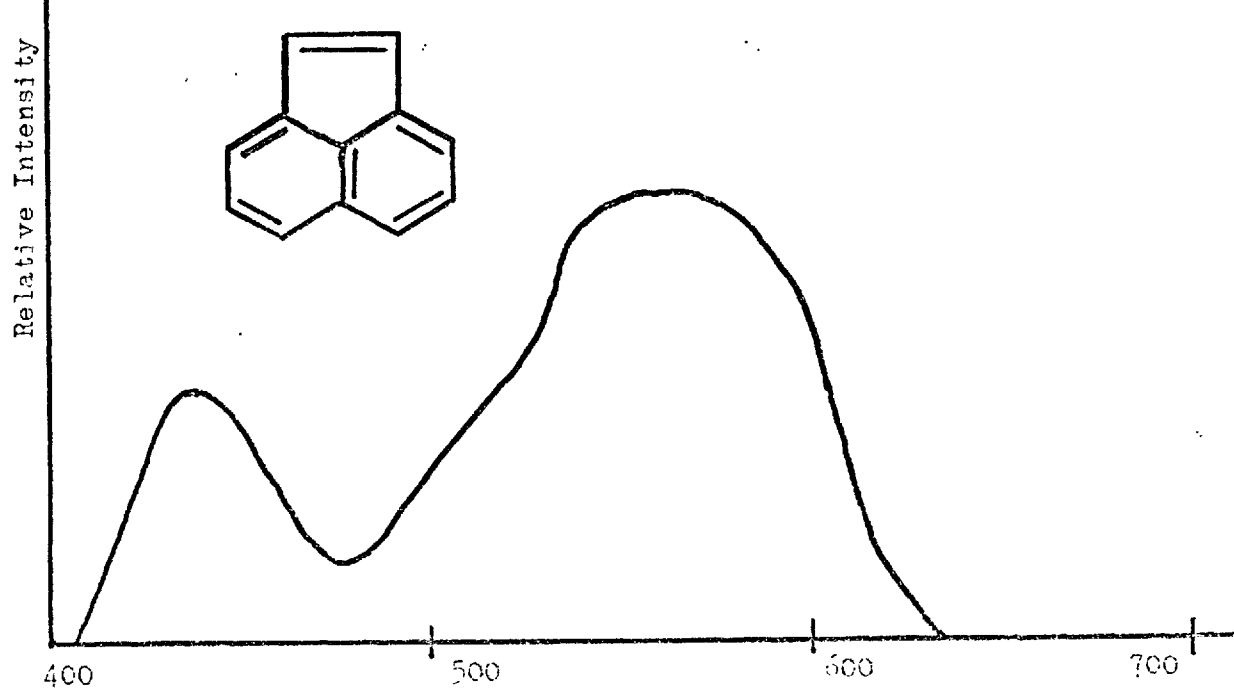

FIGURE 74 --- ACENAPHTHYLENE



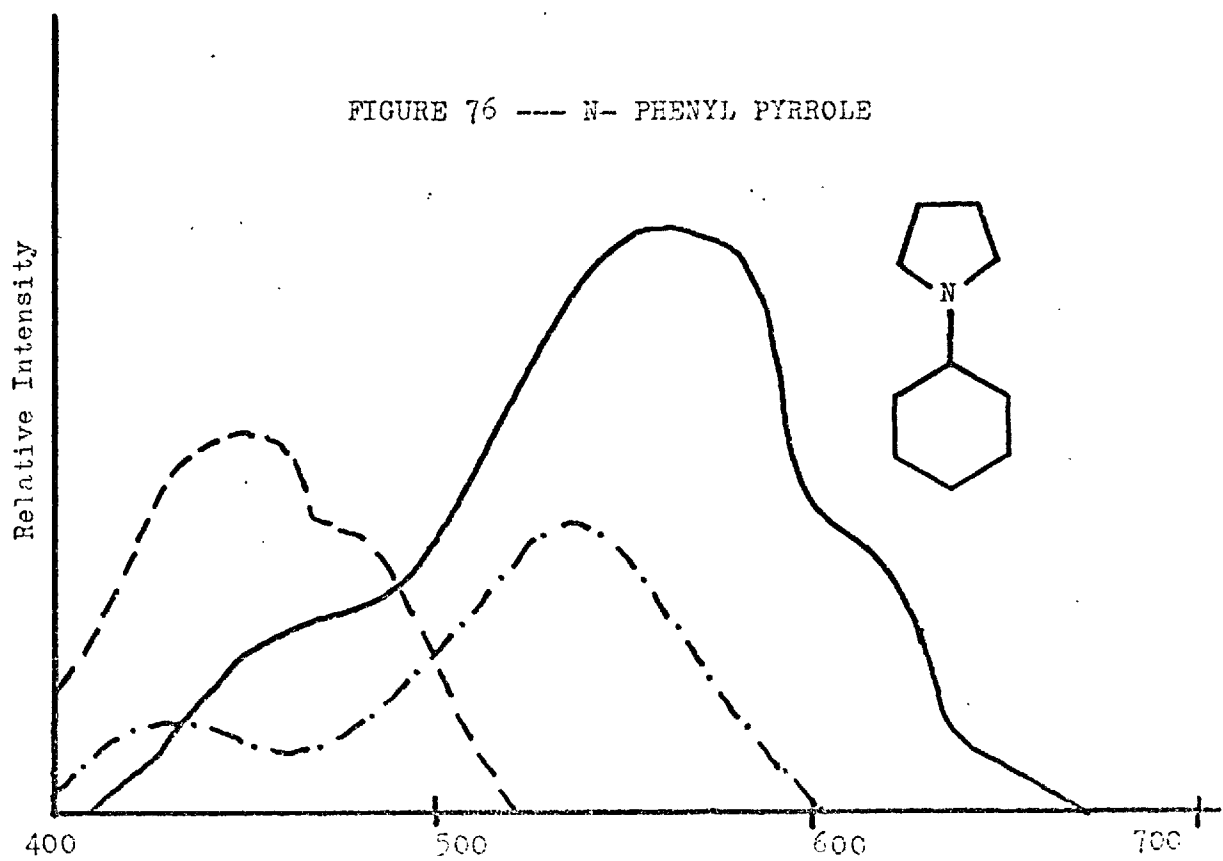
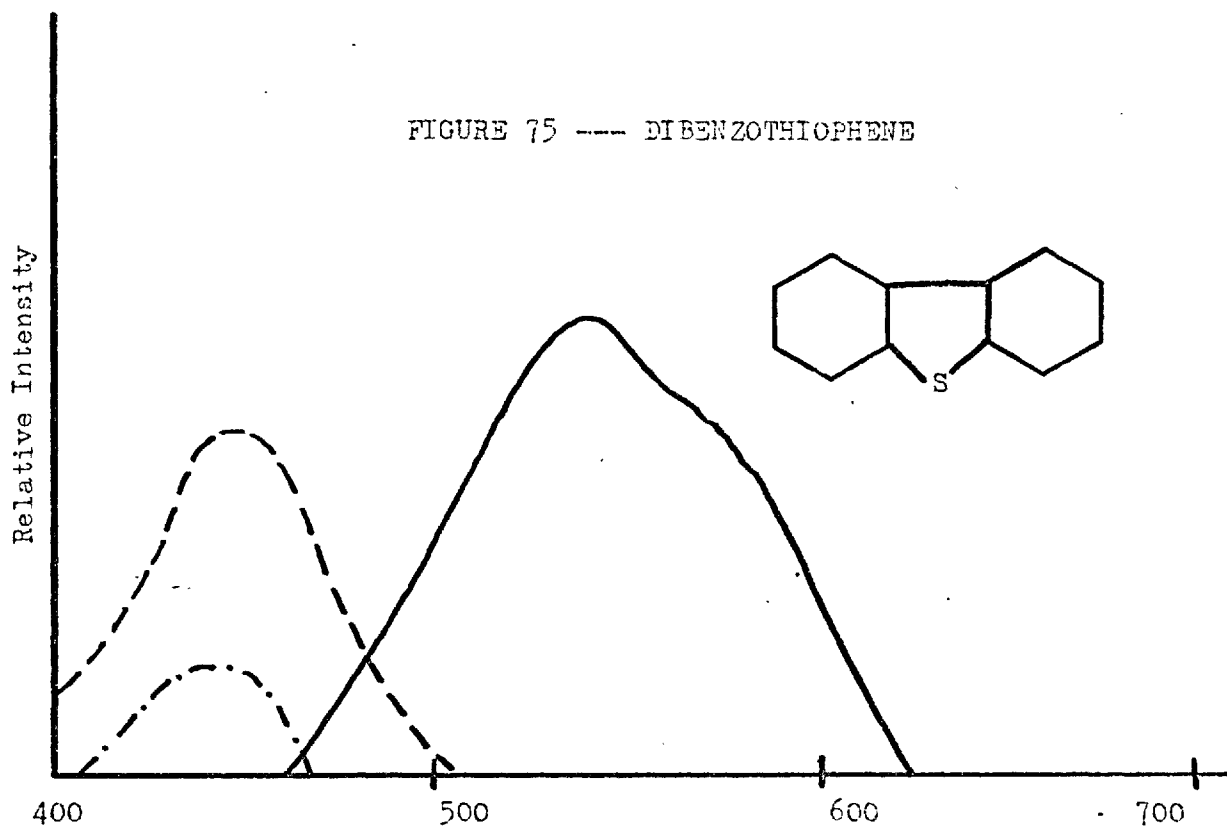

FIGURE 77 --- DIBENZOFURAN

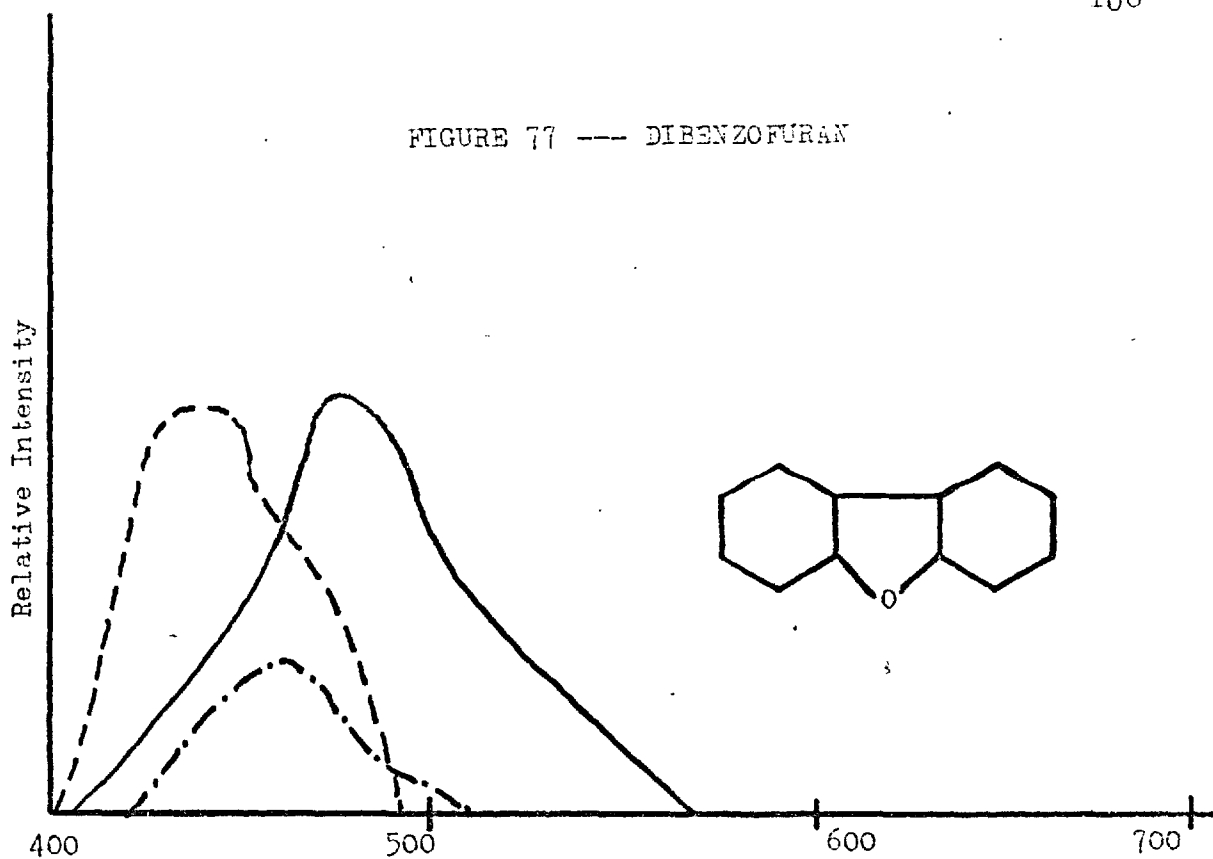
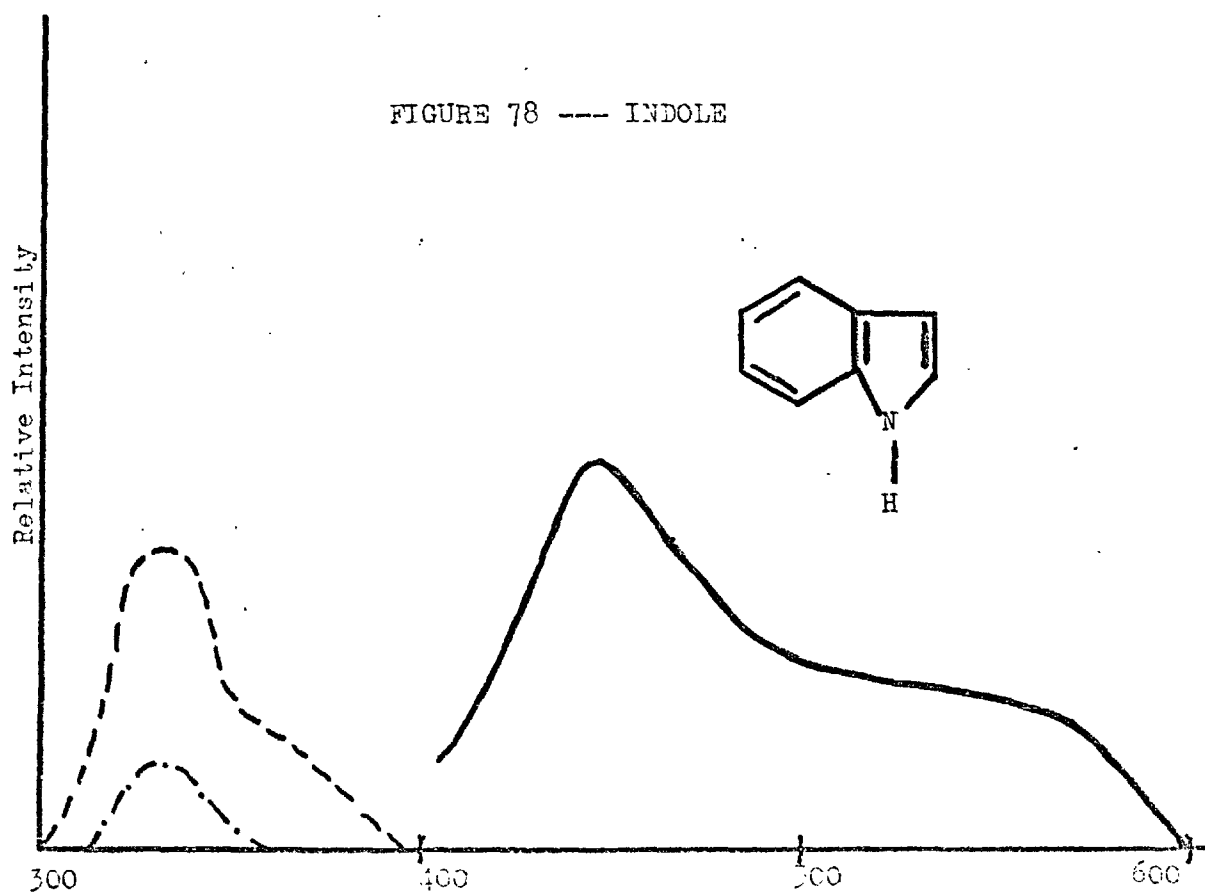
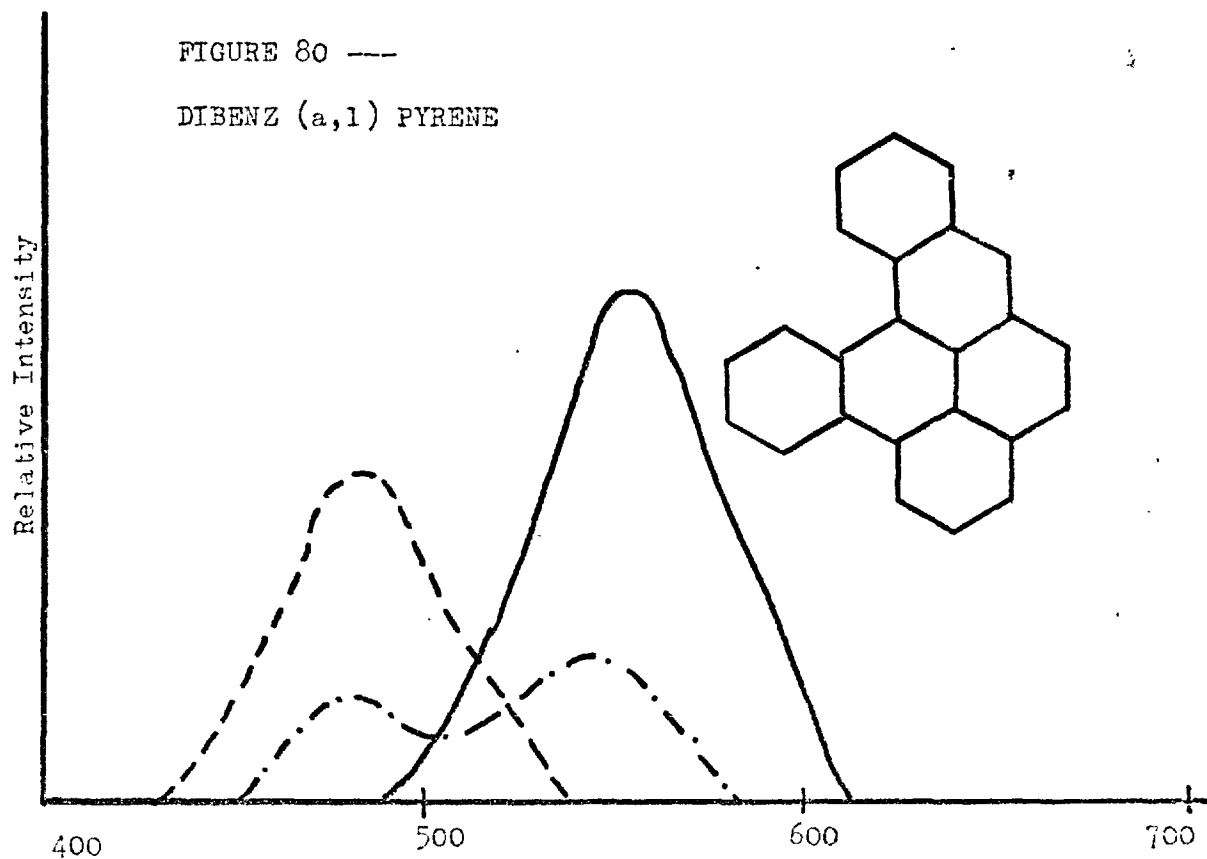
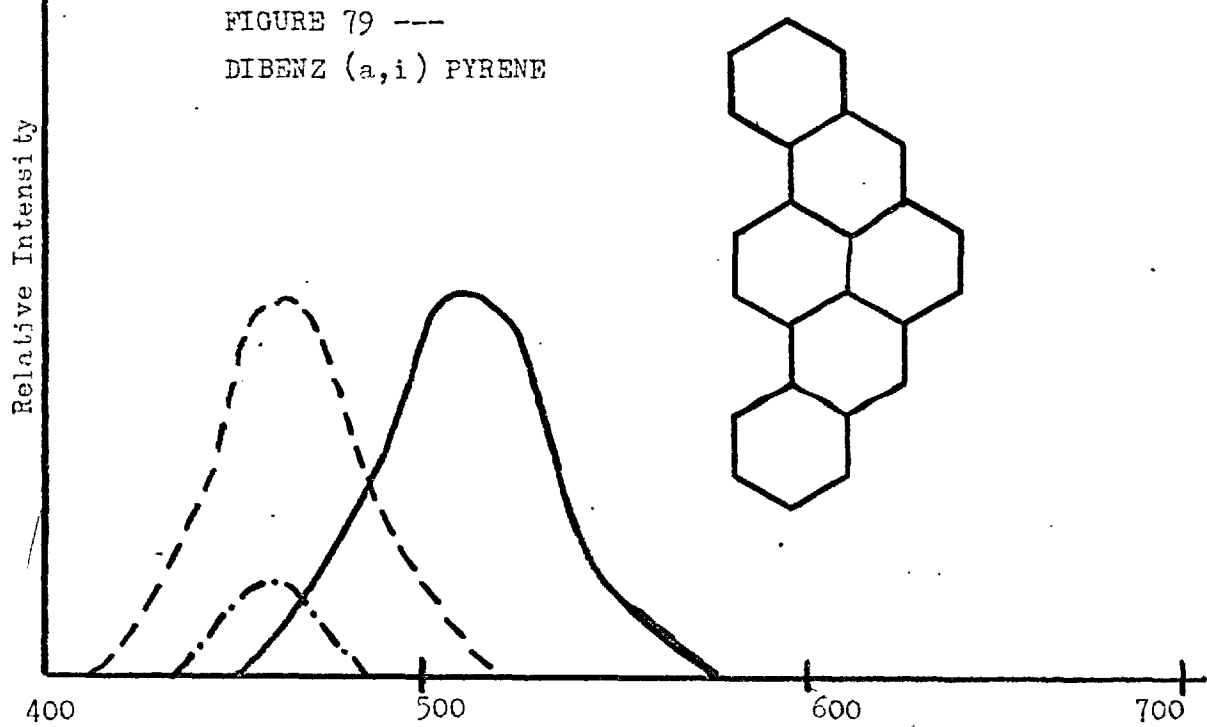
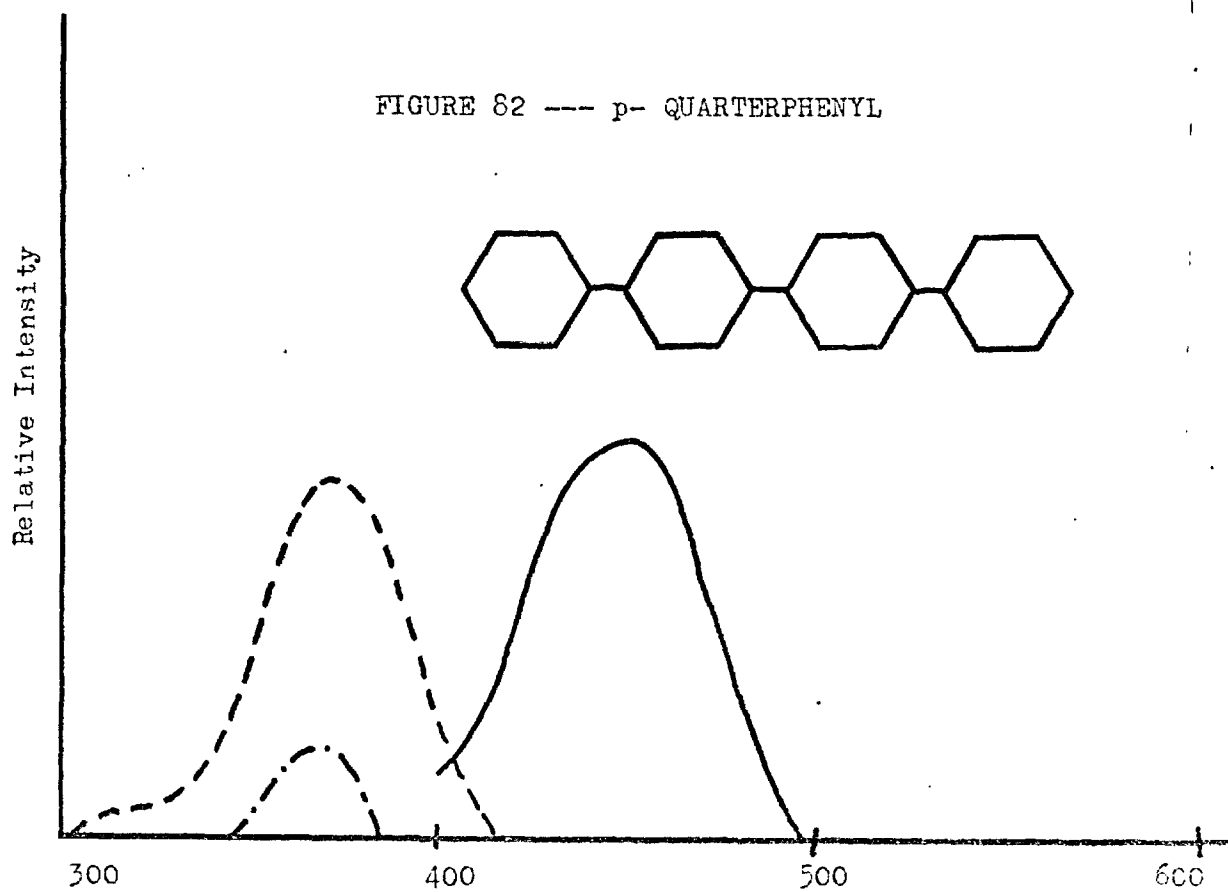
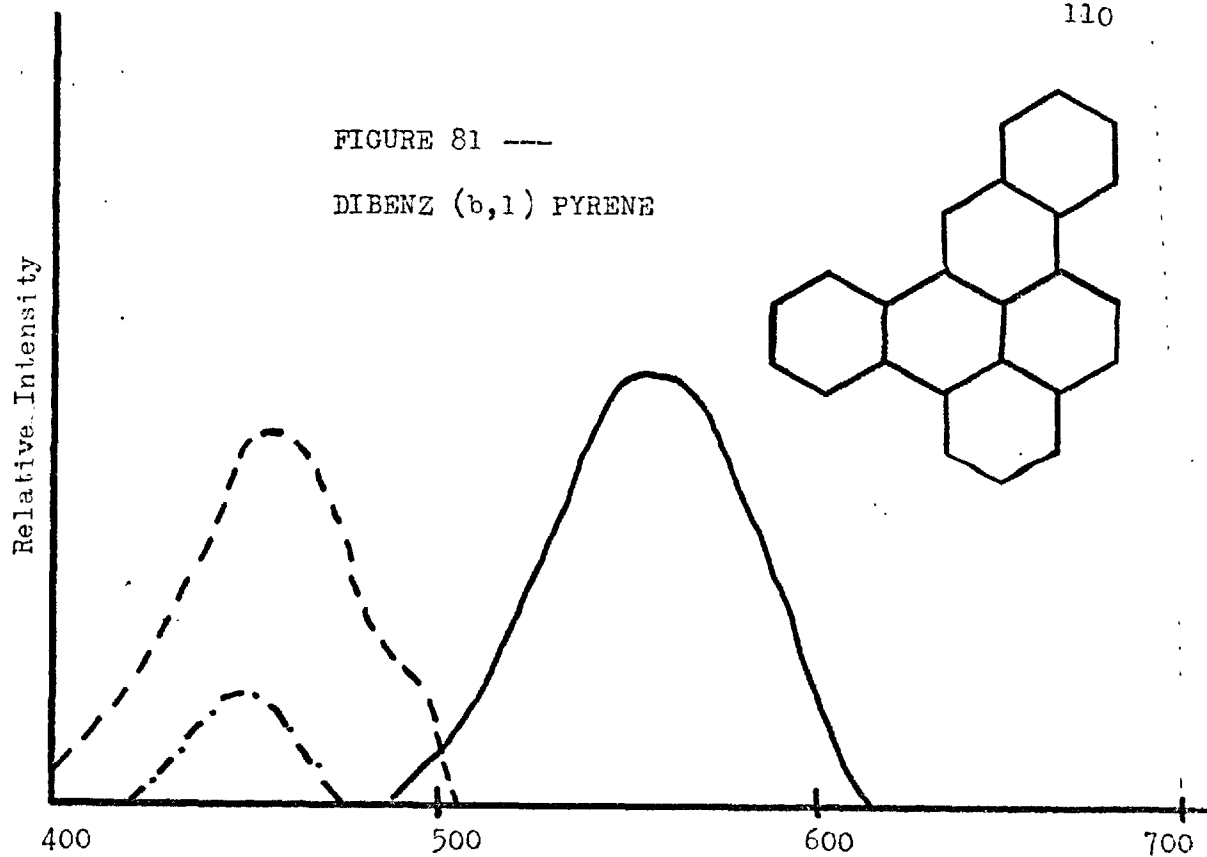
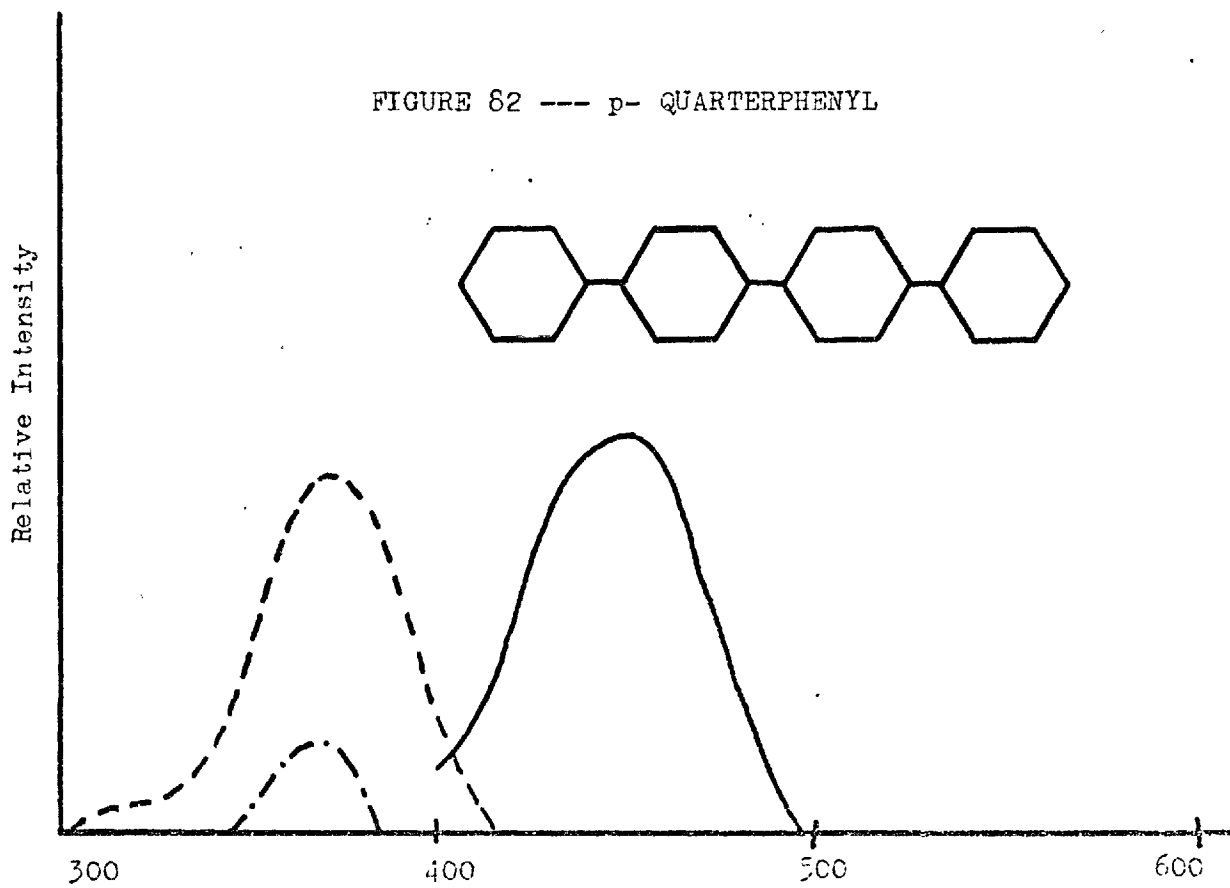
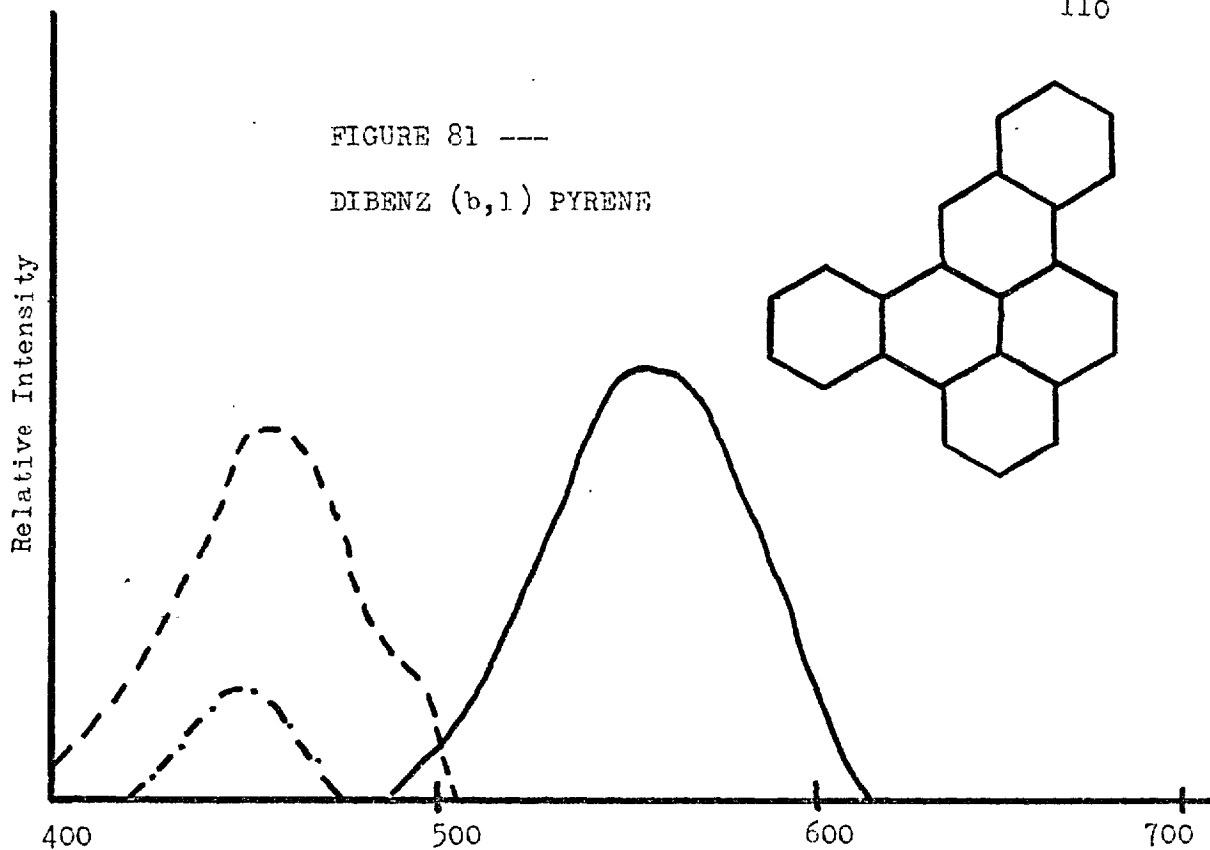

FIGURE 78 --- INDOLE









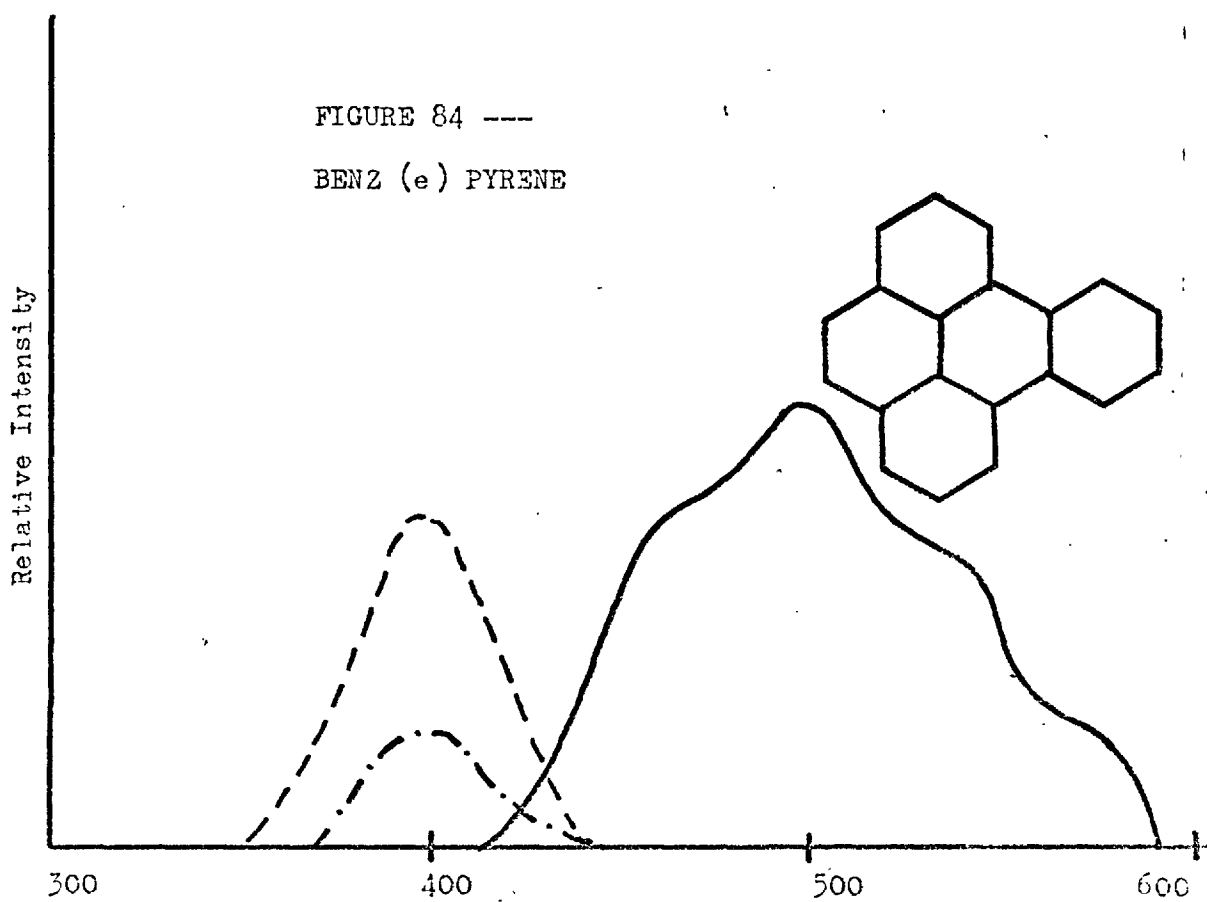
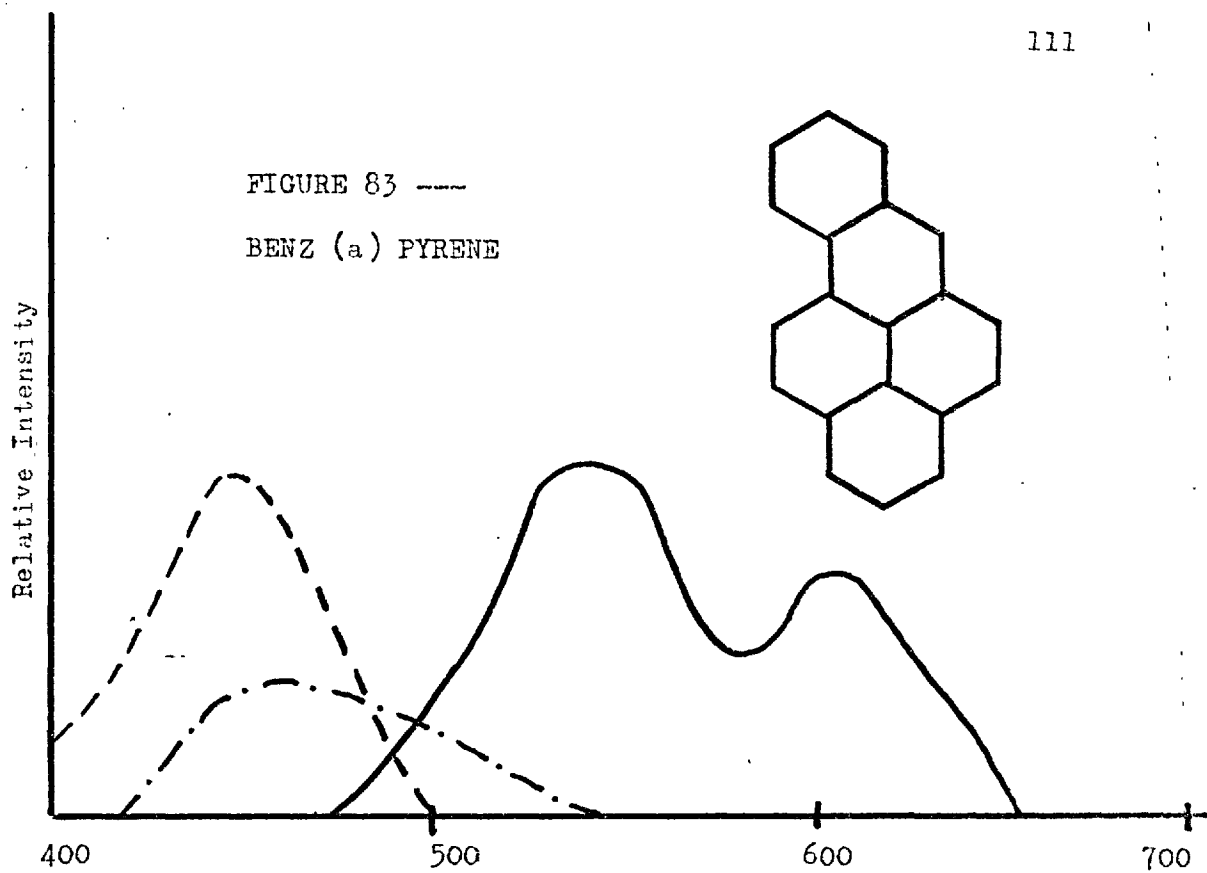

Figure 85 2,2-DINAPHTHYL

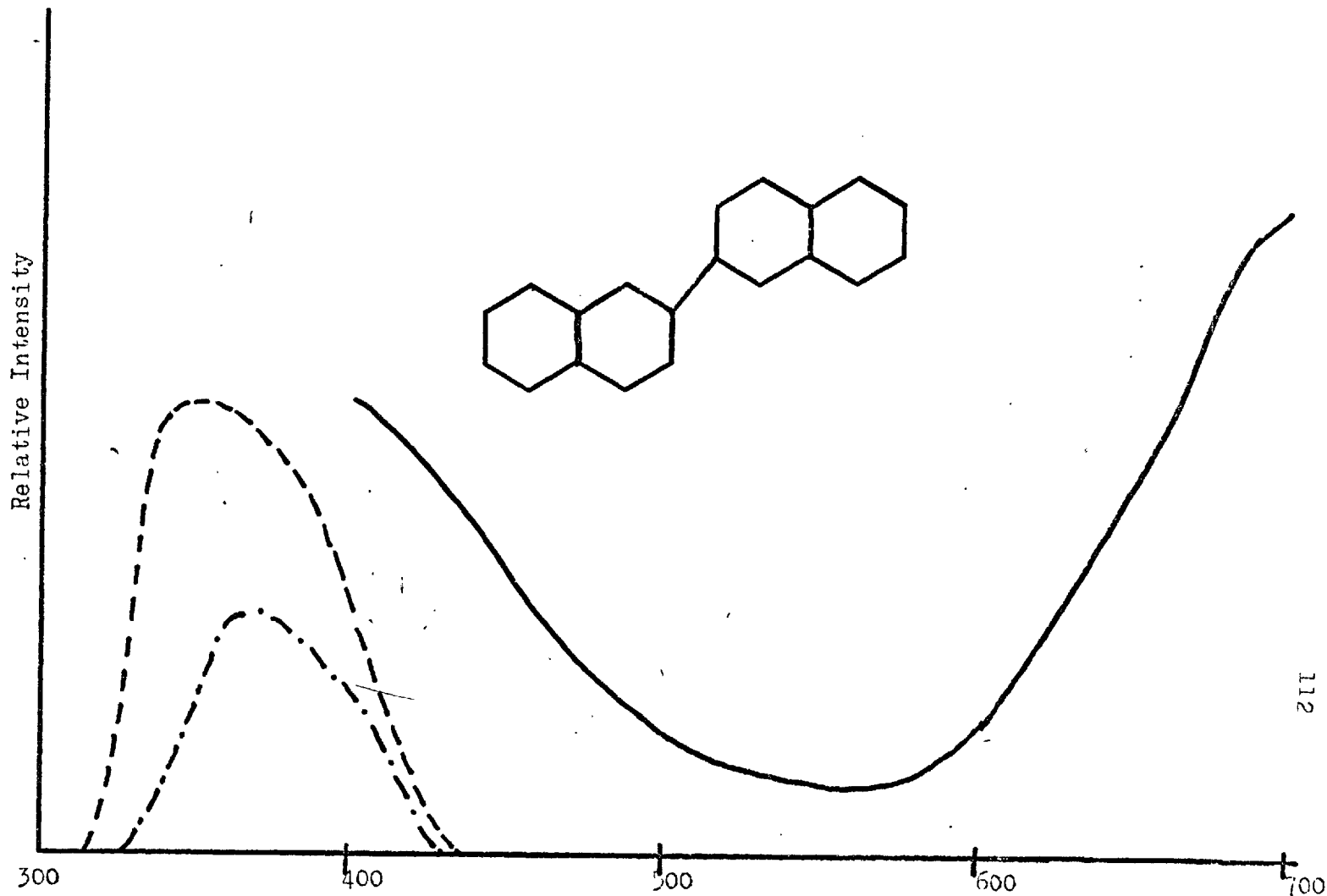

FIGURE 86 4,5-METHYLENE PHENANTHRENE

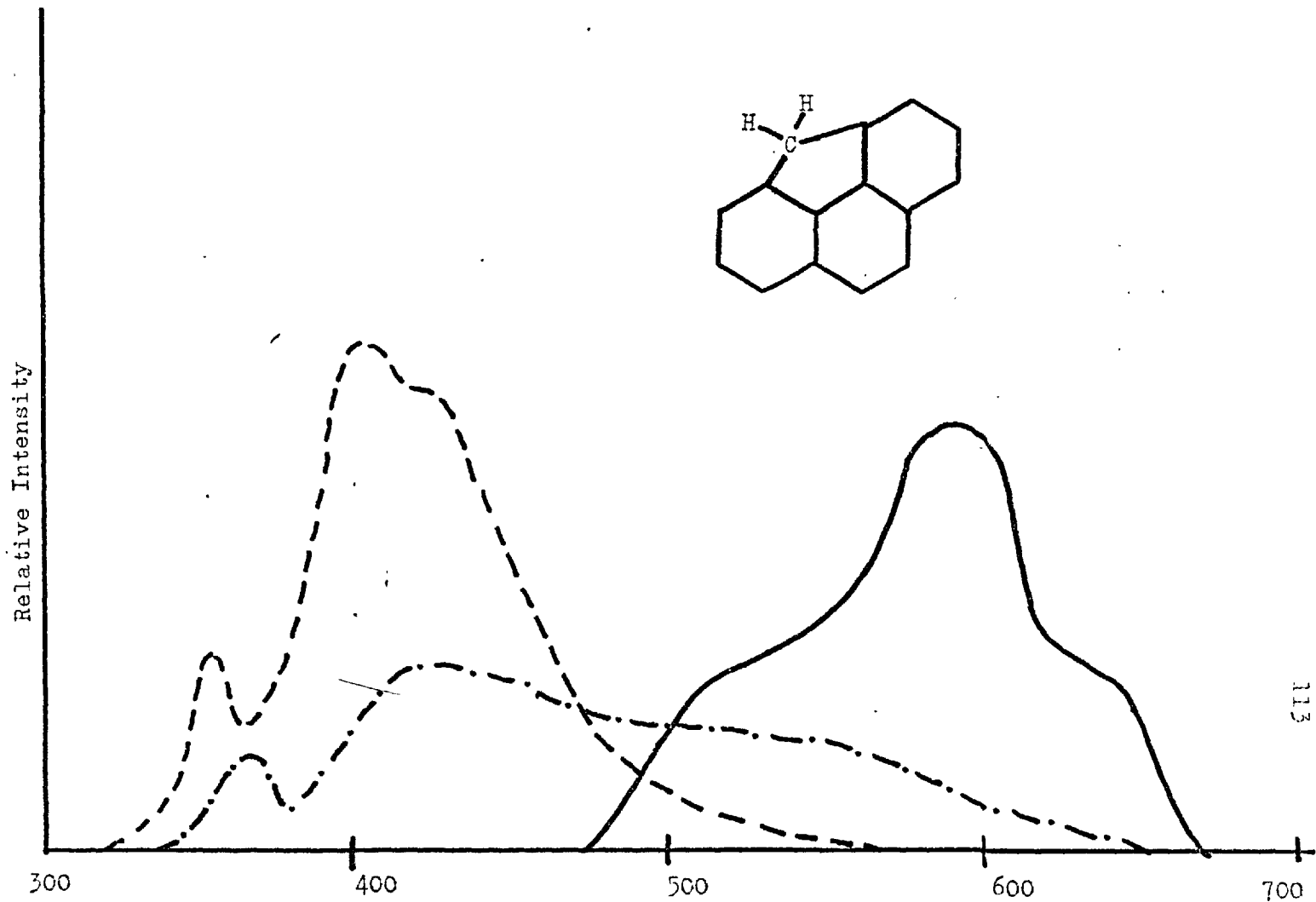

TABLE 6

FIGURE	COMPOUND	WAVE-FORM	POTENTIAL CONDITIONS	HZ.	FLUOR. EX.	MAJOR ECL REFERENCES
35	Anthracene	Square	\pm 3.5 V	30	340	6,11,12,34
36	Diphenyl anthracene	Square	\pm 3.0 V	30	360	11,12,46,53
37	9- Phenyl anthracene	Square	\pm 3.5 V	30	360	
38	Rubrene	Square	\pm 2.5 V	30	480	6,11,12,42,43,53
39	Rubicene	Square	\pm 3.0 V	20	460	
40	Coronene	Square	\pm 3.5 V	30	370	6,12
41	Perylene	Square	\pm 4.0 V	10	300	6
42	Chrysene	Square	\pm 3.5 V	30	330	6
43	Pyrene	Square	\pm 3.5 V	30	320	6,23
44	Naphthalene	Square	+ 2.0 ----- - 4.0 V	30	290	
45	p- Diphenylbenzene	Square	\pm 4.0 V	50	320	
46	m- Diphenylbenzene	Square	\pm 4.0 V	50	320	
47	o- Diphenylbenzene	Square	\pm 4.0 V	50	320	
48	m- Quinquephenyl	Square	\pm 4.0 V	30	300	
49	p- Quinquephenyl	Square	\pm 4.0 V	30	300	
50	Benzyl diphenyl	Square	\pm 3.5 V	1	280	
51	DPOT	Square	\pm 4.0 V	10	370	

TABLE 6 (continued)

FIGURE	COMPOUND	WAVE-FORM	POTENTIAL CONDITIONS	HZ.	FLUOR. EX.	MAJOR ECL REFERENCES
52	20- Methyl cholanthrene	Square	± 4.0 V	10	350	48
53	Fluoranthene	Square	± 3.5 V	30	360	
54	Picene ^a	Square	± 3.0 V	30	350	
55	Triphenylene	Square	± 3.5 V	50	290	
56	Phenanthrene	Square	± 3.0 V	50	300	11,23,29,31
57	Benzo(g,h,i)fluoranthene	Square	± 3.5 V	30	350	
58	Benzo(b) fluoranthene	Square	± 3.5 V	50	350	
59	9- Bromoanthracene	Square	± 3.5 V	30	340	
60	Anthanthrene	Square	+ 3.0 --- -4.0 V	1	390	
61	2- Phenyl-naphthalene	Square	+ 2.0 --- -4.0 V	50	290	
62	Benzo(g,h,i) perylene	Square	± 3.0 V	30	370	
63	Carbazole ^a	Square	± 4.0 V	30	330	11
64	2- Methoxynaphthalene ^a	Square	± 4.5 V	1	290	
65	5,7-Dimethylbenz(a) acridine	Triang.	± 4.0 V (uns.)	1	300	
66	TPCPD	Square	+ 2.0 --- -4.0 V	5	360	

TABLE 6 (continued)

FIGURE	COMPOUND	WAVE-FORM	POTENTIAL CONDITIONS	HZ.	FLUOR. EX.	MAJOR ECL REFERENCES
67	Periflanthene ^a	Square	± 5.0 V	40	300	
68	o- Phenylene pyrene	Square	± 3.5 V	30	280	
69	1 - Methyl pyrene	Square	± 4.5 V	5	340	
70	DB (a,c) A	Square	± 4.0 V	30	300	
71	DB (a,h) A	Square	± 4.0 V	30	330	6
72	DB (a,j) A	Square	± 3.5 V	10	360	
73	Acenaphthene	Square	± 4.0 V	1	270	
74	Acenaphthylene	Triang.	± 4.0 V	1	No. Fluor. Det.	
75	Dibenzothiophene	Square	± 4.0 V	30	340	
76	N- Phenyl pyrrole	Triang.	± 3.5 V	10	300	
77	Dibenzofuran	Square	± 4.0 V	30	320	
78	Indole ^a	Triang.	$+2.0$ ----- -4.0 V	1	280	
79	DB (a,i) P	Square	± 3.5 V	30	380	
80.	DB (a,l) P	Square	± 3.5 V	30	400	
81	DB (b,l) P	Square	± 3.5 V	30	360	
82	Quarterphenyl ^a	Square	± 4.5 V	50	290	

TABLE 6 (continued)

FIGURE	COMPOUND	WAVE-FORM	POTENTIAL CONDITIONS	HZ.	FLUOR. EX.	MAJOR ECL REFERENCES
83	Benz(a) pyrene	Square	± 3.5 V	30	370	
84	Benz(e) pyrene	Square	± 3.5 V	10	320	
85	2,2'- Dinaphthyl	Square	± 3.5 V	40	320	
86	4,5- Methylene- ^a phenanthrene	Square	± 4.0 V	30	280	

a - Electrolysis for 30 minutes

As can be seen from consideration of Figures 35-86, a wide variety of behaviour was observed for the ECL of aromatic compounds under the conditions noted. The spectra are presented under "normal" ideal conditions, at higher potentials other types of behaviour were often noted. Most compounds showed new peaks at very high potentials, these peaks were also observed to change with time. Figure 87 shows the ECL spectra of picene under various conditions. At relatively low potentials, fewer compounds showed change of the shape of the spectrum with time. One which did, however, was benzo(b) fluoranthene. It was observed that a new peak at 510 nm built up as the original peak at 440 nm decayed. This is shown in Figure 88. The new ECL peak at 510 nm was also observable (Figure 58) on the post-ECL fluorescence spectrum.

When a post-ECL solution was excited at wavelengths other than the original exciting wavelength, it was often possible to show more clearly formation of a new species in the solution. This is shown for anthanthrene in Figure 89.

The ECL spectrum (Figure 85) of 2,2'-dinaphthyl is particularly interesting. It was confirmed that the ECL decay at 420 nm and 680 nm was at the same rate, therefore indicating the same species causing ECL at both wavelengths. It is most likely that emission at the very long wavelengths is caused by a harmonic of emission in the 340-350 nm range. 2,2'-dinaphthyl was a particularly strong ECL emitter.

When solutions of 2,2'-dinaphthyl were electrolysed at very high potentials (over 5 V) a new peak at 440-460 nm was observed. Emission at these wavelengths continued even if the potential was decreased to 3.5 V. It is at least a possibility that this emission is caused by 2,2'-dinaphthyl bond splitting to form two naphthalene molecules.

In order to ascertain whether shifts of pre- and post-ECL phosphorescence peaks had occurred, spectra were recorded on the Aminco-Bowman at 77° K (cooled by liquid nitrogen) for several compounds. As DMF does not form a clear glass necessary for phosphorescence measurements, it was necessary to use a 10-90 DMF-E.P.A. solution, the effective concentration of the emitter then being 10^{-4} M. E.P.A. is one of the usual solvents for low temperature phosphorescence work⁶⁹ and consists of a 5:5:2 V:V:V mixture of ether, isopentane, and ethanol.

Rubrene and rubicene did not show pre- or post-ECL phosphorescence peaks, phenanthrene showed no change in its phosphorescence spectrum except for a decrease in intensity. The same behaviour was noted for 4,5-methylene phenanthrene. The phosphorescence spectrum for this compound was markedly similar to its ECL spectrum (Figure 86) indicating a possible triplet mechanism.

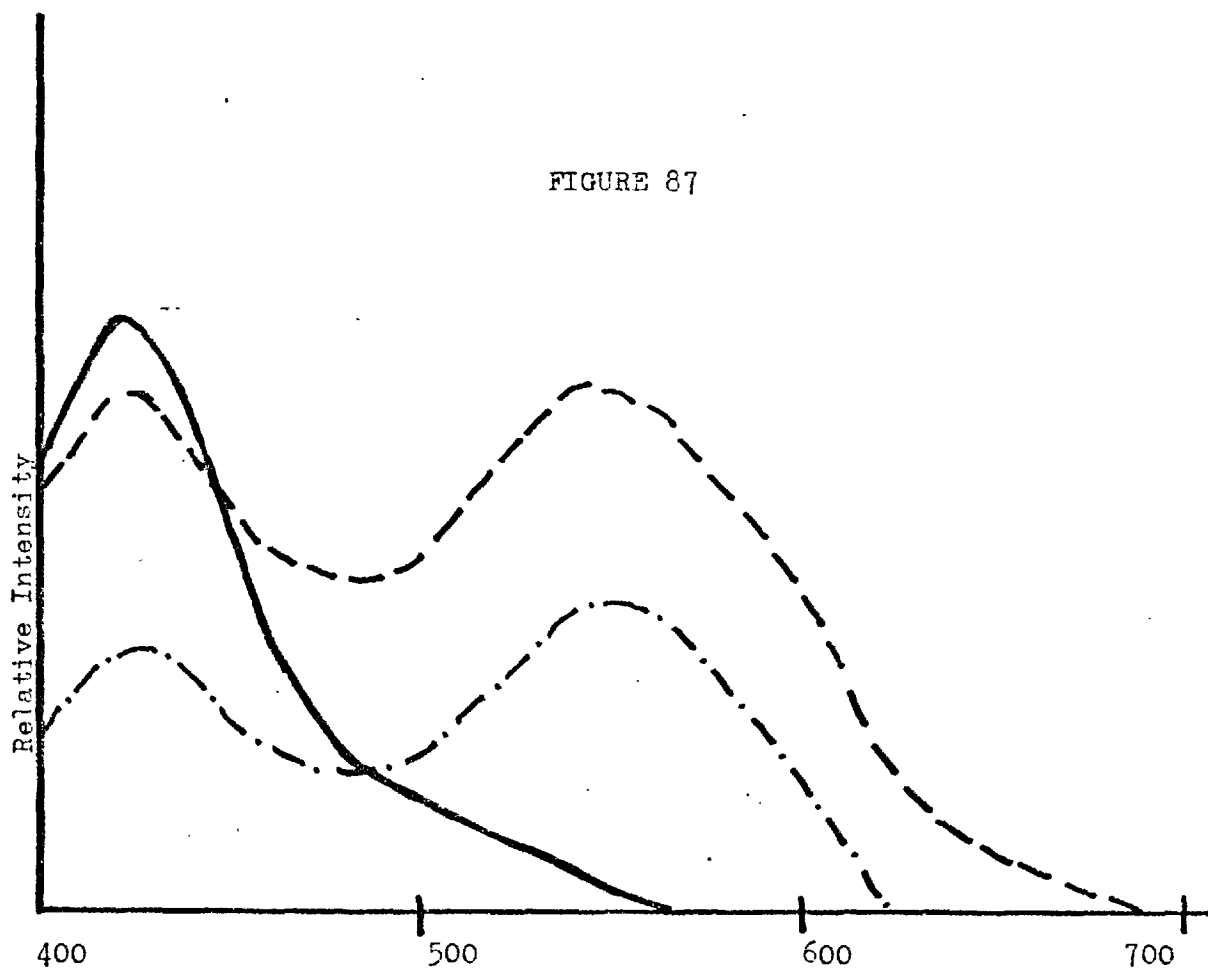

- A) ECL spectrum of picene at 3.0 V square wave, 30 Hz
- B) ECL spectrum of picene at 5.0 V square wave, 30 Hz
- C) ECL spectrum of picene at 5.0 V square wave, 60 Hz

FIGURE 88

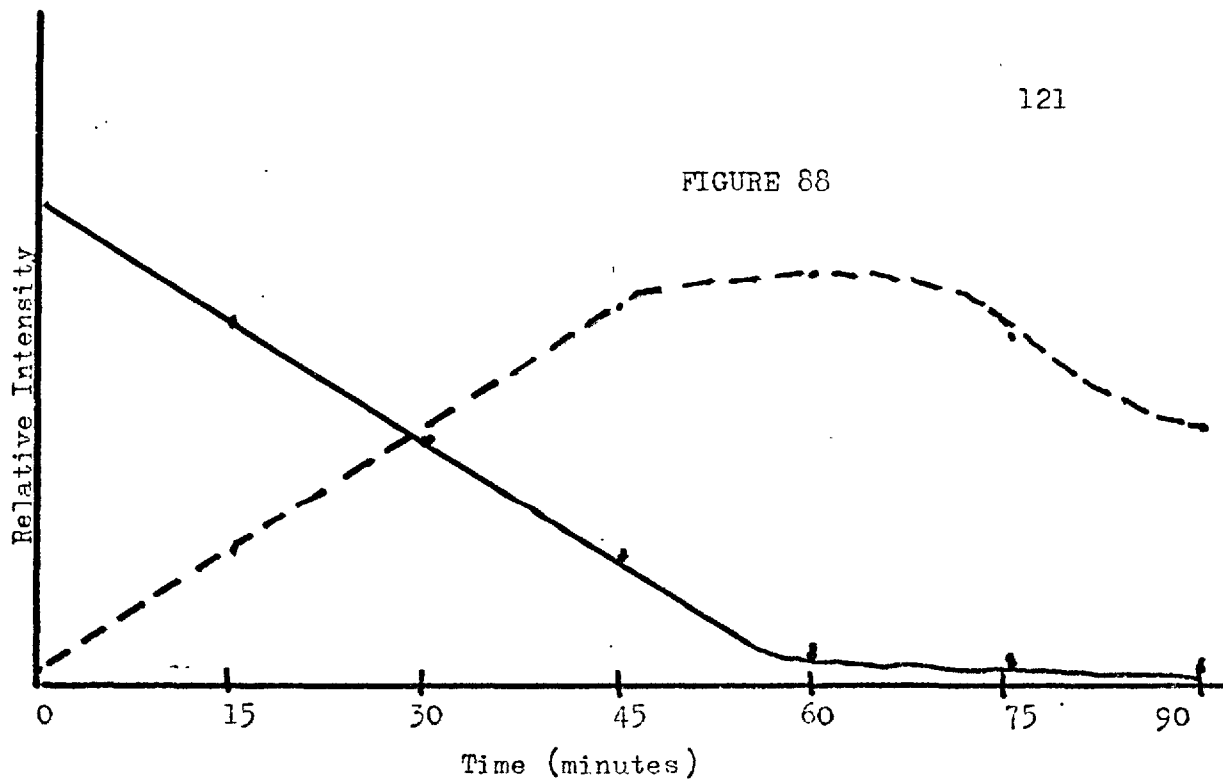

Intensity of benzo(b) fluoranthene, ± 3.5 V 50 Hz. A) 440 nm; B) 510 nm

FIGURE 89

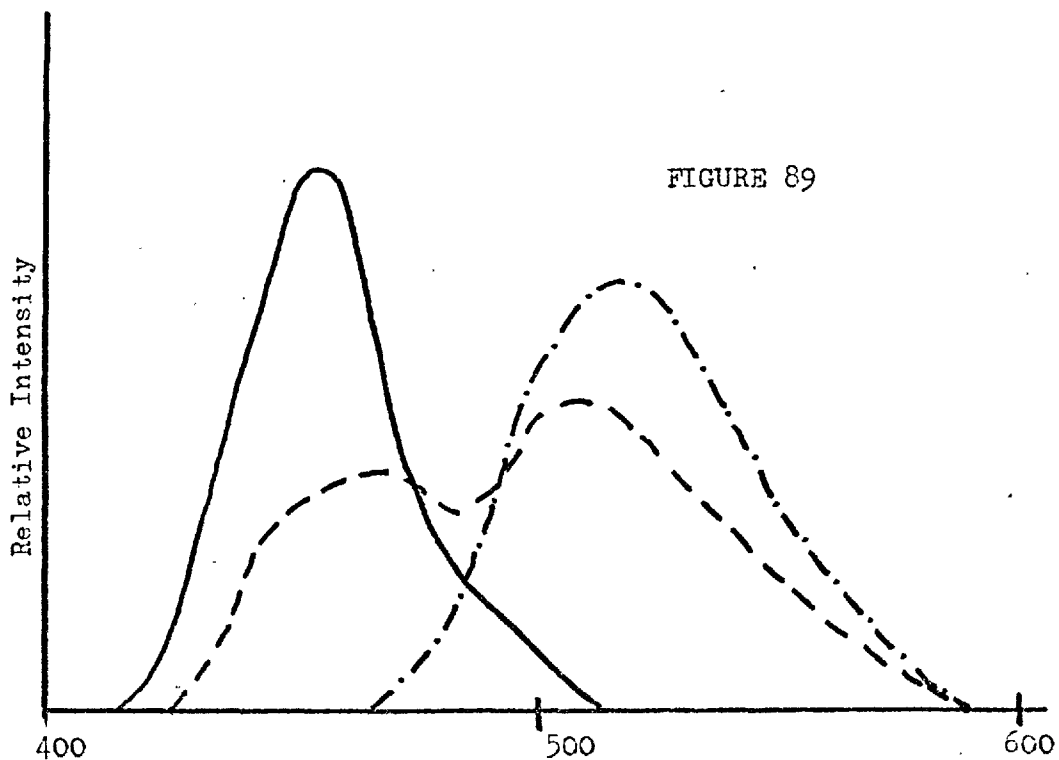

- A) Pre-ECL fluorescence, ex. 390 nm
- B) Post-ECL fluorescence, ex. 390 nm
- C) Post-ECL fluorescence, ex. 450 nm

CHAPTER FOUR

ANALYTICAL CONSIDERATIONS

4.1 Identification of Compounds by ECL Spectral Characteristics

The use of ECL spectra for the identification of aromatic compounds immediately suggests itself. A large number of polynuclear aromatic compounds are reported to be present in cigarette smoke⁴⁷. The major carcinogenic hydrocarbon is reported to be benz(a) pyrene which occurs in smoke condensates in levels of about 1-2 ppm; other carcinogenic hydrocarbons are generally reported to be present in lower concentrations with the possible exception of chrysene⁷⁰. Although it is a carcinogen, 20-methyl cholanthrene has not been reported in cigarette smoke.

Gas chromatography is the usual method of separation, due to the low concentration of polynuclear hydrocarbons in smoke condensate, however, it is not practical to inject whole smoke onto a gas chromatograph. Ayres and Thornton^{71,72} have devised rather elaborate separation schemes for several compounds including benz(a) pyrene.

Determination of the separated compounds is often made by consideration of their fluorescence spectra, identification is often tentative, however, because of the similarity of spectra for many compounds. Comparison between ECL and fluorescence and phosphorescence spectra could lead to the identification of many compounds which at present appear as

unknown peaks on gas chromatograms.

4.2 Concentration-Intensity Relationships

ECL intensity was found to be logarithmically proportional to concentration although deviations were observed at higher concentration ranges for several compounds. Results are shown in Figures 90-99. The range is extremely good and the sensitivity using the cell assembly described is slightly better than with conventional fluorescence. By using a miniature cell assembly, it would be possible to increase the limit of detection. For all concentration-intensity plots, it was found necessary to keep all other parameters constant; ECL intensity was measured within a minute of application of the potential at the wavelength of maximum intensity.

FIGURE 90 --- DIPHENYL ANTHRACENE (430 nm)

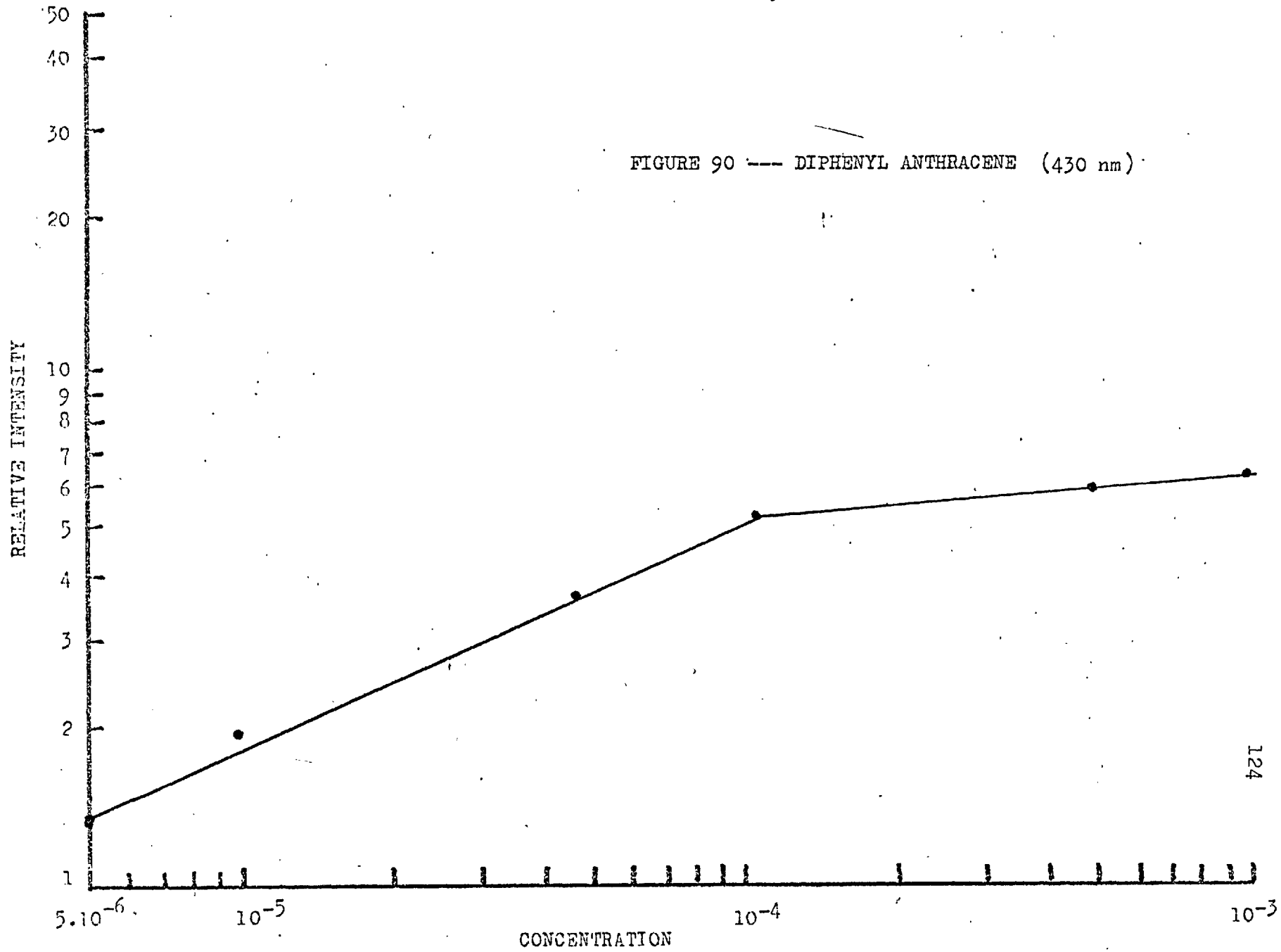

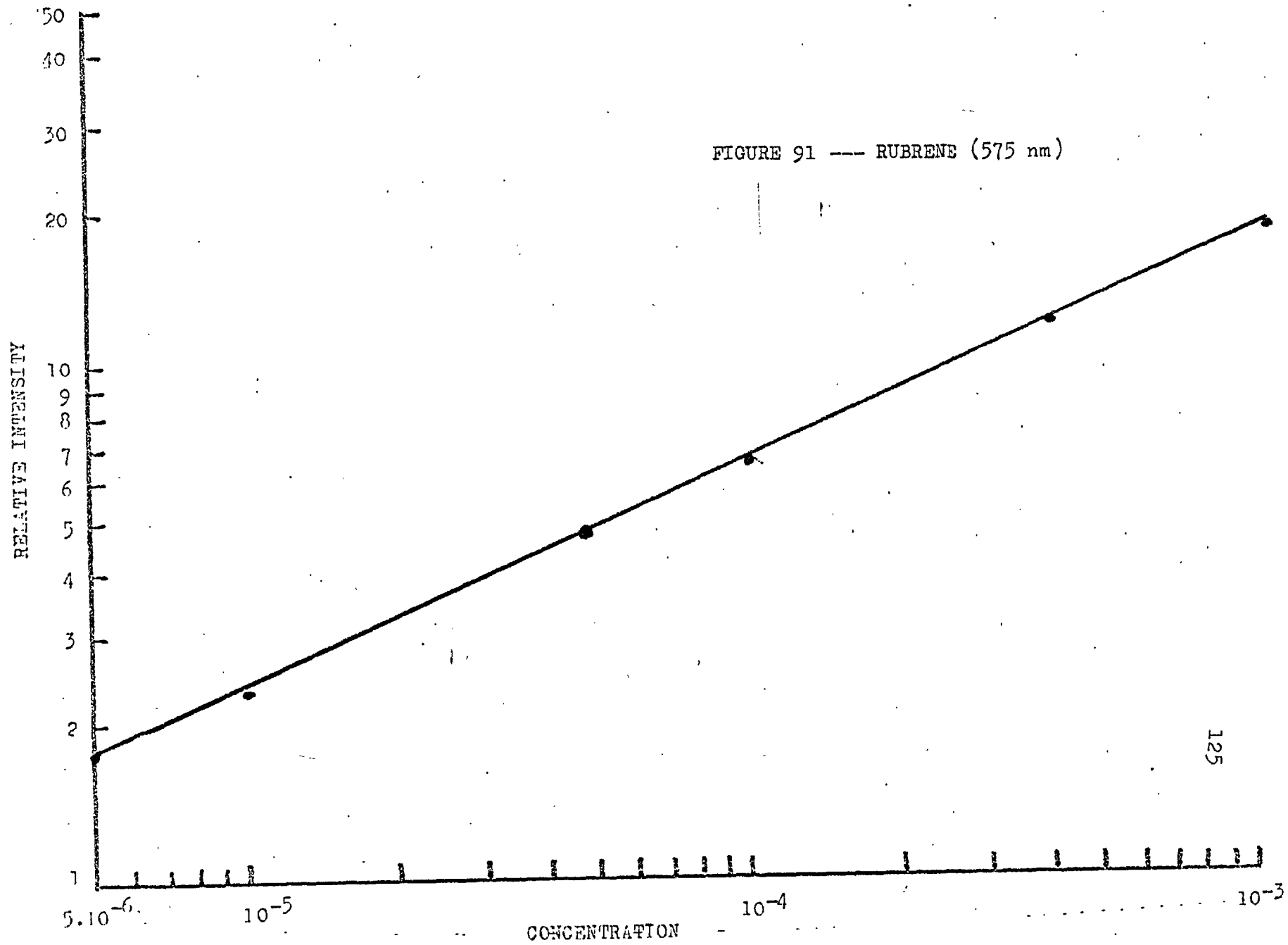

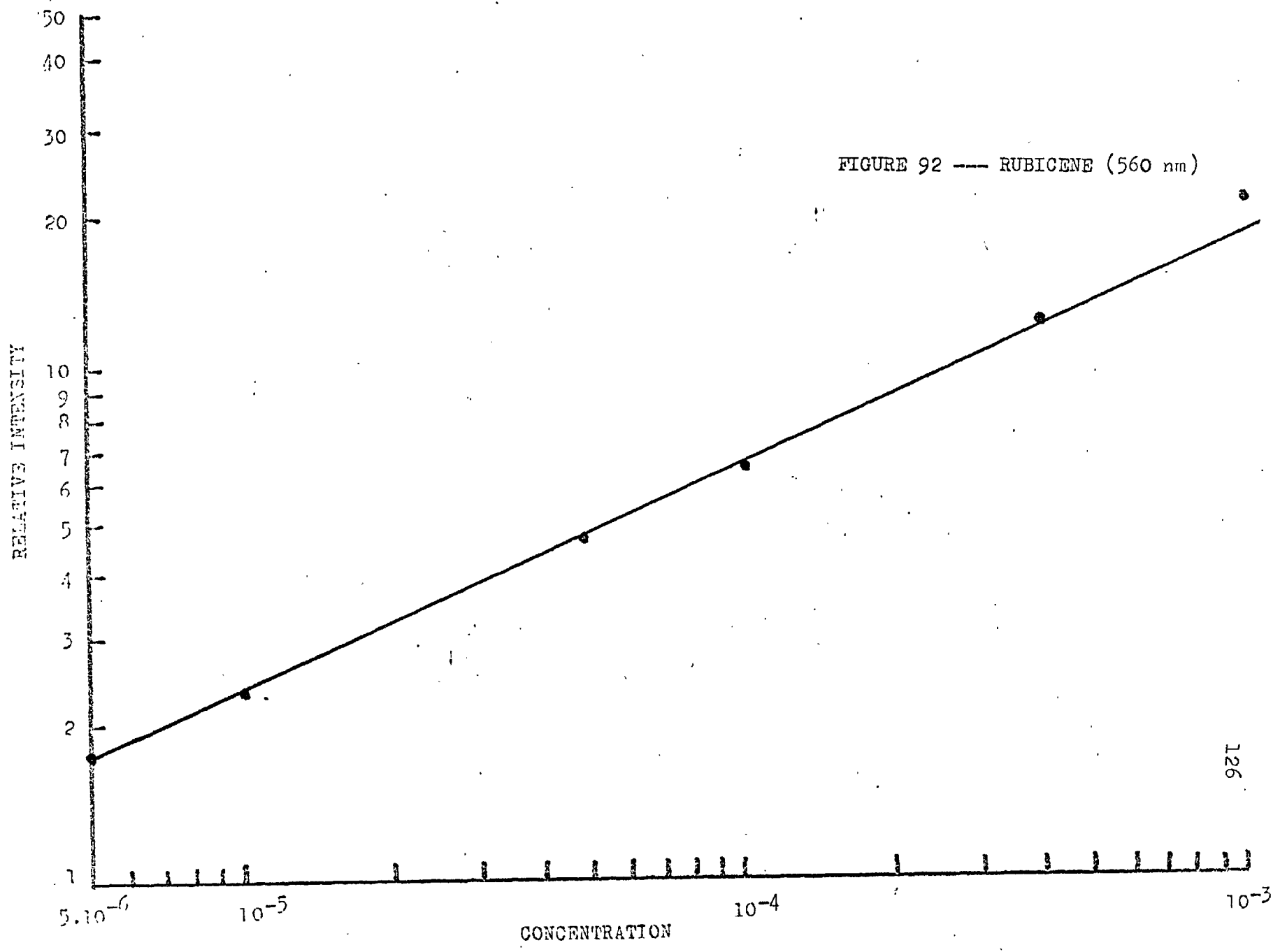
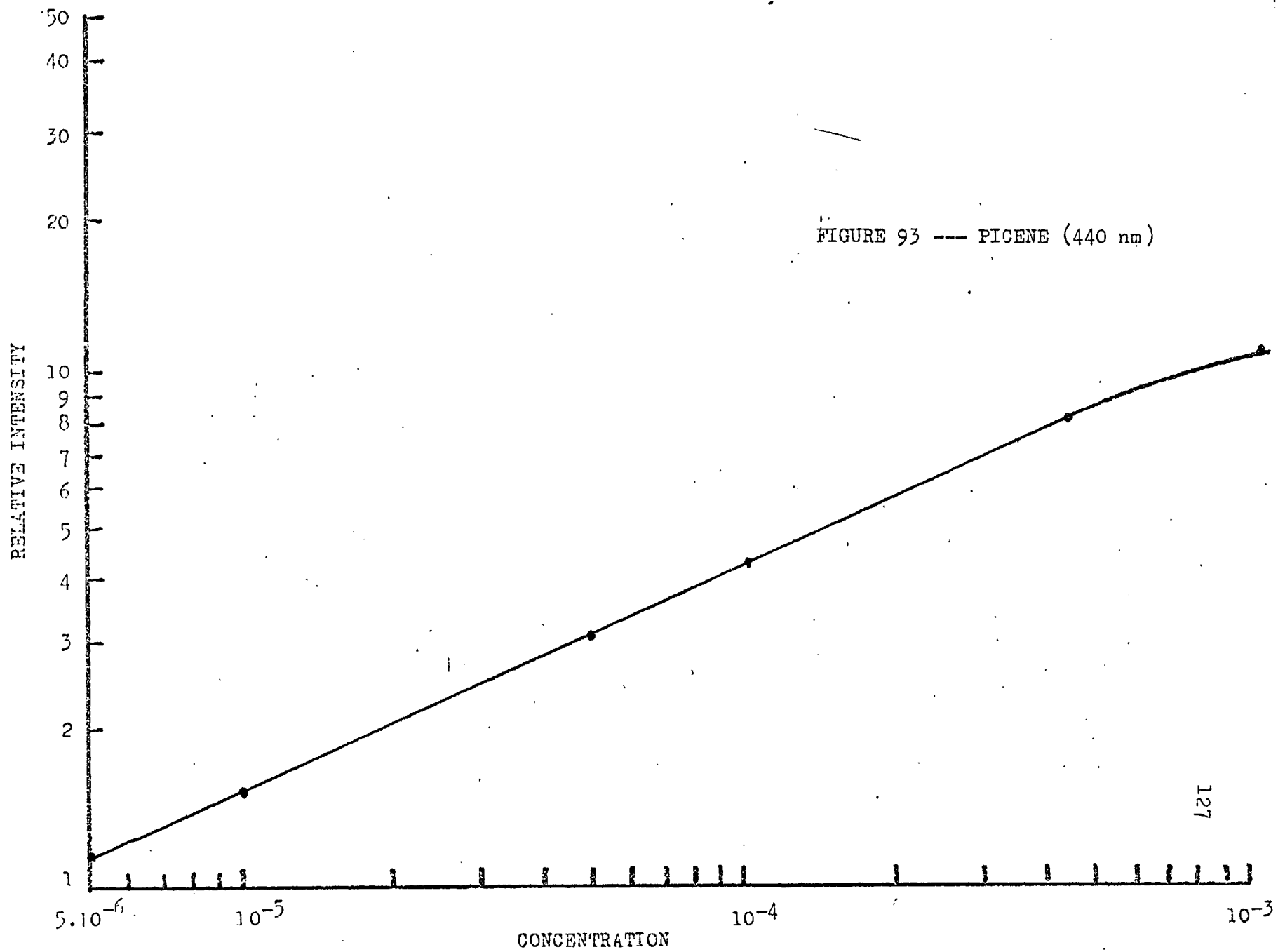

FIGURE 92 --- RUBICENE (560 nm)



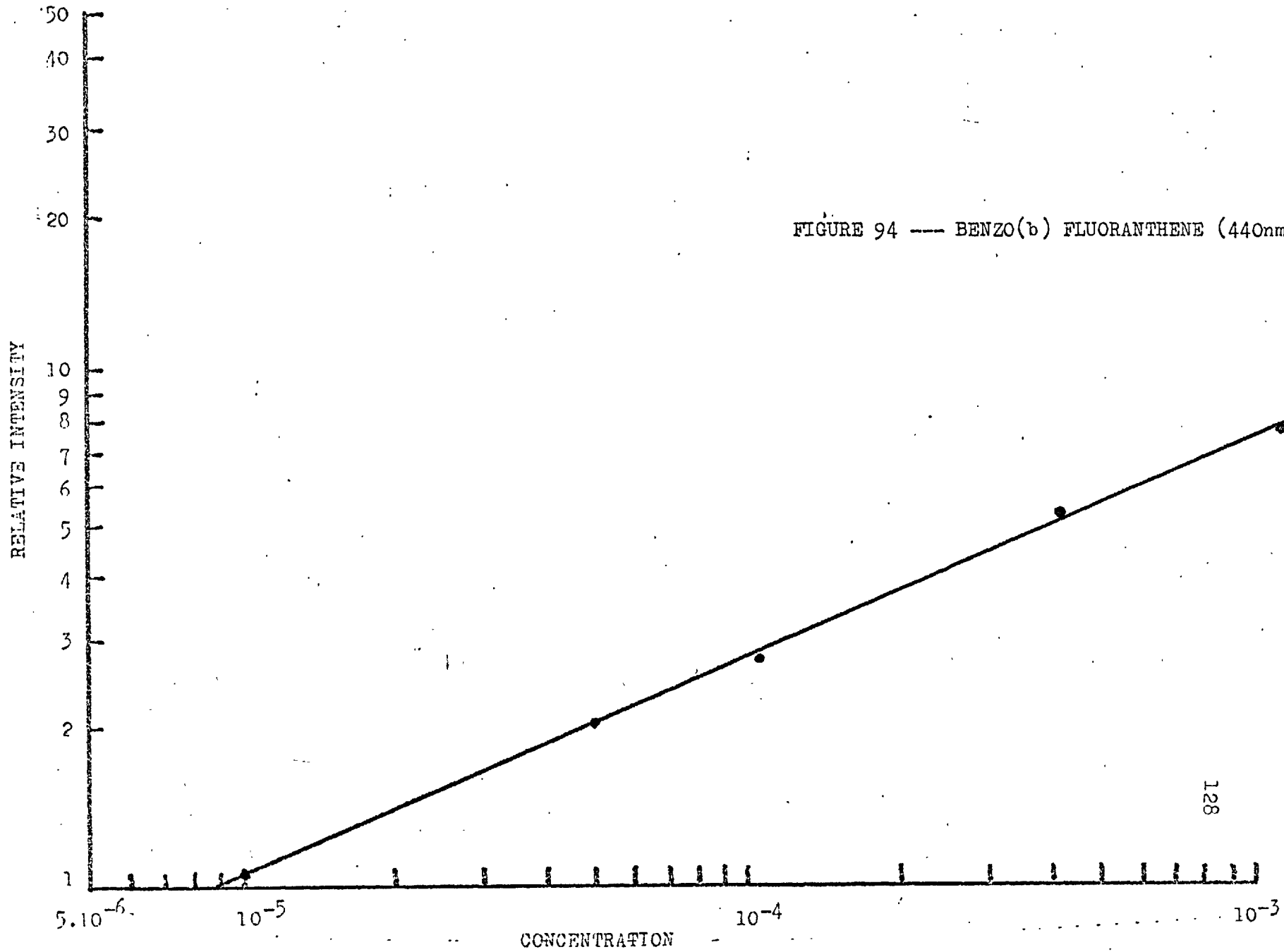
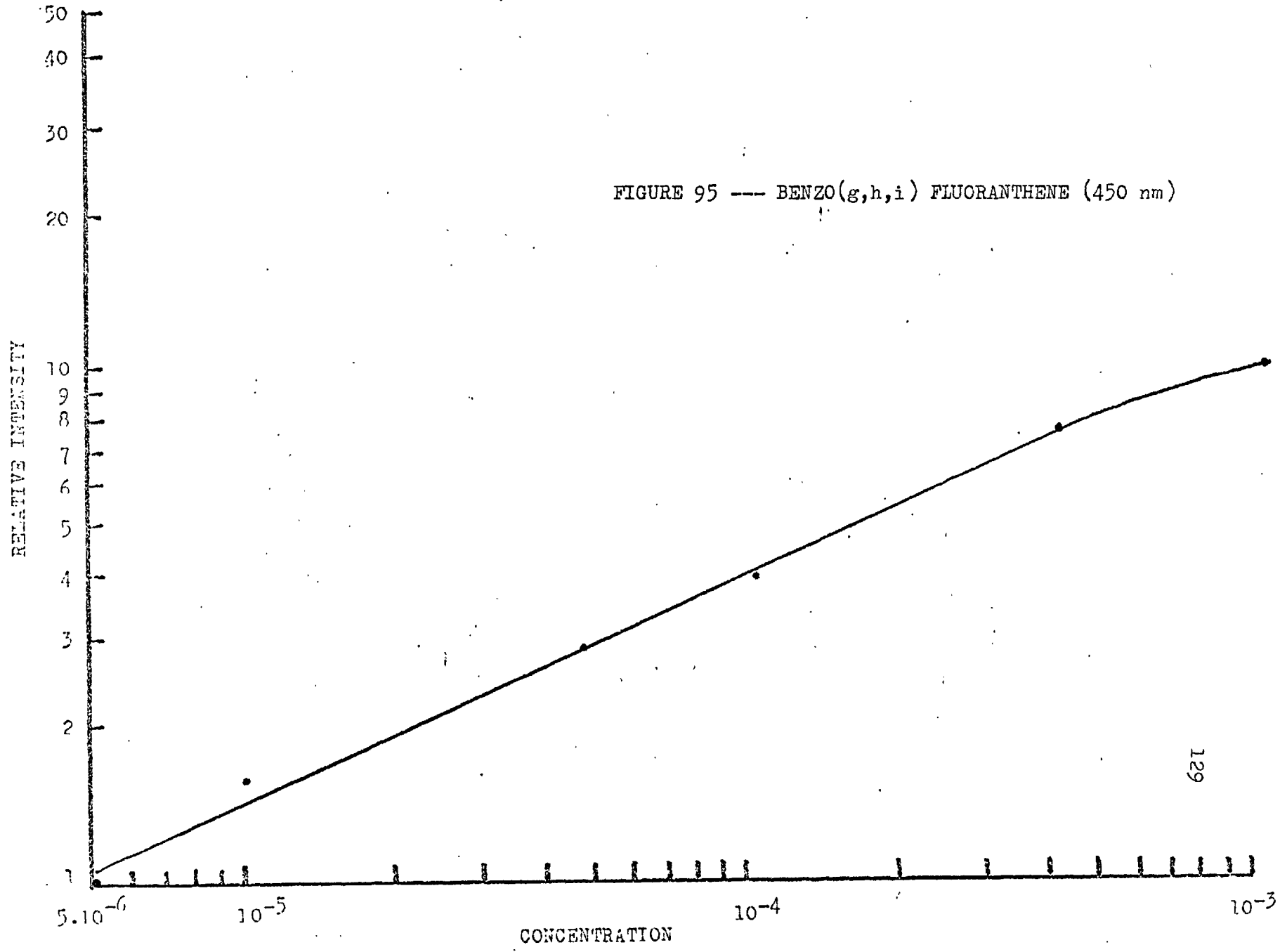
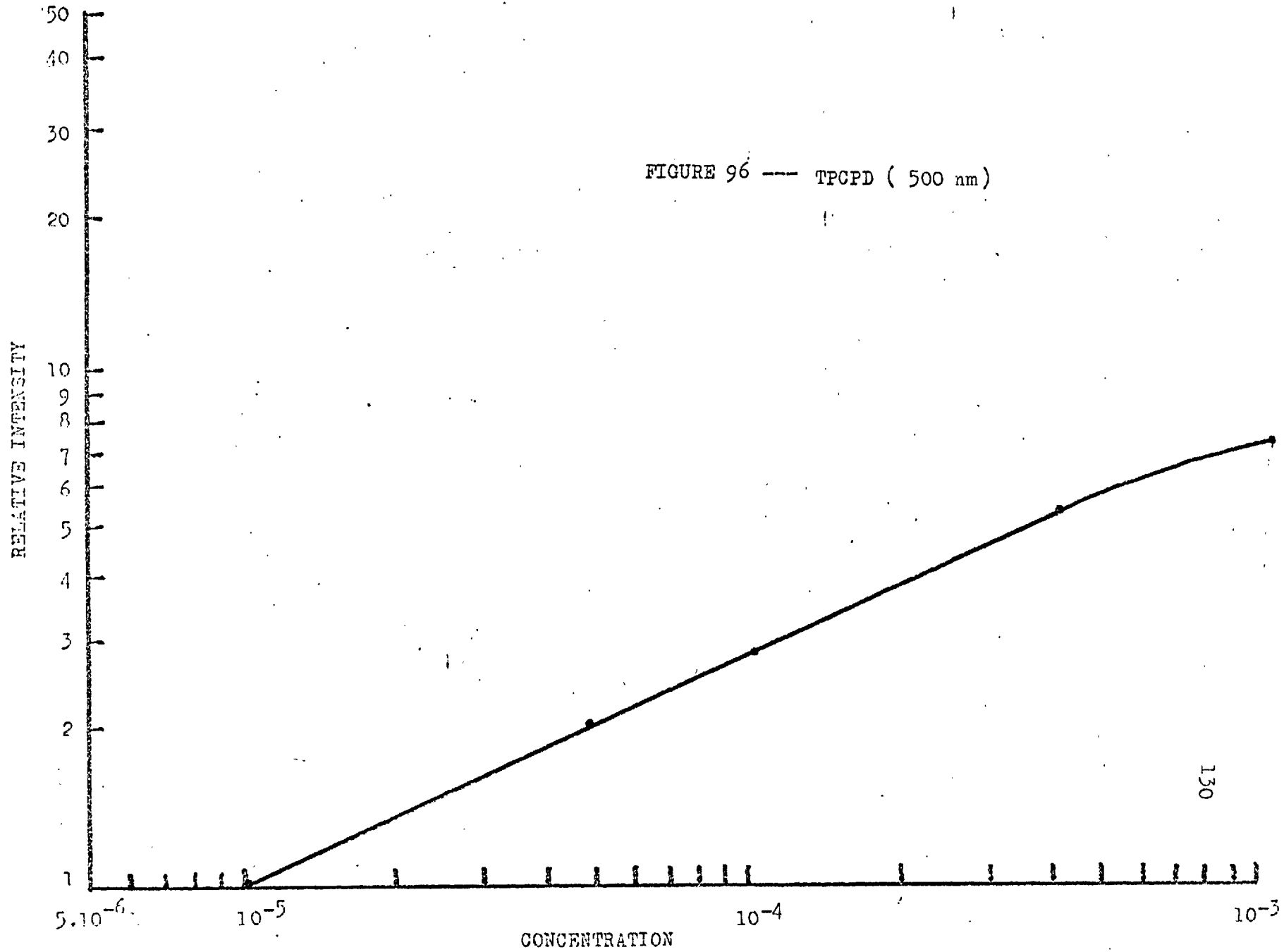
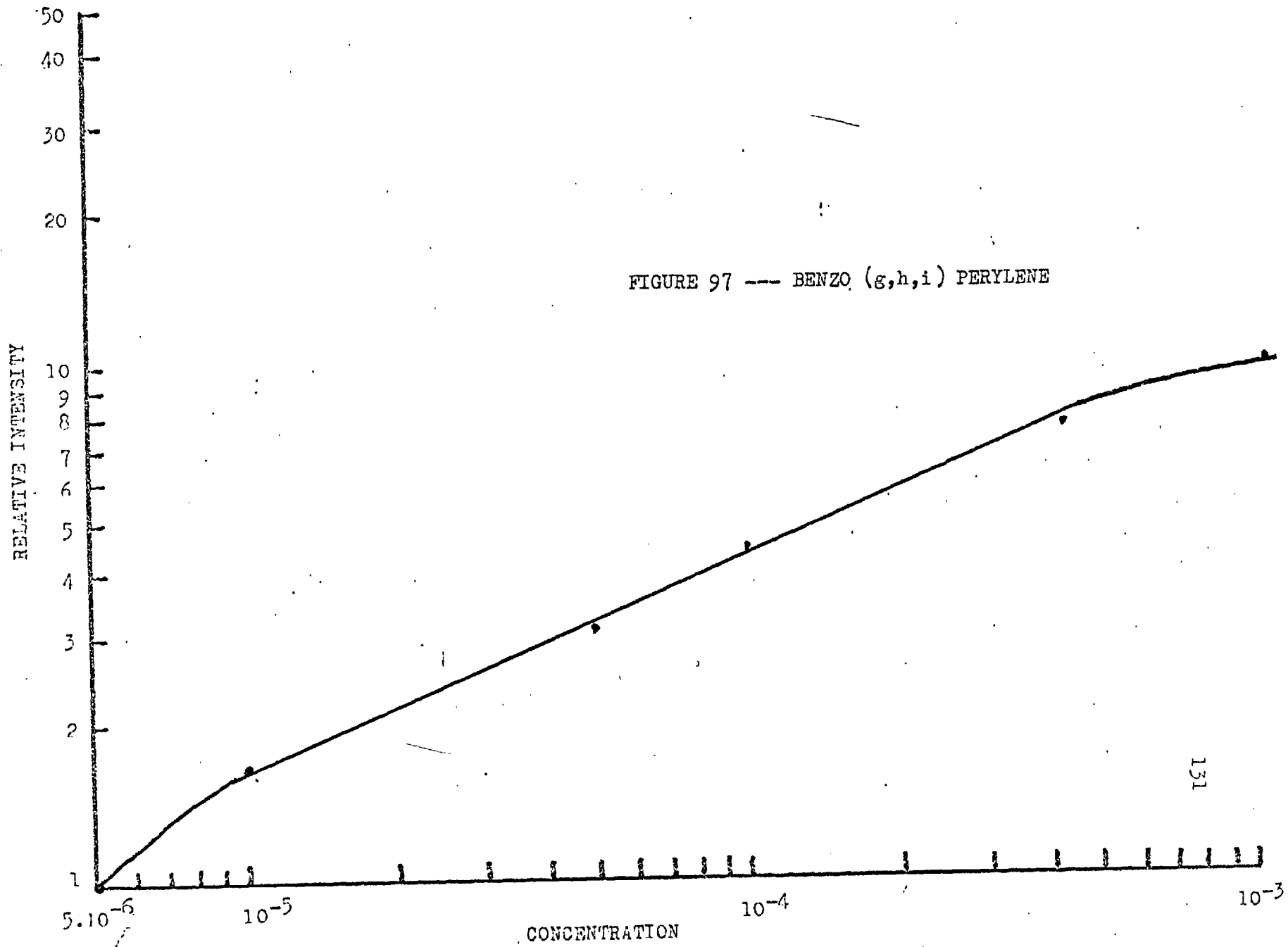
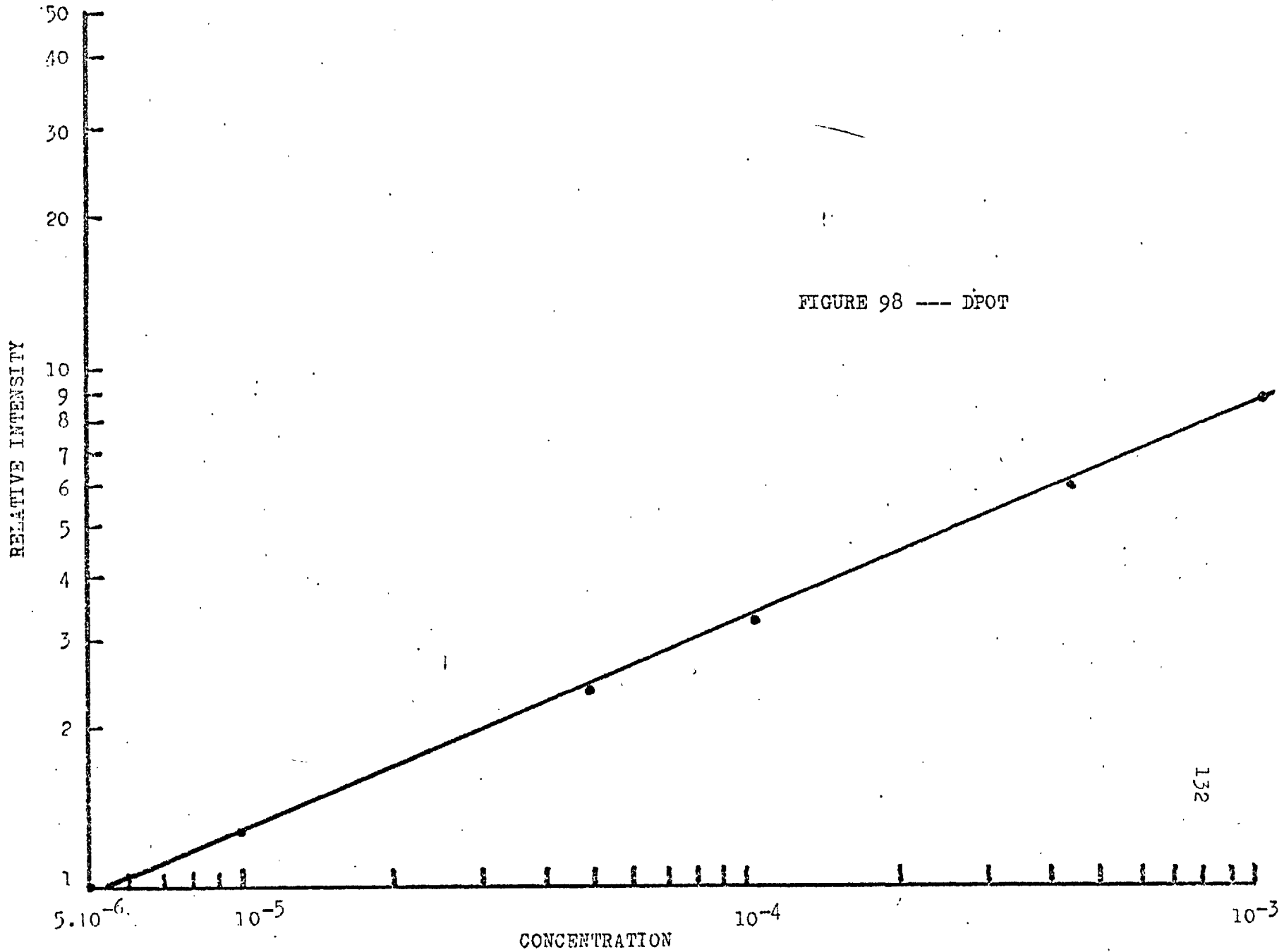

FIGURE 95 --- BENZO(g,h,i) FLUORANTHENE (450 nm)









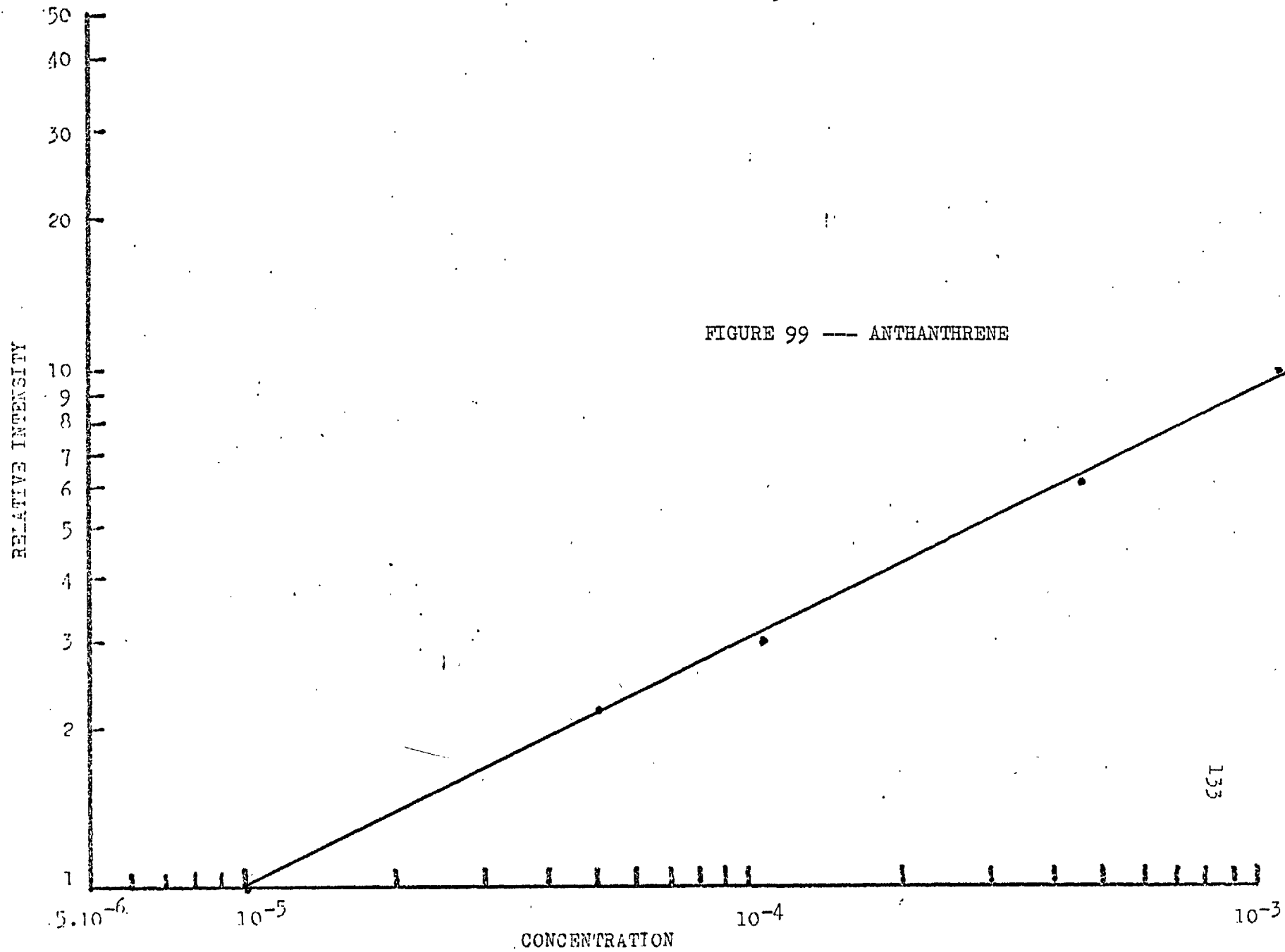

4.3 Electrochemiluminescence of Solution Mixtures

It is possible to distinguish between ECL emission of particular compounds only where there is clear separation, at least 60 nm, of ECL peaks. The situation is further complicated in those cases where new compound formation occurs at relatively low potentials. The spectra of solution mixtures is very dependent upon the applied potential as is shown in Figure 100 for equimolar concentrations of DPA and rubrene. The applied potential of ± 1.6 V does not cause ECL for DPA. At higher potentials (± 3.0 V) emission from each compound can clearly be seen. At potentials above 3.0 V there is some increase in intensity but no significant change in the spectrum from that at 3.0 V. With a tenfold difference in concentration, however, ECL from DPA can clearly be seen at ± 1.6 V (Figure 100 C). Increasing the potential to 3.0 V alters the shape of the spectrum to that shown in Figure 100 D.

The same type of behaviour was also noted for mixtures of DPA and rubicene. The spectra of various solutions of DPA and rubicene are shown in Figure 101.

It was not found possible to distinguish between ECL for a mixture of anthanthrene (ECL max = 540 nm) and DPA. Figure 102 shows the effect of wave-form on a fivefold excess of anthanthrene over DPA under the most ideal conditions of sweep rate and applied potential. The ECL peak in all cases is at 460 nm. Figure 103 shows the effect of concentration on the anthanthrene-rubicene emission spectrum.

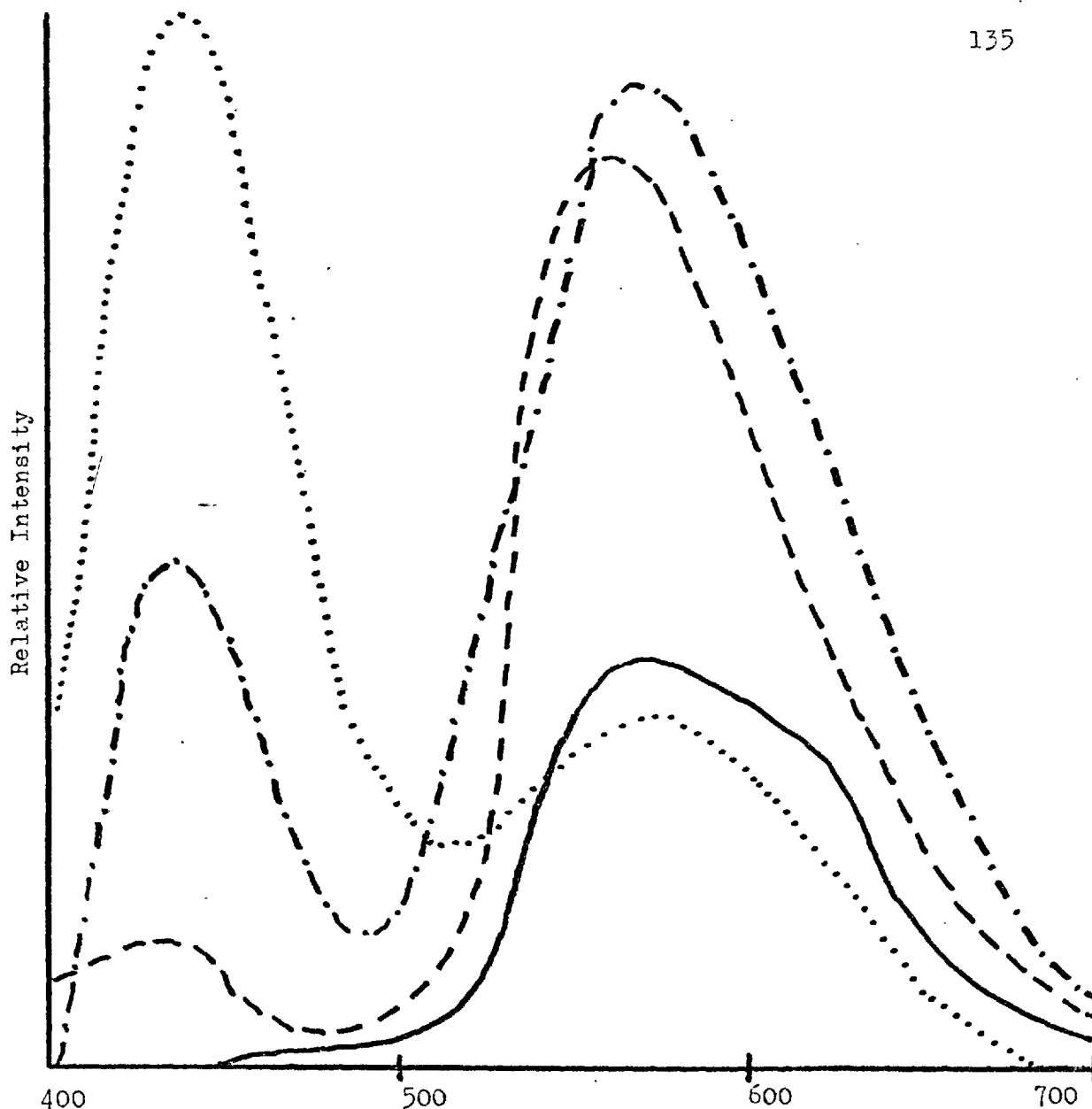

FIGURE 100

Effect of potential on ECL spectra of DPA and rubrene. Sweep rate 30 Hz, square wave. A) 10^{-3} M DPA + 10^{-3} M rubrene, 1.6 V;

B) 10^{-3} M DPA + 10^{-3} M rubrene, 3.0 V;

C) 10^{-3} M DPA + 10^{-4} M rubrene, 1.6 V;

D) 10^{-3} M DPA + 10^{-4} M rubrene, 3.0 V.

Attenuation: A and C = 1; B and D = 10.

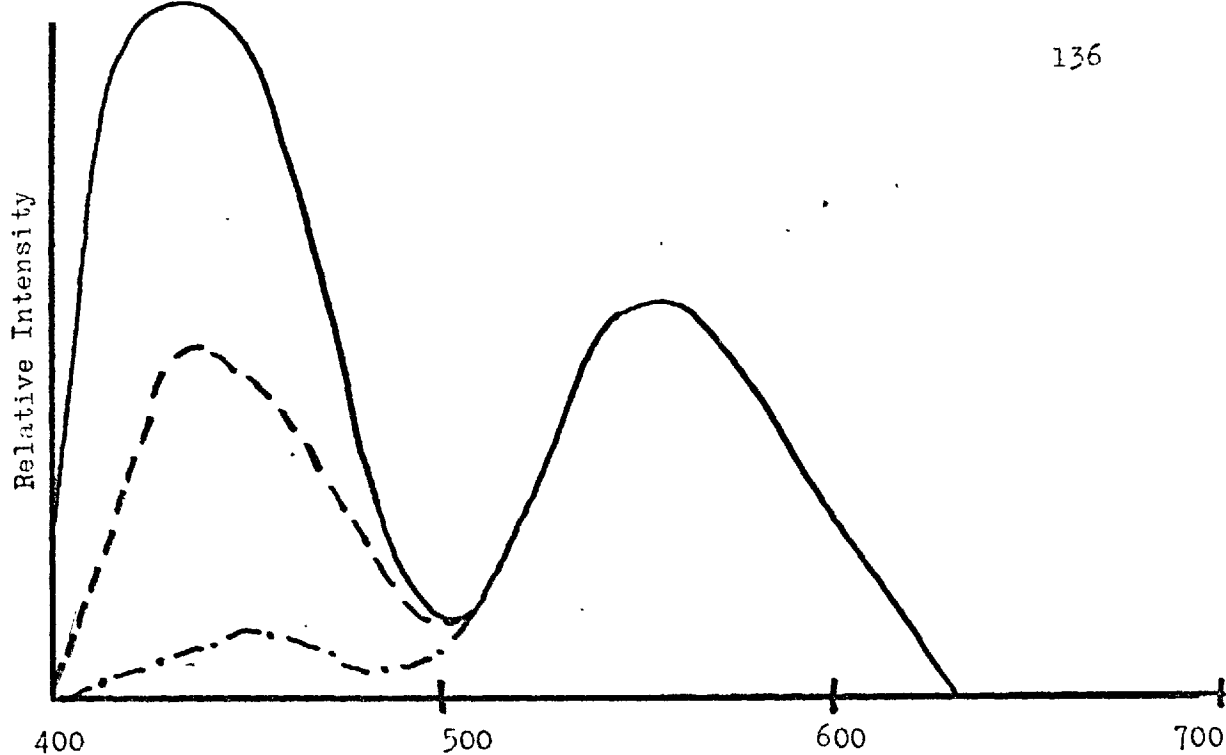

FIGURE 101

Effect of concentration on DPA-Rubicene emission spectrum. 30 Hz square wave, ± 3.0 V. 10^{-3} M rubicene + A) 10^{-3} B) 10^{-4} C) 10^{-5} M DPA

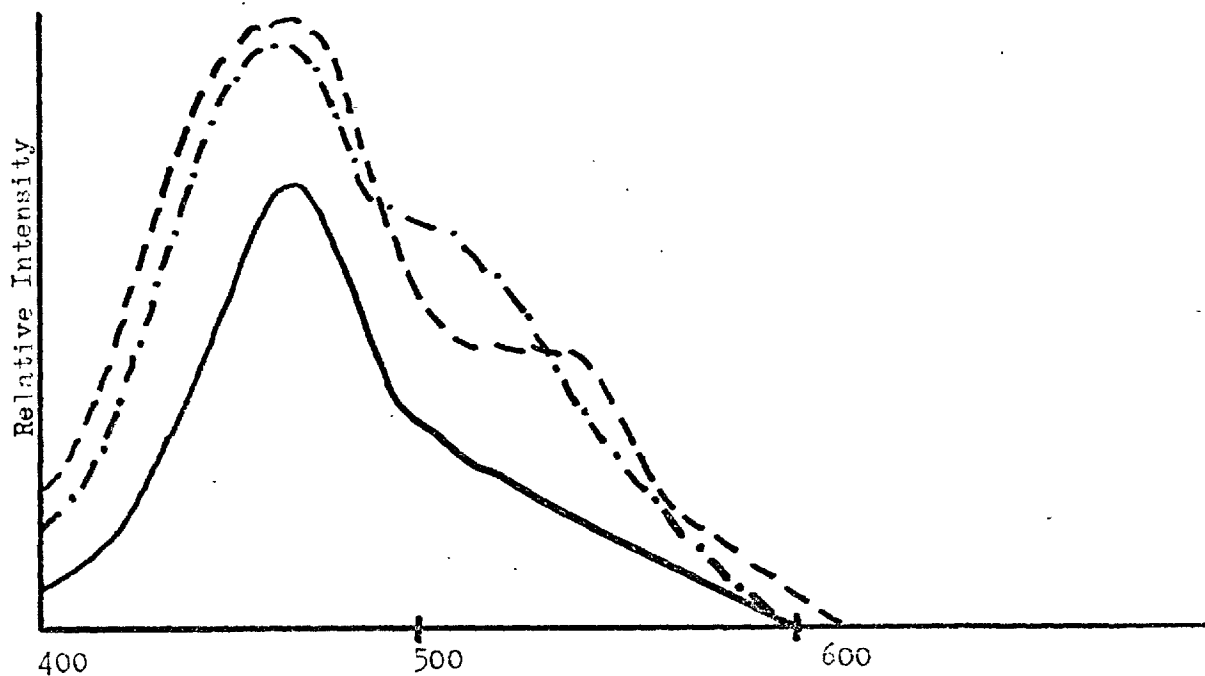

FIGURE 102

Effect of waveform on a mixture of 10^{-4} M DPA and $5 \cdot 10^{-4}$ M anthanthrene. Sweep rate 5 Hz, ± 2.4 V. A) triangular wave; B) square wave; C) sine wave. Attenuation: A = 1; B = 10; C = 4.

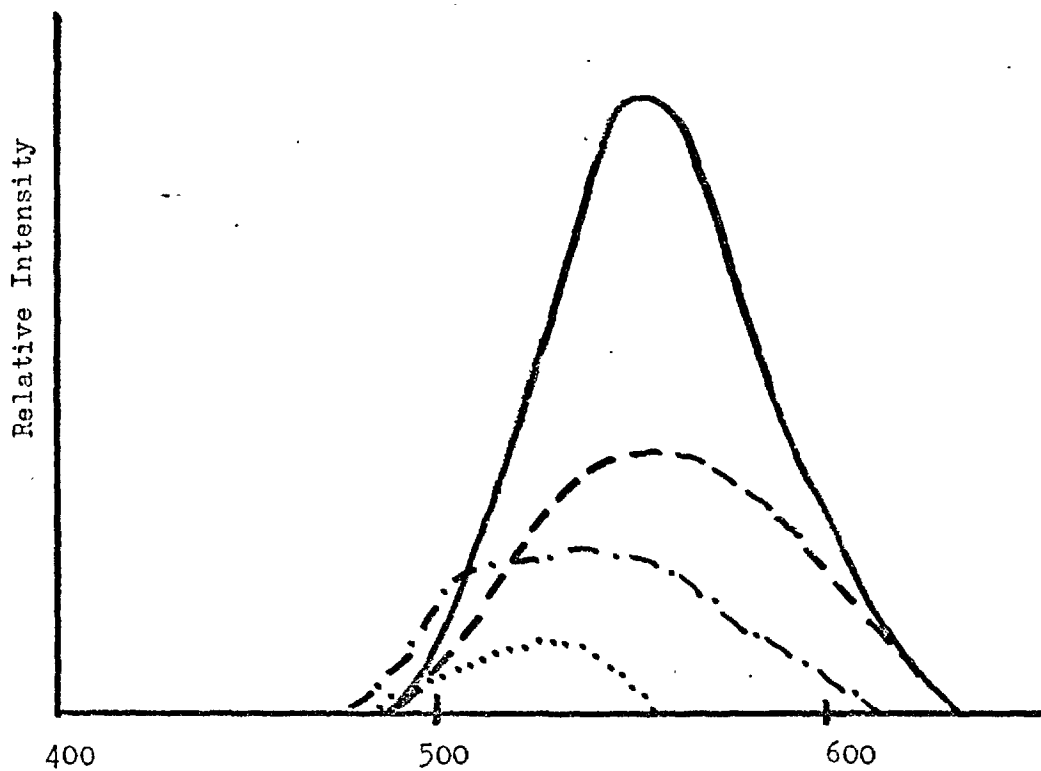

FIGURE 103

Effect of concentration on the anthanthrene-rubicene emission spectrum. 30 Hz square wave, 3.5 V. 10^{-3} M anthanthrene +

- A) 10^{-3} M rubicene
- B) 10^{-4} M rubicene
- C) 10^{-5} M rubicene
- D) no rubicene.

Figure 103 shows that rubicene emission predominates in equimolar cases and even in the case where there is a tenfold excess of anthanthrene. It is therefore not possible to distinguish them in a mixture. By contrast, it is very easy to distinguish anthanthrene fluorescence from rubicene fluorescence in a mixture. The above remarks and general characteristics were also found to be true for anthanthrene-rubrene solutions. A similar study was made for various solutions of DPA and o-phenylene pyrene. DPA is a much stronger ECL emitter; however, when there is a large excess of o-phenylene pyrene (OPP) emission from the OPP can clearly be seen. ECL emission can be distinguished in this case which is particularly advantageous since the fluorescence emission spectra for DPA and OPP are very similar. Results in this instance are shown in Figure 104. Figure 105 shows the effect of sweep rate on the emission for a tenfold excess of OPP. In cases of this sort, ECL, under carefully controlled conditions, can provide a method to distinguish between particular compounds.

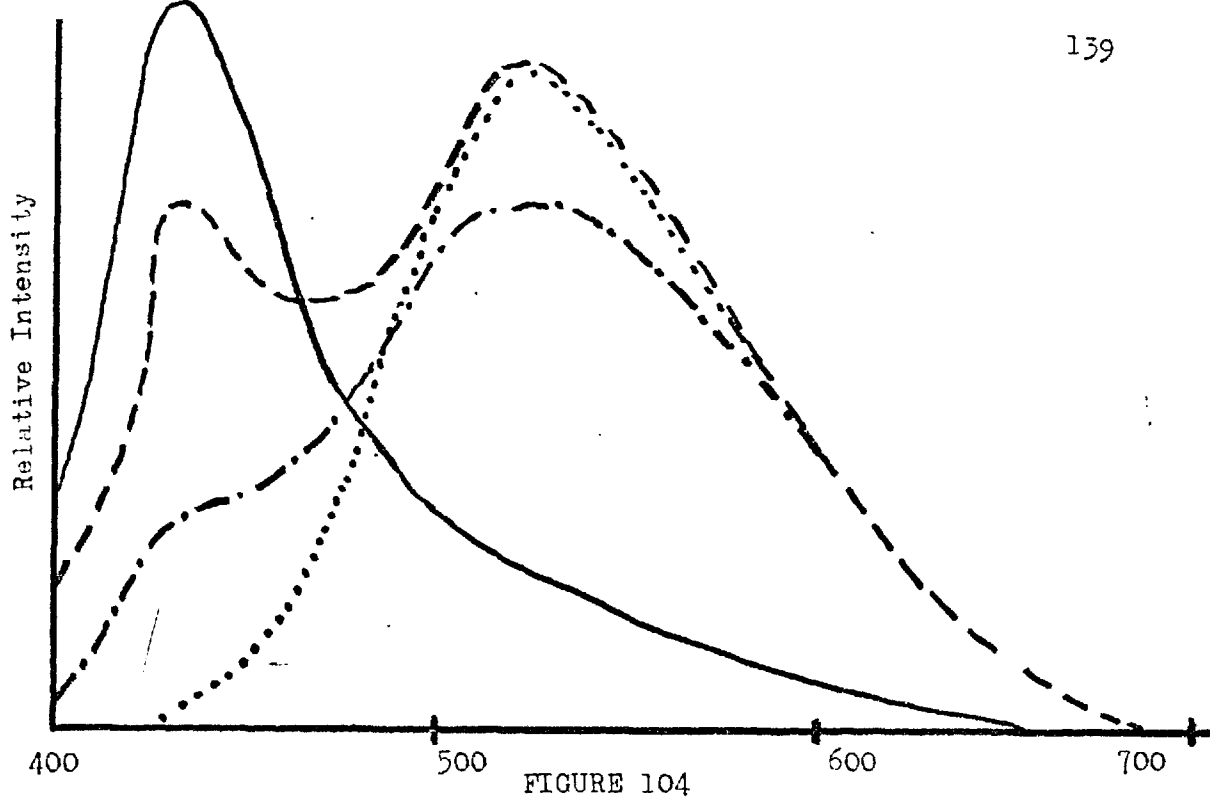

FIGURE 104

Effect of concentration on DPA-OPP system. 30 Hz square wave, ± 3.0 V.
 10^{-3} M OPP + A) 10^{-3} B) 10^{-4} C) 10^{-5} D) 10^{-6} M DPA.

Attenuation: A = 2; B-D = 1.

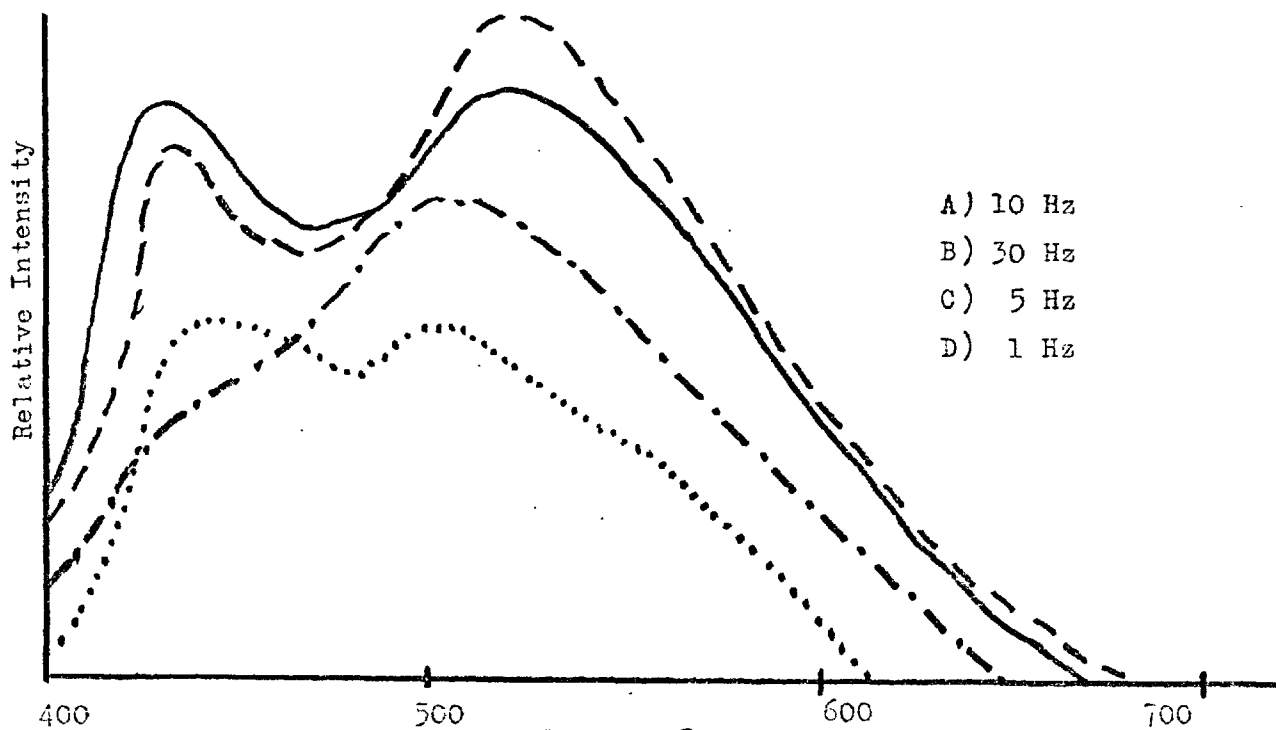

FIGURE 105

Effect of sweep rate on 10^{-3} M OPP- 10^{-4} M DPA. ± 3.0 V.

- A) 10 Hz
- B) 30 Hz
- C) 5 Hz
- D) 1 Hz

CHAPTER FIVECONCLUSIONS AND SUGGESTIONS FOR FUTURE WORK

ECL is a common phenomenon for polynuclear aromatic hydrocarbons and any compound of this type would be expected to show ECL. There is a great variation of intensity from compound to compound, however, and this is sometimes difficult to explain. For example, OPP (Figure 68, page 103) is a strong ECL emitter, yet perflanthene (Figure 67, page 103) was found to be a relatively weak ECL emitter only at relatively high potentials, above 4 V. In view of their similar structures, it is possible that the difference is due to the differences in stability of a radical ion.

The most useful analytical possibility for ECL would seem to be in the comparison of ECL spectra for known compounds with ECL spectra for unknown substances separated from complex mixtures. Even if absolute identification were not possible, strong ECL would indicate that the unknown was most probably a polynuclear aromatic hydrocarbon as opposed to a compound with a large number of substituent groups. The concentration-intensity relationships are only valid in pure solution or in certain cases where other substances are known and do not interfere and it is necessary to carefully define all parameters. For these reasons, use of ECL for this purpose would present no advantages over quantitative determination by fluorescence.

There are clearly some cases where identification of particular compounds is possible but these are relatively rare. Consideration of Figures 35-86 shows that most compounds emit in the same broad region of the spectrum. For many cases where there are solution mixtures, identification of a particular component by fluorescence is easier since the additional variable of choice of exciting wavelength is available.

A great deal of work remains to be done on the mechanisms of ECL which seem to vary from compound to compound. In the case of compounds where new product formation is indicated, identification of these compounds would be very useful. The construction of an apparatus to allow simultaneous monitoring of ECL under very carefully controlled conditions, fluorescence, and change in the absorption spectra of the solutions would also be useful.

As DPOT is a strong ECL emitter, it would seem that related compounds such as 1,6-diphenylhexatriene should also show ECL. Compounds of this type could be studied.

REFERENCES

1. C. Ellis and A.A. Wells,
The Chemical Action of Ultraviolet Rays
Reinhold, New York (1941) and references contained within.
2. W.D. Bancroft and H.B. Weiser,
J. Phys. Chem., 18 (1914) 762
3. N. Harvey
J. Phys. Chem., 33 (1929) 1456
4. R.T. Dufford, D. Nightingale, and L.W. Gaddum
J. Amer. Chem. Soc., 49 (1927) 1858
5. V.Ya. Shlyapintokh, L.M. Postnikov, K.O. Karpuklin, and
A.Ya. Vertil'nyi,
Zh. Fiz. Khim., 37 (1963) 2374
6. D.M. Hercules
Science, 143 (1964) 808
7. R.E. Visco and E.A. Chandross
J. Amer. Chem. Soc., 86 (1966) 5350
8. C.A. Parker and C.G. Hatchard
J. Phys. Chem., 66 (1962) 2506
9. C.A. Parker
Photoluminescence of Solutions
Elsevier, Amsterdam (1968)
10. D.M. Hercules, R.C. Lansbury, and D.K. Roe
J. Amer. Chem. Soc., 88 (1966) 4578
11. A.J. Bard, K.S.V. Santhanam, S.A. Cruser, and L.R. Faulkner,
Fluorescence, G. Guilbault, Ed. (1968) Marcel Dekker, New York
12. A. Zweig,
Advances in Photochemistry, Vol. 6, W. Albert Noyes, Jr.,
George S. Hammon, and J.N. Pitts, Jr., Ed., Interscience (1968)
13. M.E. Peover,
Electroanalytical Chemistry, Vol 2, A.J. Bard, Ed.
Marcel Dekker, New York (1967)

14. T.A. Gough and M.E. Peover
Polarography 1964, Vol. 2, G.J. Hills, Ed.
Macmillan, London (1966)
15. K.S.V. Santhanam and A.J. Bard
J. Amer. Chem. Soc., 87 (1965) 139
16. Chemiluminescent Materials
Technical Report No. 5 to Office of Naval Research and the
Advanced Research Projects Agency, (1964)
As reported in References 11 and 12
17. E.A. Chandross and F. Sonntag
J. Amer. Chem. Soc., 88 (1966) 1089
18. J.N. Bader and T. Kuwana
J. Electroanal. Chem., 10 (1965) 104
19. Y. Anges and R. Signore,
C.R. Acad. Sci., Paris, Ser. A,B 266B (1968) 870
20. D.L. Maricle and A.H. Maurer
J. Amer. Chem. Soc., 89 (1967) 188
21. A.J. Bard,
private communication
22. G.J. Hoijtink,
Faraday Dis. Newcastle (1967)
23. E.A. Chandross, J.W. Longworth, and R.E. Visco,
J. Amer. Chem. Soc., 87 (1965) 3259
24. T. Forster and K. Kasper
Z. Electrochem., 59 (1955) 977
25. J.B. Birks and L.G. Christophorou
Spectrochim. Acta, 19 (1963) 401
26. B. Stevens and E. Hutton
Nature, 186 (1960) 1045
27. B. Stevens
Spectrochim. Acta, 18 (1962) 439

28. C.A. Parker and G.D. Short
Trans. Farad. Soc., 63 (1967) 2618
29. A. Zweig, D.L. Maricle, J.S. Brinen, and A.H. Maurer,
J. Amer. Chem. Soc., 89 (1967) 473
30. A. Zweig, A.K. Hoffmann, D.L. Maricle, and A.H. Maurer,
Chem. Comm., (1967) 106
31. A. Zweig and D.L. Maricle,
J. Phys. Chem., 72 (1968) 377
32. E.A. Chandross and R.E. Visco,
J. Phys. Chem., 72 (1968) 378
33. C.A. Parker and G.D. Short,
J. Phys. Chem., 72 (1968) 3071
34. L.R. Faulkner and A.J. Bard,
J. Amer. Chem. Soc., 90 (1968) 6284
35. A. Zweig, A. Maurer, and B. Roberts
J. Org. Chem., 32 (1967) 1322
36. D.L. Maricle, A. Zweig, A.H. Maurer, and J.S. Brinen
Electrochim. Acta, 13 (1968) 1209
37. R.A. Marcus,
J. Chem. Phys., 43 (1965) 2654
38. M.E. Peover
Electrochim. Acta, 13 (1968) 1217
(Discussion Section following Reference 36)
39. R.E. Visco and E.A. Chandross
Electrochim. Acta, 13 (1968) 1187
40. S.W. Feldberg,
J. Amer. Chem. Soc., 88 (1966) 390
41. S.W. Feldberg,
J. Phys. Chem., 70 (1966) 3928
42. D.M. Hercules and F.E. Lytle,
J. Amer. Chem. Soc., 88 (1966) 4745

43. J. Chang, D.M. Hercules, and D.K. Roe,
Electrochim. Acta, 13 (1968) 1197
44. J.T. Maloy, K.B. Prater, and A.J. Bard,
J. Phys. Chem., 72 (1968) 4348
45. A. Weller and K. Zachariasse,
J. Chem. Phys., 46 (1967) 1984
46. L.R. Faulkner and A.J. Bard,
J. Amer. Chem. Soc., 91 (1969) 209
47. R.L. Stedman,
Chem. Revs., 68 (1968) 153
48. V.M. Bobr, Yu.P. Kozlov, and G.E. Mikhailovskii,
Dokl. Acad. Nauk, SSSR, 175 (1967) 1159
49. E. Clar,
Polycyclic Hydrocarbons
Academic Press, London (1964)
50. C.R. de la 18e Conference IUPAC,
Zurich, 20-28 July, 1955
51. IUPAC, Volume 82. Definitive Rules for Nomenclature
of Organic Chemistry, pp 5553-5557.
52. R. Signore, Vu.T. Han, and R. Zimmermann,
C.R. Acad. Sci., Paris, Ser. A,B 268B (1969) 571
53. R. Signore,
C.R. Acad. Sci., Paris, Ser. A,B 268B (1969) 268
54. G. Viswanath and M. Kasha,
J. Chem. Phys., 24 (1956) 574
55. C.N. Reilley,
J. Chem. Educ., 39 (1962) A853, A933
56. Symposium on Operational Amplifiers in Analytical
Instrumentation, Anal. Chem., 35 (1963) 1770
57. W.M. Schwarz and I. Shain
Anal. Chem., 35 (1963) 1770

58. S. Wawzonek and H.A. Laitinen,
J. Amer. Chem. Soc., 64 (1942) 1765, 2365
59. G.J. Hoijtink, J. van Schooten, E. de Boer, and W.Y. Aalbers-
berg,
Rec. Trav. Chim., 73 (1954) 355
60. G.J. Hoijtink,
Belg. Chem. Indus., 28 (1963) 1371
61. I. Bergman,
Polarography 1964, Vol. 2, G.J. Hills, Ed.
Macmillan, London (1966)
62. I. Bergman,
Trans. Farad. Soc., 50 (1954) 829
63. I. Bergman,
Trans. Farad. Soc., 52 (1956) 690
64. R.S. Nicholson and I. Shain,
Anal. Chem., 36 (1964) 706
65. R.S. Nicholson and I. Shain,
Anal. Chem., 37 (1965) 1351
66. J.E.B. Randles,
Trans. Farad. Soc., 44 (1948) 327
67. A. Sevcik,
Coll. Czech. Chem. Comm., 13 (1948) 349
68. S.A. Cruser and A.J. Bard,
J. Amer. Chem. Soc., 91 (1969) 267
69. W.J. McCarthy and J.D. Winefordner,
Fluorescence, G. Guilbault, Ed.
Marcel Dekker, New York (1968)
70. H. Elmenhorst and G. Reckzeh,
Beitr. Tabakforsch., 2 (1964) 180
71. C.I. Ayres and R.E. Thornton,
Beitr. Tabakforsch., 3 (1965) 285
72. C.I. Ayres and R.E. Thornton,
19th Tobacco Chemists Conf. Lexington, Ky. (1965)

PUBLICATIONS

1. Electrochemiluminescence of Solution Mixtures I.
Spectroscopy Letters 2 (1969) 133

2. Determination of Aliphatic Aldehydes via Polarography of
Their Girard T Derivatives
Analyst, in press

3. Some Observations on the Analytical Utility of Electro-
chemiluminescence for the Determination of Trace Amounts
of Aromatic Hydrocarbons
Analyst, in press

4. Electrochemiluminescence of Solution Mixtures II.
In preparation.