

Adaptive Multi-Channel Transmission Power Control for Industrial Wireless Instrumentation

Waqas Ikram, *Member, IEEE*, Stig Petersen, *Senior Member, IEEE*, Pål Orten, and
Nina F. Thornhill, *Senior Member, IEEE*

Abstract—The adoption of wireless technology for industrial wireless instrumentation requires high-quality communication performance. The use of transmission power control (TPC) can help address industrial issues concerning energy consumption, interference, and fading. This paper presents a TPC algorithm designed for industrial applications based on theoretical and empirical studies. It is shown that the proposed algorithm adapts to variations in link quality, and is hardware-independent and practical.

Index Terms—Adaptive multi-channel transmission power control (AMC-TPC), IEEE 802.11, IEEE 802.15.4, ISA 100.11a, packet reception rate (PRR), received signal strength indicator (RSSI), signal-to-interference-and-noise ratio (SINR), signal-to-noise ratio (SNR), transmission power control (TPC), WirelessHART, wireless sensor network (WSN).

I. INTRODUCTION

THE INDUSTRIAL wireless standards of WirelessHART (a trademark from Hart Communication Foundation), ISA100.11a, and Wireless networks for Industrial Automation-Process Automation (WIA-PA) [1]–[3] underpin the use of wireless technology in the process industries for monitoring and noncritical control applications in oil and gas installations, refineries, and chemical plants. Considerations in industrial wireless networks include RF interference and the constraints of low-power industrial sensor nodes [4], [5]. Process automation applications require frequent periodic communication, which increases power usage.

Resources in a wireless network are limited and are subjected to regulations which mandate the need for efficient spectrum management. Efficient utilization of radio resources is up to the radio resource management (RRM) strategy and one such radio resource is transmission power level. Transmission power control (TPC) involves the adjustment of transmission power at the

transmitting node to the minimum level which can ensure successful communication and maintain a given quality of service (QoS) [6].

One approach to TPC is to adjust the transmission power levels optimally during network design, taking account of the topology of the network [7]. In addition, TPC algorithms can adjust transmission power dynamically to reduce energy consumption of a mobile terminal and prolong its battery life, to minimize co-channel interference in a shared medium, to achieve higher average spectral efficiency, and to address the fading issue during adverse channel conditions while constraining the bit error rate [8], [9].

TPC is used in wideband code division multiple access (W-CDMA), a channel access technique used in the third generation of cellular technology [10]. The use of TPC is also compulsory for Bluetooth class 1 devices but optional for others [11]. However, although TPC is widely used in these communication technologies, its use in short-range, low-power industrial wireless networks is new and has unique challenges. Support for TPC is included in the industrial wireless standards, [1]–[3], but details of its implementation are not specified. It is, therefore, an avenue of research. Motivations for TPC in industrial application such as process automation include:

- 1) energy savings by reducing transmission power to the minimum required;
- 2) prolonging battery life for fast sampling applications;
- 3) adaptation to continuing improvements in devices, particularly in terms of receiver sensitivity [12];
- 4) spectrum efficiency, topology control, and interference suppression to ensure co-existence [13].

This article proposes an adaptive multi-channel transmission power control (AMC-TPC) algorithm for industrial wireless networks such as WirelessHART, ISA100.11a, or WIA-PA. The main contributions of the paper are identification of the opportunity for AMC-TPC within these industrial wireless standards, systematic analysis of the requirements, and provision of an algorithm for AMC-TPC to work with devices that are compliant with those standards. The algorithm built on empirical studies is shown to be adaptive and it supports multi-channel operation.

Section II reviews the background and context of related work. In Sections III and IV, the system model is presented and the problem is formulated and studied. A new TPC algorithm based on the empirical studies is presented in Section V. The algorithm is then validated experimentally and the results are shown and discussed in Sections VI and VII. Finally, Section VIII highlights the contributions and novelty of the work presented in this paper followed by the conclusion in Section IX.

Manuscript received August 05, 2012; revised April 28, 2013 and October 04, 2013; accepted January 05, 2014. Date of publication March 11, 2014; date of current version May 02, 2014. This work was supported in part by the U.K. Engineering and Physical Sciences Research Council through a Doctoral Training Award and the Industrial Research Chair scheme of the Royal Academy of Engineering, and in part by the WiCon project funded by the Research Council of Norway under Grant 201376/S10. (*Corresponding author: N. F. Thornhill.*) Paper no. TII-13-0066.

W. Ikram was with Imperial College London, London SW7 2AZ, U.K. He is now with ABB Process Automation, Oil, Gas, and Petrochemicals, Oslo, Norway (e-mail: waqas.ikram@no.abb.com).

S. Petersen is with SINTEF ICT, 7465 Trondheim, Norway (e-mail: Stig.Petersen@sintef.no).

P. Orten is with ABB Corporate Research Center, 1375 Billingstad, Norway (e-mail: pal.orten@no.abb.com).

N. F. Thornhill is with the Department of Chemical Engineering, Imperial College London, London SW7 2AZ, U.K. (e-mail: n.thornhill@imperial.ac.uk).

Color versions of one or more of the figures in this paper are available online at <http://ieeexplore.ieee.org>.

Digital Object Identifier 10.1109/TII.2014.2310594

TABLE I
OVERVIEW OF WIRELESS STANDARDS

<p>IEEE 802.15.4: A standard which specifies the physical and medium access layers of a wireless network. It is aimed at applications with low power and low rates of data transmission.</p> <p>Wi-Fi: A certified wireless technology which allows the electronic devices to exchange data using radio waves, and complies with the IEEE 802.11 suite of standards.</p> <p>IEEE 802.11 standard and extensions: A family of standards for wireless local area networks operating in 2.4GHz and 5GHz ISM band.</p>

II. RELATED WORK

TPC has been proposed for wireless networks which include cellular, fixed point-to-point microwave links, Mobile Ad-hoc NETWORKS (MANETs), vehicular ad-hoc networks (VANETs), wireless local area networks (WLANs), and wireless personal area networks (WPANs). TPC in cellular networks has been extensively studied, and many review papers have been published on the subject including [14]. The authors of [14] and [15] consider that TPC will remain a key configurable component in future mobile network to ensure QoS. A common viewpoint is that collectively adapting power, modulation, and channel assignment can enhance throughput and energy use in network operations. However, the TPC strategies and methods for traditional networks cannot simply be replicated for industrial wireless sensor networks (WSNs). Reasons include use of the industrial, scientific, and medical (ISM) radio band; requirements of the industrial wireless standards; network classification and topology; off-the-shelf available transceiver hardware; inherent limitations of wireless sensor nodes; and predefined and fixed parameters such as modulation.

The following sub-sections review some of the relevant literature, which can be classified into three categories: 1) performance limitations of the IEEE 802.15.4 standard; 2) link quality assessment; and 3) TPC algorithms for WSNs. Table I gives an overview of the relevant wireless standards.

A. Performance Limitations of IEEE 802.15.4

Link budget is important for performance because it takes account of all the gains and losses from the transmitter to receiver through the propagation medium. If the received power is near the threshold of the receiver sensitivity, the packet error rate (PER) will rise. The work in [12] highlights the theoretical and practical sensitivity limits of the IEEE 802.15.4 compliant receivers. The investigation by [16] has summarized the impact of signal-to-noise ratio (SNR) on packet loss rate under additive white Gaussian noise and Rayleigh fading models, and further coexistence is studied through simulations in [17]. Empirical evaluation of the IEEE 802.15.4 network is carried out in [18] and has indicated the operational limitations.

Reference [19] highlights the impact of coexisting office Wi-Fi (IEEE 802.11b) networks on the PER of IEEE 802.15.4 networks and gives insights to the effect of interference on the link budget. The above work emphasizes factors affecting the theoretical and practical limits of the underlying physical layer used in industrial wireless standards.

Furthermore, [20] studied the medium access control (MAC) protocol specified by the IEEE802.15.4 standard when power

management is enabled. The results show that the nodes experienced low communication reliability. This unreliability issue was identified to be linked to the carrier sense multiple access with collision avoidance (CSMA/CA)-based algorithm. Even though this is a common issue for all CSMA/CA-based MAC protocols, it is more prominent in the case of IEEE802.15.4 standard when operated with default parameters suggested in the standard. Although [20] showed that in some cases with appropriate parameter settings the reliability can be improved, in certain scenarios the parameters used were not compliant with the standard.

B. Link Quality Assessment

Link quality refers to the communication performance of a radio channel, which changes significantly with time and environment [21]. Received signal strength indicator (RSSI) and link quality indicator (LQI) can be used as link quality metrics [21]–[23]. In [24], the authors conducted experiments to evaluate wireless link quality based on RSSI and LQI by varying distance and transmission power levels. The experiments presented in [22] further investigate the effect of interference on IEEE 802.15.4 receivers by varying transmission power, distance, orientation, packet size, and relative distance from interfering nodes.

The overall findings from the cited work are that in a rapidly changing environment and with limited resources, RSSI is a better indicator of link quality. RSSI is also better defined in the IEEE 802.15.4 standard compared to LQI [25]. The review in [26] highlights that evaluation of LQI is vendor-specific, whereas most transceivers include a RSSI register. The same review paper discusses issues such as nonisotropy and the variability of link assessment in the transitional region. It compares hardware-based link quality measures (RSSI, LQI) and software estimators. Software estimators have higher energy consumption overheads for computation and communication, giving a further reason to use the hardware-based RSSI measurement in a TPC algorithm.

An investigation aimed to study the speed-dependent PER of wireless sensor radios on rotating mechanical structures is presented in [27]. As a result, a predictive PER model for a fast rotating sensor radio channel based on channel impulse response measurements was presented. It takes into consideration power attenuation, bit error rate, received signal strength, and the radio receiver sensitivity.

C. TPC Algorithms

TPC algorithms rely on the availability of a range of transmission levels at the transmitter. The selection criteria for useful power levels within indoor environments are highlighted in [28] for Wi-Fi (IEEE 802.11 b/g) networks. In [29], an adaptive TPC algorithm is proposed where each communicating node builds a model for each of its neighbors, describing the relationship between transmission power and the link quality metric. A linear approximation is assumed between transmission power and RSSI. The authors in [30] have proposed algorithms for TPC based on an analytical model of RSSI. The signal-to-interference-and-noise ratio (SINR) approximation in [30] assumes that

interference is negligible, however. An investigation of the performance of TPC algorithms in terms of PER, power gain, and energy efficiency in additive white Gaussian noise and Rayleigh channels is presented in [31]. The TPC approach in [22] is based on tracking RSSI where the effect of radio channel uncertainty and interference were considered as disturbance. Quantifiable improvements were shown in terms of reduced outage probability and power consumption. The algorithm proposed in [32] utilizes RSSI and LQI at the receiver to adjust the transmission power. It was demonstrated that the proposed methodology yielded good link quality while saving power. In addition, an SINR-based TPC for wireless ad hoc networks is presented in [33]. However, it is studied through simulations and the control messages are transmitted using announcement traffic indication message (ATIM) within IEEE 802.11 distributed coordination function (DCF). Other theoretical or simulated studies include the following.

- 1) The Hybrid [34] is an example of TPC for MAC protocols in WSNs. Its algorithm iterates over available transmission power levels in order to achieve and maintain the target link quality.
- 2) The same authors [34] have also presented another TPC approach referred to as attenuation with exponentially weighted moving average (AEWMA) which utilizes the reception power, noise power, and transmission power in order to determine the ideal transmission power.
- 3) The local mean algorithm (LMA) [35] is proposed for WSNs where the transmitter counts the number of reachable neighbors at a particular power level, where value is adjusted if the received acknowledgments are less than what was expected.
- 4) A modification to LMA is the local mean of neighbors (LMN) algorithm where the receiver adds the number of its neighbor's neighbors to the acknowledgment packet [35], [36] to make the connectivity of its neighbors visible. Using this enhanced information, the transmitter makes power adjustments. This strategy does not require storing of a neighbors' table. It requires fewer resources and is based on number of reachable neighbors.
- 5) Kawadia and Kumar [37] have investigated whether TPC is to be implemented in the MAC or routing layer. They take into consideration the energy-efficient routes which incorporate links in a multi-hop network.
- 6) In the real-time power-aware routing (RPAR) protocol presented in [38], the dynamic power adjustment and routing decisions are made in order to minimize the packet loss rate.

In addition, in the case of [39], topology control is studied in relation to power control. A distinction is made between power control approaches based on transmitting power levels available at the nodes, referred to as homogenous- (i.e., all nodes utilize same transmitting power level) and nonhomogeneous (i.e., different individual transmitting power level)-based topology controls.

TPC algorithms for industrial wireless systems are not well developed. Industrial wireless protocols have strict requirements, for instance, time slotted frequency hopping between channels [40]. For an industrial strength TPC, moreover, the

algorithm has to be robust to interference. However, the performance of TPC algorithms is often reported for static channel deployments. In addition, the static channels are often in a different frequency band than a co-habiting Wi-Fi network, in order to avoid degradation due to interference. In an industrial environment, the changing link quality from one channel to the other and the effect of Wi-Fi on some channels compared to others has to be considered. Therefore, a TPC algorithm is required which can adapt to changing radio environment, is quick to respond, works on a pair-wise basis to ensure topology-independency and autonomous operations, and is practical.

III. SYSTEM MODEL

A. Terminology

The following definitions are needed.

- 1) *RSSI*: Received signal strength indicator provides an estimate of the received signal power in the transmission channel [25]. It is the RF power input to the receiver [41], [44] given by

$$\text{RSSI} = 10 \log_{10}(S + I + n), \quad I = \sum_{m=1}^M I_m \quad (1)$$

where S is signal power, I is the total interference power, n is the noise power, and I_m is the interference from interferer number m , and M is the total number of interferers.

- 2) *LQI*: Link quality indicator is a metric of link quality; it may be implemented using receiver energy detection, SNR estimation, or a combination of these methods [29], [42]. The IEEE 802.15.4 standard does not specify how the LQI is to be measured. Some commercially available chips map LQI to SNR [43].
- 3) *PRR*: Packet reception rate is the time average of the ratio of number of received packets to those transmitted. It is a metric of link quality [24].
- 4) *SNR*: It is the ratio of strength of desired signal to noise. It is expressed as follows [44]:

$$\text{SNR} = 10 \log_{10}(S/n). \quad (2)$$

- 5) *SINR*: It is the ratio of desired signal to interference plus noise. It is given by [44]

$$\text{SINR} = 10 \log_{10}(S/(I + n)). \quad (3)$$

B. Requirements Analysis

The topology of an industrial wireless network is typically a simple star topology, but may also be a multi-hop mesh network. WirelessHART supports frequency hopping on per packet basis (fast hopping), while ISA100.11a supports both slow and fast hopping [2]. Generally, the TPC algorithm will need to operate over all the available channels, a maximum of 16 in the 2.4-GHz band. Each node will have its neighbor's information such as its unique identification number, allocated time slot, and channel number stored in communication tables. For each neighbor and for all available communication channels, a set of minimum

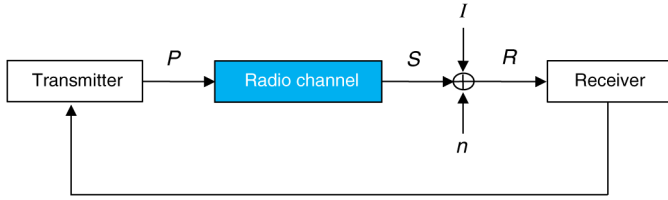

Fig. 1. TPC loop, after [22], [30].

transmission power levels has to be estimated to ensure an adequate SINR.

The requirement for TPC is to estimate minimum transmission power level while ensuring:

- 1) minimum overhead linked to TPC;
- 2) adaptation to all channels and changing conditions;
- 3) prevention of outages;
- 4) independence of hardware platform;
- 5) adaptability to asymmetric links, varying transmission power levels and sensitivity thresholds of the receiver.

C. Problem Formulation

Fig. 1 depicts a generic control loop for TPC. To the left of the figure is a transmitter operating at a transmission power level of P , the RSSI value received by the receiver on the right is represented by R . The block labeled *Radio Channel* represents the signal attenuation as it propagates.

The attenuation between transmission power P and signal power S depends on path loss and other properties of the channel such as shadowing. The signal is then subjected to interference and noise, and the final value is R , reported as RSSI by the receiver. Interference between co-existing wireless networks has to be taken into account [19], [45]. Based on the work from [19], it was found that an IEEE 802.15.4 network experiences performance degradation if operated within 7 MHz of Wi-Fi (802.11b) channel and within a vicinity of 8 m, so the PRR and RSSI values will vary from channel to channel. These explanations show that higher values of RSSI in some channels may be attributed to interference, whereas channels without interference may have a lower value. The corresponding SINR will vary. Therefore, SINR estimation is important to ensure a specific threshold throughout the channels [16], [30].

1) *SINR and SNR Estimation*: In many cases, the main source of interference is a co-existing Wi-Fi network. The IEEE 802.15.4 channels whose frequencies overlap with the Wi-Fi network are referred to as in-band channels and those which do not overlap are called out-of-band channels. The use of Wi-Fi is often limited to three channels as adjacent Wi-Fi channels in the 2.4-GHz band overlap. This simplifies the process of identifying in-band and out-of-band channels. The amount of interference caused to in-band channels by a Wi-Fi network will depend on network traffic. However, beacons are broadcast at regular intervals by a Wi-Fi network and will result in a constant source of interference. Empirical data can be used to estimate the SINR and SNR. The equation for RSSI (1) can be used to obtain the approximation presented in (4), given that there is no interference. Here IB represents in-band and Si represents Signal. A bar above, e.g., $\overline{\text{IB}}$ means an out-of-band channel which is not

TABLE II
DETAILS OF THE HARDWARE USED

CC2430EM : A system which incorporates a microcontroller and a transceiver based on the CC2420 radio.
CC2420 : A wireless transceiver which complies with the IEEE 802.15.4 standard.
SmartRF04EB : An interface board used for programming, evaluation and connecting the CC2430 module to a computer.
These are Chipcon products available from Texas Instruments.

affected by interference. Further, as the IEEE 802.15.4 compliant devices provide a mechanism to perform clear channel assessment (CCA), they can be used to detect the energy present in a channel [43]. Without signal transmissions (i.e., $\overline{S_i}$), in-band assessment results in (5), and out-of-band is represented by (6). Here, the channel energy indicator (CEI) is used instead of RSSI, because RSSI is associated with the signal. In the absence of a signal, channel energy can still be quantified. Therefore, CCA modes along with RSSI can be used to obtain the approximations given below

$$\text{RSSI}_{\overline{\text{IB}},\overline{S_i}} \approx 10 \log_{10}(S + n) \quad (4)$$

$$\text{CEI}_{\overline{\text{IB}},\overline{S_i}} \approx 10 \log_{10}(I + n) \quad (5)$$

$$\text{CEI}_{\overline{\text{IB}},\overline{S_i}} \approx 10 \log_{10}(n). \quad (6)$$

SINR and SNR can be determined from RSSI and CEI. Subtracting (5) from (4) gives an estimate for SINR as follows:

$$\text{SINR}_{\text{estimation}} = 10 \log_{10}(10^{(\Delta\text{RSSI}_i/10)} - 1) \quad (7)$$

where $\Delta\text{RSSI} = \text{RSSI}_{\overline{\text{IB}},\overline{S_i}} - \text{CEI}_{\overline{\text{IB}},\overline{S_i}}$. These values are directly obtained from the receiver. Subtracting (6) from (4) gives an estimate for SNR

$$\text{SNR}_{\text{estimation}} = 10 \log_{10}(10^{(\Delta\text{RSSI}/10)} - 1) \quad (8)$$

where $\Delta\text{RSSI} = \text{RSSI}_{\overline{\text{IB}},\overline{S_i}} - \text{CEI}_{\overline{\text{IB}},\overline{S_i}}$.

These estimates are derived from empirical data, and can be approximated using a PRR test conducted over multiple channels. Periodic sampling of the radio channel in the absence of signal will quantify the noise power. Hardware linked noise power varies with temperature. However, it is quite stable over time periods of seconds or minutes [18]. These estimates along with the RSSI tracking will assist in the formulation of a TPC algorithm.

IV. EMPIRICAL STUDIES

This section describes empirical studies on the performance of wireless links. The purpose was to examine the effect of interference on RSSI values in different channels and to find a reliable way to characterize the distributions of RSSI values. The results are needed to formulate the TPC algorithm for wireless industrial instrumentation.

A. Hardware Implementation

All experiments were conducted using CC2430EM modules which comply with the IEEE 802.15.4 standard. Table II gives

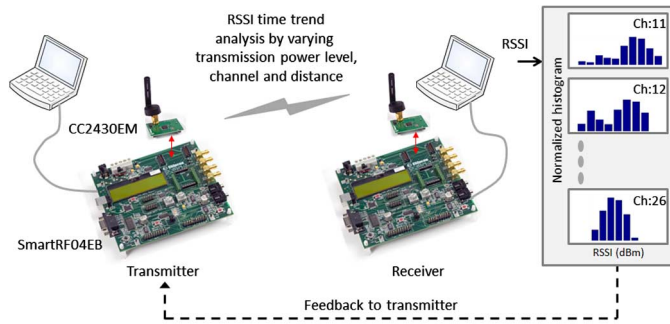

Fig. 2. Experimental setup.

details. The transmission power of the radio transceiver was controlled by adjusting the radio parameters. The CC2420 radio reports a RSSI value on successful reception of a packet at the destination. The routines written to conduct the evaluation test and the network access are all handled by the CC2430EM module. The module was used in conjunction with the SmartRF04EB board which connects it to the computer.

B. Experimental Setup

Fig. 2 shows the experimental setup. The experiments involve the use of CC2430EM modules along with the evaluation board, SmartRF04EB. The boards are connected to a laptop computer where the data are generated and logged in MATLAB using the real-time windows target toolbox. The data generated are the packets to be sent over the wireless link while the corresponding sequence number of the received packet and RSSI values are logged at the receiver. No part of the hardware or radio link is simulated and all the data are experimental values. The use of MATLAB facilitates data generation, logging, and analysis of the radio link performance. In these experiments, some calculations are done in the laptop computer and the rest on the CC2430EM module; however, they could also be executed on the wireless node platform if desired. The packet size used is the maximum supported by the standard, i.e., 127 bytes.

The objective of the experiments was to provide the information needed to optimize the parameters of the TPC algorithm. They also establish that RSSI can give the required estimates of link quality and characterize the distribution of the RSSI measurements when interference is present.

The transmitter was programmed to send 3600 packets with a given transmission power level through a channel to the receiver. For each received packet, the corresponding RSSI was recorded and represented in a distribution. The experiments examined several different channels (12, 15, 18, 24, and 26) at different transmission power levels between -25 and 0 dBm, as illustrated in Fig. 3. The maximum allowed transmission power level in the wireless instrumentation standards is 10 dBm; however, in the radio module used here the maximum allowed transmission power is 0.6 dBm.

C. Results and Performance Analysis

Fig. 3 shows the measured RSSI values for five channels together with linear best-fit lines for channels 15 and 24. Within the same vicinity, there was Wi-Fi activity in channels overlapping with the IEEE 802.15.4 channel 24 which explains why

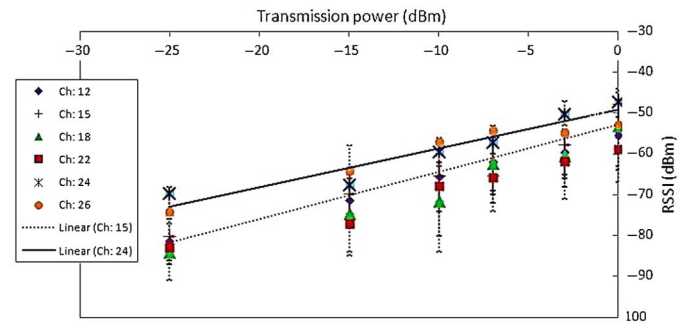

Fig. 3. RSSI distribution versus transmission power.

channel 24 has the highest RSSI values. Fig. 4 shows normalized histograms representing recorded RSSIs in channels 15 and 24. Channel 15 is an out-of-band channel which is not affected by the Wi-Fi interference. Channel 15 follows a Gaussian distribution whereas channel 24 which has Wi-Fi interference has a bimodal distribution.

D. Characterizing RSSIs

The TPC algorithm uses the RSSI distribution. The experimental results in Section IV-C show that the RSSI distributions are not necessarily simple Gaussians and, therefore, the algorithm requires an empirical estimate of the distribution. The proposed TPC algorithm will, therefore, sample RSSI values for a period of time and construct a sampled distribution from the measured values as an estimate of the true distribution.

In order to determine how many packets are needed to estimate the true RSSI distribution, a statistical measure referred to as Kullback–Leibler Divergence (KLD, [46]) is used. It quantifies the difference between two distributions. The KLD is zero when two distributions are identical [46].

The method requires a reference distribution to represent the true distribution of RSSI values. The best empirical approximation to the reference distribution is when a large amount of data has been collected. In this work, the reference distribution was determined from 4000 packets. The estimated RSSI distribution for comparison was then computed using fewer consecutive received packets. For both channels and for line-of-sight and no line-of-sight conditions, the KLD result showed that 1000 packets were adequate for estimation of RSSI in a TCP algorithm.

V. DESIGN OF THE TPC ALGORITHM

The distributed nature of industrial wireless instruments and mesh networking requires a decentralized approach that is vendor independent. Requirements for the TPC algorithm are as follows: 1) it should execute pair-wise between two nodes at a time; and 2) it should track the link quality using RSSI rather than the vendor-specific LQI.

A. Overview of the TPC Algorithm

The algorithm provides feedback control to maintain SINR above a reference value by adjusting the transmission power level. Its main features are:

- 1) estimation by the receiving node of the SINR of the communications link making use of (7);

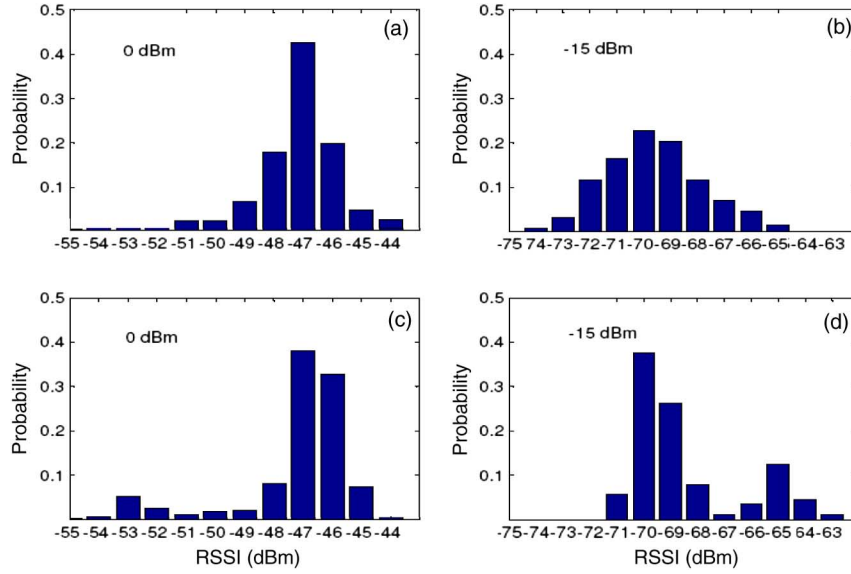

Fig. 4. RSSI distributions for different transmission power levels. *Upper*: (a) and (b) show channel 15. *Lower*: (c) and (d) show channel 24.

- 2) computation of the transmission power level required for achieving the reference SINR value;
- 3) generation by the receiving node of a TPC command;
- 4) feedback of a TPC command from the receiver to the transmitter. The aim of the feedback is to reduce the transmission power to the lowest value which gives adequate SINR.

Detailed steps in the algorithm include:

- 1) modeling the relationship between RSSI and transmission power at the receiver;
- 2) building a TPC table in the transmitting node;
- 3) making a TPC decision in order to determine whether a TPC command has to be forwarded to the transmitter;
- 4) adjustment of the transmission power level in the transmitter by means of a power update controller.

B. Building the TPC Table

The TPC table models the linear relationship between transmission power level and RSSI for each link and each channel. This model will be used to find the lowest value of transmission power required that will achieve the desired RSSI and, consequently, achieve the reference SINR. The algorithm establishes the TPC table during network setup making use of beacon packets which are transmitted periodically to announce the presence of the network. The table provides a relationship between transmission power and RSSI for all available communication links and channels. When a node has to transmit a packet, it consults the TPC table to identify the minimum transmission power required for communication with a specific node.

As each node may offer different levels of transmission power, let that be denoted by a vector \mathbf{T}_A

$$\mathbf{T}_A = \{\tau_{i=1}, \tau_2, \dots, \tau_N\} \quad (9)$$

where element τ_i represents a discrete transmission power available at node A denoted by index i . N is the number of available power levels.

A PRR test is used to find the linear relationship between the transmission power and RSSI. Each PRR test requires a few (e.g., 100) packets to be transmitted at a particular power level. For each received packet, a corresponding RSSI is recorded. The test is conducted using available transmission power levels starting from the maximum power level and proceeding toward lower levels. The test ends when the PRR value shows that the transmission power is too low for successful transmission. RSSI and PRR are represented by R_B and PRR_B computed at the receiving node B , respectively. Here $r_i(\tau_i)$ is the average RSSI value recorded at the receiver corresponding to packet transmitted at power level τ_i

$$\mathbf{R}_B = \{r_1(\tau_1), r_2(\tau_2), \dots, r_N(\tau_N)\} \quad (10)$$

$$\mathbf{PRR}_B = \{\text{pr}_1(\tau_1), \text{pr}_2(\tau_2), \dots, \text{pr}_N(\tau_N)\}. \quad (11)$$

Up to 16 channels may be available for communication between each transmitting and receiving node. Therefore, a matrix is formulated as follows:

$$R_B(k, \tau_i) = a_k \tau_i + b_k \quad (12)$$

$$11 \leq k \leq 26.$$

Here, k represents the channel number as defined by IEEE 802.15.4, and a_k and b_k are parameters describing the linear relationship between R_B and τ_i . A matrix is built and stored for all available pairs of nodes and used to determine the transmission power required to yield a specific RSSI value at the receiving node. This RSSI value depends on a user-specified reference SINR. The computed transmission power values are conveyed to the transmitter where they are stored in the TPC table in the power update controller as shown in Fig. 5.

Once the TPC table is in place, the TPC algorithm can select a suitable transmission power level for detailed evaluation. This requires 1000 packets per channel to determine the mean,

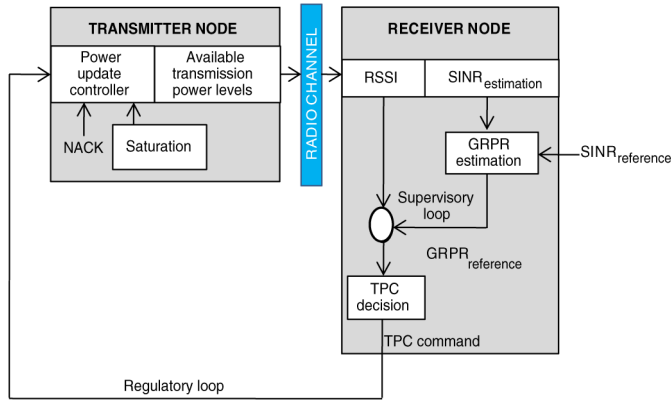

Fig. 5. Illustration of the TPC loops.

maximum, and minimum RSSI values and the RSSI values at the peak(s) of the distribution.

C. Estimation of Golden Receive Power Range

Fig. 5 presents the proposed TPC system. The receiving node estimates the SINR values for specified channels over a given period of time. The desired RSSI value is determined which can ensure good link quality based on the estimated and reference SINR values, and the fade margin. *Fading* refers to the variation which a communication signal experiences due to interference arising from multipath propagation, and *fade margin* is a design margin such that transmissions are sent at a higher power level to overcome fading. In the proposed algorithm, the range (max–min) of the RSSI as recorded between a pair of nodes is used in a fade margin calculation.

The proposed TPC algorithm adapts a concept from Bluetooth which specifies a range of RSSI values within which the operation of a pair of nodes is considered optimal [11]. The range is fixed in Bluetooth, whereas in this proposed algorithm this range is not fixed. It is estimated for each link and is dynamically adjusted. This range is referred here as golden receive power range (GRPR) and is estimated at the receiver. Based on the estimated SINR and SNR values obtained from (7) and (8), the receiving node determines an upper threshold G_U , and lower threshold G_L for each link. G_L is estimated such that the received RSSI can ensure the minimum required reference SINR under channel fading conditions and G_U represents the expected RSSI at the receiver without signal fading. Within the estimated GRPR, the operation of the transmitter is considered optimal and requires no adjustment. If the recorded RSSI at the receiver is outside the GRPR, then the transmission power must be adjusted.

In order to ensure the required SINR, a bias may be added in some channels. In particular, the GRPR thresholds G_L and G_U must both be set higher in channels with Wi-Fi interference. The bias added to the GRPR thresholds in channel i is $Pk_h(RSSI_i) - Pk(RSSI_j)$, where the Pk function returns the RSSI value at the peak of the distribution. Pk_h is the peak in a bimodal distribution with higher RSSI, i represents a channel with interference, and j represents a channel known to be free of interference.

D. Setting the Transmission Power Level

The transmitter in Fig. 5 aims to match the actual power of its transmitted signal to the required transmission power level determined at the receiver. Feedback is expected from the receiver if the RSSI value goes outside GRPR. The transmitter then adjusts the transmission power value accordingly. However, there are limitations imposed by standards and the hardware. First, there are minimum and maximum transmission power levels, indicated by the saturation block in Fig. 5. Moreover, only limited numbers of discrete power levels are available in the transmitter, dependent on the hardware. The available transmission power level which is nearest to the wanted value is selected. Transmission power is adjusted on per received packet basis. The update rate will, therefore, vary from milliseconds to seconds depending on the process being monitored or controlled.

The supervisory loop in the receiver node identifies the GRPR, as discussed. The objective of the regulatory loop between receiver and transmitter is to ensure that the RSSI value reported at the receiver is within the range of the GRPR. The supervisory loop needs to be executed only when the communicating nodes are relocated or when new interfering nodes appear. For a fixed installation, the SINR estimations and linear approximations are found to change only slowly and the regulatory loop is sufficient to compensate for changes in the link quality during normal operation.

There is a further procedure in place to address Negative ACKnowledgment (NACK). ACKnowledgment (ACK) is information provided in the IEEE 802.15.4 transmission protocol. If ACK is not active, it means the receiving node did not acknowledge the receipt of the transmitted packet. The usual action is to send the packet again, but persistent NACKS might indicate the presence of a new interference source or the relocation of communicating nodes. The response is an increase in transmission power while the TPC tables are updated.

E. Implementation of the TPC Algorithm

The majority of the processing for the TPC algorithm takes place at receiver, while the actuation takes place at the transmitter. The working of the proposed TPC can be divided into two phases: 1) *initialization phase*; and 2) *operational phase*. The flowcharts of the algorithms are shown in Figs. 6 and 7. The initialization phase involves the use of the supervisory loop and is responsible for building the TPC table and determining the GRPR. It begins by conducting the PRR tests, estimating the SINR values, and fitting the linear approximation to the transmission power and RSSI. Further, the GRPR is computed based on the estimated SINR values. The G_U value of GRPR is used to determine the required transmission power using the above-mentioned linear approximation. For each pair of nodes, the transmission power is computed at the receiver and conveyed to the transmitter where the TPC table is stored. During the operational phase, which involves only the use of the regulatory loop, only the received RSSI values are tracked and compared to GRPR, based on which TPC decisions are made.

A hardware-in-the-loop demonstration of the algorithm tested its practical adaptation to a link of variable distance subject to interference and fading. The PRR test procedures were programmed onto CC2430EM modules as shown in Fig. 2. The

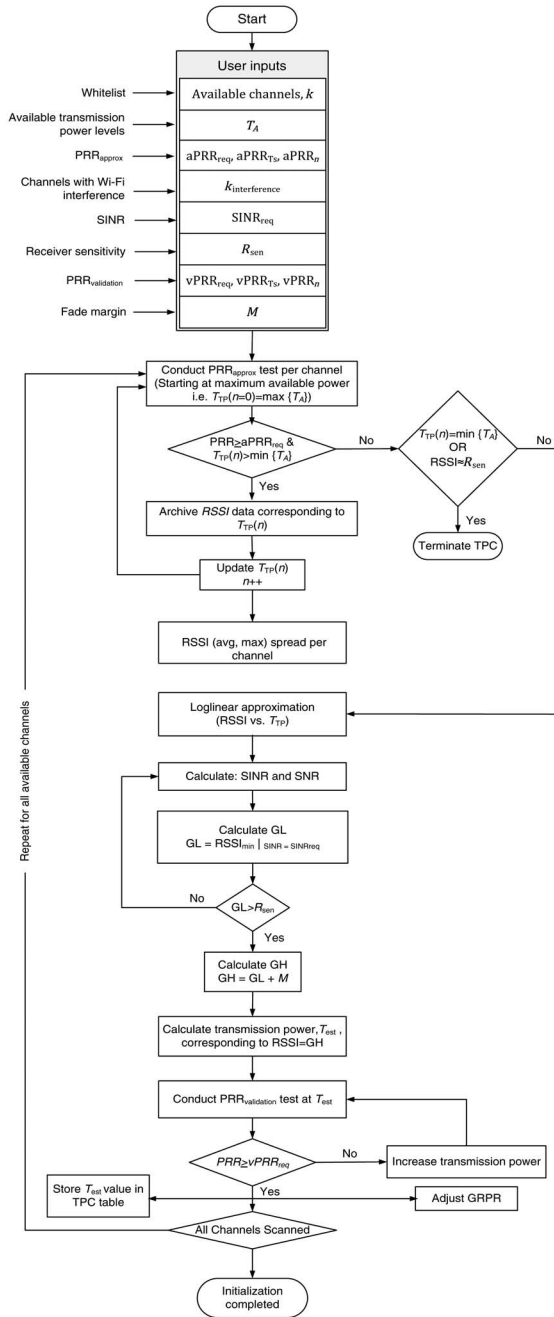

Fig. 6. Flowchart of the initialization phase of the AMC-TPC algorithm.

outcome of PRR tests and the recorded RSSI values of each packet were communicated to the computer. Estimation of the linear relationship between the transmission power and RSSI, and SINR was carried out at the computer using MATLAB. GRPR was then estimated and the outcome was conveyed back to the receiver. Further, the estimate of transmission power was sent to the transmitter. This configuration, therefore, implemented the initialization phase partly on the computers and partly on the CC2430EM modules while the operational phase was implemented on the CC2430EM modules.

F. Channel Assignment

The frequency hopping pattern is generated by the network manager and is a centrally controlled mechanism. During the

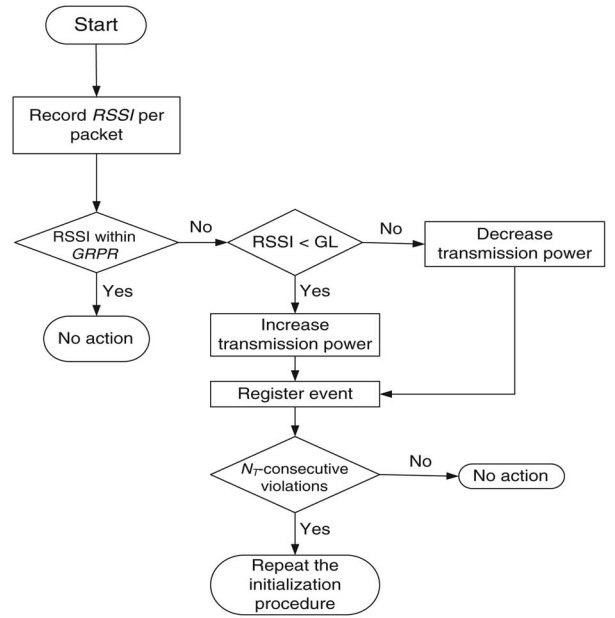

Fig. 7. Flowchart of the operational phase of the AMC-TPC algorithm.

TPC initialization, channels which are subjected to interference and have inadequate link quality are identified. In principle, the information can then be passed to the network manager and the poorly performing channels would be taken out of the frequency hopping pattern (i.e., black listing).

VI. EXPERIMENTAL RESULTS

A. Results From Initialization Phase

Fig. 8 (upper plot) shows the transmission power level selected by the transmitter. During the first 20 s, the transmitter conducts the PRR tests at two different power levels (100 packets at each of 0 and -5 dBm) in order to establish a linear relationship between transmission power and RSSI. The linear relationship permits extrapolation and selection of a transmission power level (-25 dBm) that is able to achieve the desired SINR at the receiver. If the PRR remained adequate, then the algorithm proceeds to determine the RSSI distribution and the GRPR. If the PRR was not adequate, the transmission power would have been increased to the next level. In fact, -25 dBm is the lowest available power transmission power level on the CC2430EM modules. The lower plot in Fig. 8 presents the received RSSI values at the receiver for channels 15 and 24. The RSSI recorded in channel 24 with interference was higher, as expected from earlier results.

VII. EVALUATION

A. Results From Operational Phase

The upper and lower plots on the left of Fig. 9 present the performance of transmitter and receiver for channel 15 during the operational phase. The regulatory control loop is executed when the received RSSI value goes outside the GRPR (-70 to -90 dBm, for channel 15). As a result of violation of the lower boundary condition due to channel fading, the transmitter was signaled to increase the transmit power three times in 5 h. After

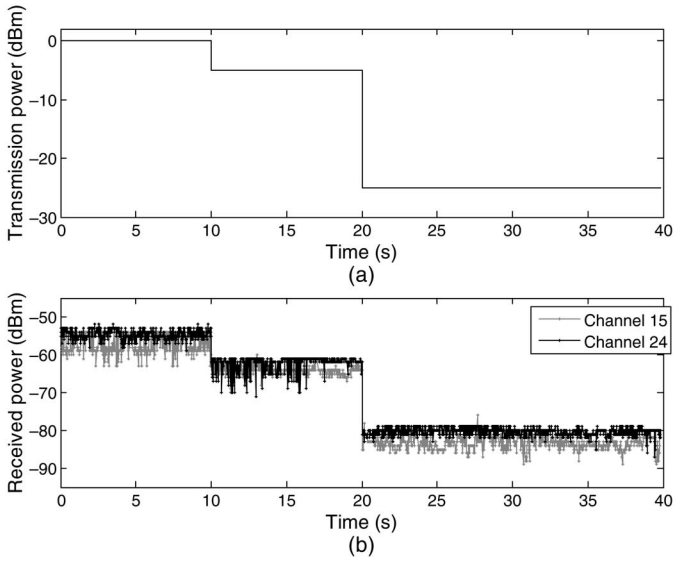

Fig. 8. (a) Transmission power. (b) RSSI at receiver.

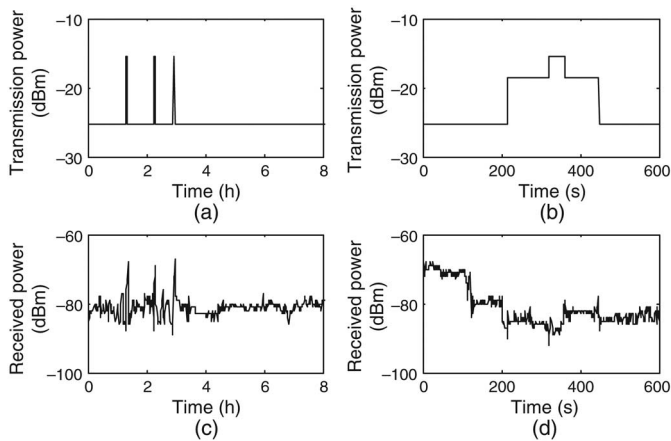

Fig. 9. Run-time operation. (a) and (c) transmission power responses to fading. (b) and (d) transmission power responses to changes in position of the receiver.

the third occasion, the removal of the cause of channel fading stabilized the transmission power at -25 dBm. The results show that GRPR calculated by the proposed TPC algorithm provides an effective response to fading.

Fig. 9 also shows an experiment using channel 24 in which the distance between transmitter and receiver was changed. The results show that the transmitted power was adjusted in order to keep the RSSI at the receiver within the GRPR. Until 200 s, the receiver was close to the transmitter. The RSSI at the receiver was high and the algorithm selected the minimum transmission power level of -25 dBm. The receiver moved away at around 100 s, and again at 200 s. On the second move, the RSSI went below the lower limit of the GRPR (-90 dBm) and the algorithm responded by increasing the transmission power to meet the SINR reference value. The same response can be seen on a move at 300 s. At 350 s, the receiver started to move back closer to the transmitter. The final move at 450 s highlights the effectiveness of the algorithm in power saving. When the receiver moved closer, the transmitter was able to reduce the transmitted power while keeping the RSSI within the GRPR.

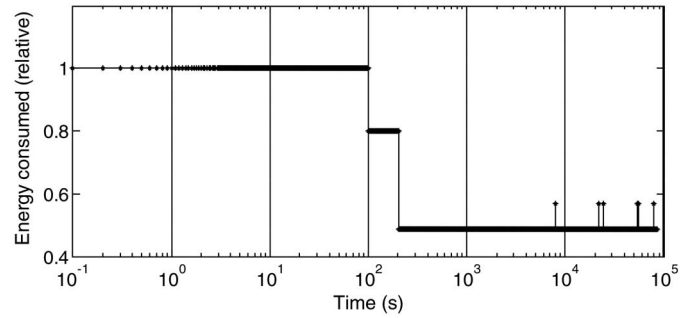

Fig. 10. Energy saving of AMC-TPC.

B. Energy Savings

1) *Experimental Demonstration:* Fig. 10 presents the outcome of an experiment to evaluate the performance of the proposed TPC algorithm in which the algorithm was left to operate for 1 day. In the experimental setup, the distance between the transmitter and the receiver was 2.5 m. The horizontal axis is elapsed time and is presented with a logarithmic scale so that activity in the first few minutes can be seen clearly. It is apparent from the experiment that the transmitter utilized higher transmission levels during the initialization phase of the algorithm and afterward it settled at a lower available transmission power level, hence reducing the energy consumption. The transmitter was able to successfully achieve the required reliability at a power level corresponding to the energy saving of more than 50%. However, during the 24-h window (up to 86 400 s), the algorithm adapted to changing environmental conditions and adjusted the transmission power level to compensate for channel fading. The spikes in the energy ratio are a result of the system being subjected to fading.

The graph in Fig. 10 represents transmission power at the transmitter. During the operational phase, the energy consumption at the receiver is negligible because RSSI is available from the hardware. Moreover, in simple networks using star topology each sensor communicates directly to the access point or gateway. In that case, the consumption at the receiver is irrelevant because the access point and gateway are likely to have a wired power supply. The setup cost during initialization is small, and is calculated in Section VII-B-2.

The experimental setup in Fig. 2 shows laptop computers running MATLAB. The energy consumption of the laptops in Fig. 2 is not related to the TPC algorithm during the operational phase. Their role is to generate packets of data for transmission, and to log the received data. During the operational phase, the laptop computers represent the physical plant and the hardware of the industrial control system in which the wireless network is embedded. For convenience, the laptop computers undertook certain calculations during the initialization phase. These were the estimation of the linear relationship between the transmission power and RSSI, and SINR. In a commercial TPC algorithm, these calculations would be done on board the CC2430EM modules during the first few seconds of the initialization phase. It is normally the case that the power needed to perform calculations on a CC2430EM module is much less than the power needed for transmission. Therefore, an estimate of the energy savings can be made by calculating the number of packet

transmissions needed in initializing and operating the TPC algorithm, as shown Section VII-B-2.

2) *Estimation of Energy Savings*: The total energy consumption at the transmitter with TPC implementation is calculated using transmission data, and is given by the following formula:

$$E_{\text{total}} = V_0 \left[t_{\text{op}} \sum_{j=\min}^{\max} N_j I_j + t_{\text{dp}} \sum_{k=\min}^{\max} N_k I_k \right] \quad (13)$$

where the first term on the right accounts for overhead introduced by the TPC algorithm and the second term takes into consideration the cost of data communications. Here, V_0 is the operating voltage, t_{op} is the time to transmit the TPC packet and similarly t_{dp} for data packet. Further, N_j represents the number of overhead packets generated during TPC initialization and the consumption of current I_j during packet transmission at j th power level. Subscript k represents the transmission level values during data transmission. E_{total} refers to energy consumption in one channel. The energy cost for operation over multiple channels would be an integer multiple of this overhead value, where the integer is equal to the number of available channels. The energy required for feedback via the regulatory loop from the receiver during the operational phase is negligible.

To estimate the energy cost of the proposed algorithm, a use case is considered which requires an update frequency of 1 Hz and packet sizes of 127 bytes. It is assumed that the initialization is required once per day, the PRR test comprises 100 packets at each power level, and the maximum number of channels is 15. Taking into consideration the energy expenditure with and without TPC, calculations show that if the algorithm finds a suitable power level to be -25 dBm (which corresponds to $I_k = 8.5$ mA in case of CC2420) or below then the cost of the overhead introduced by TPC can be compensated within 6 h of operation.

C. Scalability

The TPC algorithm has been designed to operate on a pair-wise basis between individual pairs of nodes. The same TPC algorithm can be applied to all the nodes in the network and it can compute the minimum transmission power required for each link. The TPC table which is built as a result of this algorithm contains information about the transmission power required for communication with any node which is within the communication range of a transmitting node. In any network, each wireless node maintains a collection of tables, such as a neighbor table which contains the list of nodes which the device can directly communicate with. The TPC table is an enhancement to this table with new columns specifying the transmission power required for communication with a specific node and at a given channel number. The TPC initialization is conducted once at startup when the network is formed. Afterward, when new nodes join, the neighbor table and the TPC table are updated. There will be only one TPC table per transmitting node and one power update controller. The memory and processing requirements are kept to minimum as the initialization is required only once and afterward requires only the tracking of RSSI. The use of TPC on a pair-wise basis helps to achieve topology-independency and scalability. It also removes the need for a central controller to coordinate the TPC operations.

TABLE III
COMPARISON OF ATPC AND AMC-TPC

	ATPC	AMC-TPC
Designed for industrial wireless standards	No	Yes
Overcoming interference	Not studied	Incorporated into the design
Link quality metrics	LQI, PRR, RSSI	PRR, RSSI and SINR
GRPR	Lower bound: based on PRR. Upper bound: selected to achieve energy trade-off	Calculated dynamically from SINR, PRR and a reference specified by user. Includes fade margin adjustment
Recommendation on how many packets to use for initialization	Given	Given

D. Comparison With ATPC

The algorithm presented here, AMC-TPC, was developed to implement TPC in the industrial wireless standards. These standards support TPC but do not specify how it should be implemented. They also have requirements such as support for multi-channel operations, reliability, availability, coexistence with Wi-Fi interference, adaptability to asymmetric links, varying transmission power levels, and sensitivity thresholds of the receiver. It would be desirable to make a comparison of the performance of AMC-TPC with another published TPC algorithm for WirelessHART or ISA100.11a, but there is little in the literature on which to base such a comparison since no other practical implementations has been reported to date.

As discussed earlier, AMC-TPC is based on ideas from [29] which presented adaptive transmission power control (ATPC) using the linear relationship between RSSI and link quality [29]. Both algorithms are effective in adapting transmission power levels to the link quality. ATPC was developed before the industrial wireless standards [1]–[3] were ratified and does not consider all of the industrial requirements. For instance, the effects of collisions and interference were not studied and were identified as future work in [29]. In the case of AMC-TPC, adaptation to interference has been incorporated in the design.

A qualitative comparison of ATPC and AMC-TPC is provided in Table III. Both algorithms make use of GRPR. In ATPC, the lower threshold of GRPR is based on PRR, such that it does not fall below a certain threshold value. The upper threshold is chosen to give a satisfactory trade-off between the energy saved in data transmission compared to the energy cost of transmitting overhead packets. The GRPR in AMC-TPC is calculated based on the SINR and PRR reference specified by the user, and is adjusted according to the link quality, interference, and fade margin on each link with each individual neighbor. The AMC-TPC algorithm also recommends how many packets should be used during the initialization phase to estimate RSSI and GRPR.

VIII. CONTRIBUTION OF THE WORK

A. Extension of the State of the Art in TPC

The AMC-TPC algorithm presented in this paper extends the current state of the art by providing a solution to the open problem of a TPC algorithm to meet the requirements of

TABLE IV
COMPARISON OF AMC-TPC WITH OTHER REPORTED TPC ALGORITHMS

Algorithm	Experiment	INSTRUMENTATION SPECIFIC REQUIREMENTS					Performance Indicators – metrics used	Recommendation on the number of packet to be used during the initialization phase
		Interference mitigation	Vendor independency (Industrial protocols considered)	Topology independency	Multi-channel operation	GRPR selection criteria		
AEWMA [34]	PC, Mica2 and emulator	Not explicit	Yes (No)	Yes	Not explicit	N/A ^a	SNR & RSSI	N/A
AMC-TPC	PC with CC2430	Studied & incorporated	Yes (Yes)	Yes	Yes	SINR, PRR and FM	PRR, RSSI & SINR	Given
ATPC [29]	MicaZ nodes	Not explicit	Yes (No)	Yes	Not explicit	PRR & energy trade-off	PRR & RSSI {LQI shown to work}	Given
Hybrid [34]	Mica2 motes	Not explicit	Yes (No)	Yes	Not explicit	N/A	Packet ACKs	No
LMA/LMN ^b [35][36]	Simulation (OMNet++)	Not explicit	Yes (No)	Yes ^c	Not explicit	N/A	Connectivity based {i.e. Packet ACKs}	N/A
MIAD PC/ Adaptive MIAD PC ^d [30, 31]	Telos motes	Not explicit	Yes (No)	Yes	Not explicit	N/A	PRR, RSSI ^e {can also use SINR}	N/A
ODTPC [47]	Mica2 motes	Not explicit	Yes (No)	Yes	Not explicit	RSSI, margin & reading error	RSSI	Given
PCBL [48]	PC104 testbed with Mica2	Not explicit	Yes (No)	Yes ^f	Not explicit	PRR & RSSI	PRR	No
PER PC [30, 31]	Telos motes	Assumed Negligible	Yes (No)	Yes	Not explicit	N/A	RSSI, PER & SINR	N/A

^aAEWMA uses exponentially weighted moving-average as a filter function.

^bLMN operation is similar to LMA except that it adds some information in the acknowledgment message.

^cIn LMN, the addition of neighbor's neighbor added to ACK will be a concern due to different routing and scheduling schemes used in industrial wireless protocols.

^{d,e}Adaptive MIAD PC uses adaptive step sizes to adjust the transmission power as opposed to fix size as in MIAD PC. Furthermore, it also uses RSSI to compute transmission power.

^fPacket-based blacklisting scheme. The term not explicit means either no reference to such an industrial requirement was highlighted or if it was mentioned then not considered during the formulation of the algorithm.

industrial instrumentation networks based on WirelessHART, ISA100.11a, or WIA-PA which employ slow and fast frequency hopping, with graph and source routing. AMC-TPC has taken these requirements into consideration, particularly the need for multi-channel operations and the importance of coexistence with a neighboring Wi-Fi network.

The work has included empirical and analytical studies.

Table IV shows a summary and comparison of TPC algorithms reported in literature for WSNs [29]–[31], [34]–[36], [47], [48]. The meanings of the column headings are as follows.

- 1) *Experiment*: How the algorithm was evaluated.
- 2) *Performance indicators*: The metrics for link quality assessment.
- 3) *Recommendation on the number of packet*: States if any fundamental principle was used to assign the number of packets to be used during the initialization stage of the algorithm.
- 4) *Interference mitigation*: States whether these TPC algorithms have explicitly considered the interference from co-channel Wi-Fi networks during the formulation of control strategy or have evaluated their performance when subjected to interference.

- 5) *Vendor independency*: The use of metrics which are hardware independent.
- 6) *Industrial protocols considered*: The industrial protocols are WirelessHART, ISA100.11a, and WIA-PA.
- 7) *Topology independency*: Support for pair-wise TPC implementation as opposed requiring infrastructure mode as is the case of cellular networks.
- 8) *Multi-channel operation*: Self-explanatory and highlights the fact the industrial protocols can operate over available channels in 2.4-GHz band.
- 9) *GRPR*: The criteria used for setting the GRPR limit.

The fourth column of Table IV shows that, other than AMC-TPC, none of the TPC algorithms addresses the needs of standardized industrial WSNs. The reasons may be found in the cited references and include:

- 1) use of MAC and networking protocols which do not comply with the standards for industrial application;
- 2) use of algorithms formulated for idealized link conditions;
- 3) assumption of symmetric links between pairs of communicating nodes;
- 4) assumption of negligible co-channel interference from a neighboring Wi-Fi;

- 5) results based on single channel operation;
- 6) in some cases, results based only on simulations.

The recommendations in this paper for interference mitigation and the initialization phase are novel features of the work. They are based on statistical measures that determine the optimum, as opposed to the use of an arbitrary fixed value.

The AMC-TPC algorithm has been implemented using a hardware in the loop test-bed comprising CC2430 nodes. The effectiveness of the proposed algorithm has been demonstrated through a systematic set of experiments which subjected the wireless link to interference, analyzed the effect on the link quality, and adjusted the transmission power as needed.

B. Quantitative Comparisons

A quantitative comparison of performance of the algorithms in Table IV has proved difficult because there is little published information. Ideally, as suggested by one of the reviewers, useful metrics for comparison would be reliability, energy efficiency, communication delay, complexity, and memory usage, which would all have to be evaluated under similar experimental conditions. The algorithms presented in [30] are evaluated in [31], but not in terms of these metrics. Other authors have reviewed specific metrics. For instance, experimental evaluation of the TPC algorithms reported by [49] compares PRR and battery consumption while [50] focuses on throughput, power consumption, neighbor distribution, and routing information.

The overall conclusion is that there is too little shared knowledge available to make a comparison between other algorithms and the performance of AMC-TPC.

These comments suggest that a valuable future contribution to the profession would be specifications for benchmarks tests to enable such comparisons to be made.

IX. CONCLUSION

An algorithm has been justified and presented in this paper for TPC for industrial wireless instrumentation. It is based on RSSI and PRR for link estimation. A linear approximation is assumed between the transmission power and RSSI. The algorithm comprises two phases. The initialization phase is responsible for setting the limits of operation for the RSSI values which satisfy the SINR criteria and the fade margin. During the operational phase, the algorithm considers whether the RSSI for the received packets falls within a GRPR. Violation of the GRPR triggers an external feedback loop which adjusts the transmission power.

The practicality and performance of the TPC algorithm were studied through empirical data collected from hardware-in-the-loop implementation. The experimental results show that the use of RSSI, PRR, and SINR estimation as proposed in the algorithm offer a good solution for TPC in practical deployments.

ACKNOWLEDGMENTS

The authors would like to thank the anonymous reviewers for their insightful comments and suggestions for improving the paper. They are also grateful to Trygve Harvei, ABB Norway, for advice, discussions, and commentary on the topic of the paper.

REFERENCES

- [1] *Industrial Communication Networks—Wireless Communication Network and Communication Profiles—WirelessHART*, IEC Standard 62591:2010, 2010.
- [2] *Wireless Systems for Industrial Automation: Process Control and Related Applications*, ANSI/ISA Standard 100.11a-2011, 2011.
- [3] *Industrial Communication Networks—Fieldbus Specifications—WIA-PA Communication Network and Communication Profile*, IEC/PAS Standard 62601:2009, 2009.
- [4] V. C. Gungor and G. P. Hancke, "Industrial wireless sensor networks: Challenges, design principles, and technical approaches," *IEEE Trans. Ind. Electron.*, vol. 56, no. 10, pp. 4258–4265, Oct. 2009.
- [5] A. Willig, "Recent and emerging topics in wireless industrial communications: A selection," *IEEE Trans. Ind. Informat.*, vol. 4, no. 2, pp. 102–124, May 2008.
- [6] A. Sheth and R. Han, "Adaptive power control and selective radio activation for low-power infrastructure-mode 802.11 LANs," in *Proc. 23rd Int. Conf. Distrib. Comput. Syst., IEEE Workshop Mobile Wireless Netw.*, May 19–22, 2003, pp. 812–818.
- [7] T. M. Chiwewe and G. P. Hancke, "A distributed topology control technique for low interference and energy efficiency in wireless sensor networks," *IEEE Trans. Ind. Informat.*, vol. 8, no. 1, pp. 11–19, Feb. 2012.
- [8] S. A. Callaghan, I. Inglis, and P. Hansell, "Impact of introducing automatic transmit power control in P-P fixed service systems operating in bands above 13 GHz," CCLRC Rutherford Appleton Lab., Harwell, Oxfordshire, U.K., Ofcom Contract 830000059, Final Rep., 2006.
- [9] A. Gjendemsjø, G. E. Oien, and P. Orten, "Optimal discrete-level power control for adaptive coded modulation schemes with capacity-approaching component codes," in *Proc. IEEE Int. Conf. Commun.*, Istanbul, Turkey, Jun. 11–15, 2006, pp. 5047–5052.
- [10] H. Holma and A. Toskala, Eds., *WCDMA FOR UMTS—HSPA Evolution and LTE*, 5th ed. Hoboken, NJ, USA: Wiley, 2010.
- [11] Bluetooth Special Interest Group. (2001). *Specification of the Bluetooth System, Specification volume 1* [Online]. Available: <http://www.bluetooth.com>
- [12] S. Lanzisera and K. S. J. Pister, "Theoretical and practical limits to sensitivity in IEEE802.15.4 receivers," in *Proc. 14th IEEE Int. Conf. Electron. Circuits Syst.*, Dec. 11–14, 2007, pp. 1344–1347.
- [13] S. K. Khangura, K. Kaur, and R. S. Uppal, "Power control algorithms in wireless communication," *Int. J. Comput. Appl.*, vol. 1, no. 12, pp. 82–87, 2010.
- [14] V. G. Douros and G. C. Polyzos, "Review of some fundamental approaches for power control in wireless network," *Comput. Commun.*, vol. 34, no. 13, pp. 1580–1592, 2011.
- [15] B.-S. Chen, C.-Y. Yang, and S.-Y. Li, "Adaptive two-loop power tracking control in CDMA systems with the utility optimization," *IEEE Trans. Wireless Commun.*, vol. 7, no. 4, pp. 1358–1368, Apr. 2008.
- [16] M. Goyal, S. Prakash, W. Xie, Y. Bashir, H. Hosseini, and A. Duresi, "Evaluating the impact of signal to noise ratio on IEEE 802.15.4 PHY-level packet loss rate," in *Proc. 13th Int. Conf. Netw.-Based Inf. Syst.*, Sept. 14–16, 2010, pp. 279–284.
- [17] K. Shuaib, M. Alnuaimi, M. Boulmalf, I. Jawhar, F. Sallabi, and A. Lakas, "Performance evaluation of IEEE 802.15.4: Experimental and simulation results," *J. Commun.*, vol. 2, no. 4, pp. 29–37, 2007.
- [18] K. Srinivasan, P. Dutta, A. Tavakoli, and P. Levis, "An empirical study of low-power wireless," *ACM Trans. Sensor Netw.*, vol. 6, no. 2, pp. 16–49, 2010.
- [19] S. Y. Shin, H. S. Park, and W. H. Kwon, "Mutual interference analysis of IEEE 802.15.4 and IEEE 802.11b," *Comput. Netw.*, vol. 51, no. 12, pp. 3338–3353, 2007.
- [20] G. Anastasi, M. Conti, and M. Francesco, "A comprehensive analysis of the MAC unreliability problem in IEEE 802.15.4 wireless sensor networks," *IEEE Trans. Ind. Informat.*, vol. 7, no. 1, pp. 52–65, Feb. 2011.
- [21] S. Lin, G. Zhou, K. Whitehouse, Y. Wu, J. A. Stankovic, and T. He, "Towards stable network performance in wireless sensor networks," in *Proc. 30th Int. IEEE Symp. Real-Time Syst.*, Dec. 1–4, 2009, pp. 227–237.
- [22] S. M. M. Alavi, M. J. Walsh, and M. J. Hayes, "Robust distributed active power control technique for IEEE 802.15.4 wireless sensor networks—A quantitative feedback theory approach," *Control Eng. Pract.*, vol. 17, no. 7, pp. 805–814, 2009.
- [23] K. Srinivasan and P. Levis, "RSSI is under appreciated," presented at Proc. 3rd Workshop Embedded Netw. Sensors, Harvard Univ., Cambridge, MA, USA, May 30–31, 2006.
- [24] Y. D. Lee, D.-U. Jeong, and H.-J. Lee, "Performance analysis of wireless link quality in wireless sensor networks," in *Proc. 5th Int. Conf. Comput. Sci. Conver. Inf. Technol. (ICCIT)*, 2010, pp. 1006–1010.

- [25] *Part 15.4: Wireless Medium Access Control (MAC) and Physical Layer (PHY) Specifications for Low-Rate Wireless Personal Area Networks (WPANs)*, IEEE Standard 802.15.4, 2006.
- [26] N. Baccour, A. Koubâa, L. Mottola, M. A. Zúñiga, H. Yousseff, C. A. Boano, and M. Alves, "Radio link quality estimation in wireless sensor networks: A survey," *ACM Trans. Sensor Netw.*, vol. 8, no. 34, pp. 1–33, 2012.
- [27] L. Tang, K. Wang, and Y. Huang, "Study of speed-dependent packet error rate for wireless sensor on rotating mechanical structures," *IEEE Trans. Ind. Informat.*, vol. 9, no. 1, pp. 72–80, Feb. 2013.
- [28] V. Shrivastava, D. Agrawal, A. Mishra, and S. Banerjee, "Understanding the limitations of transmit power control for indoor WLANs," in *Proc. 7th ACM SIGCOMM Conf. Internet Meas.*, San Diego, CA, USA, Oct. 24–26, 2007, pp. 351–364.
- [29] S. Lin, G. J. Zhang, G. Zhou, L. Gu, T. He, and J. A. Stankovic, "ATPC: Adaptive transmission power control for wireless sensor networks," in *Proc. 4th Int. ACM Conf. Embedded Netw. Sensor Syst.*, Nov. 1–3, 2006, pp. 223–236.
- [30] B. Z. Ares, P. G. Park, C. Fischione, A. Speranzon, and K. H. Johansson, "On power control for wireless sensor networks: System model, middleware component and experimental evaluation," in *Proc. IFAC Eur. Control Conf. [CDROM]*, Jul. 2–5, 2007.
- [31] P. G. Park, C. Fischione, and K. H. Johansson, "Experimental evaluation of power control algorithms for wireless sensor networks," in *Proc. 17th IFAC World Congr.*, Seoul, Korea, Jun. 6–11, 2007, pp. 619–624.
- [32] J.-P. Sheu, K.-Y. Hsieh, and Y.-K. Cheng, "Distributed transmission power control algorithm for wireless sensor networks," *J. Inf. Sci. Eng.*, vol. 25, no. 5, pp. 1447–1463, 2009.
- [33] D. N. M. Dang and C. S. Hong, "A SINR-based transmission power control for MAC protocol in wireless ad hoc networks," *IEEE Commun. Lett.*, vol. 16, no. 2, pp. 2016–2019, Dec. 2012.
- [34] L. H. A. Correia, D. F. Macedo, A. L. Santos, A. A. F. Loureiro, and J. S. Nogueira, "Transmission power control techniques for wireless sensor networks," *Comput. Netw.*, vol. 51, pp. 4765–4779, 2007.
- [35] M. Kubisch, H. Karl, A. Wolisz, L. C. Zhong, and J. Rabaey, "Distributed algorithms for transmission power control in wireless sensor networks," in *Proc. IEEE Wireless Commun. Netw. (WCNC)*, 2003, pp. 558–563.
- [36] I. Khemapech, A. Miller, and I. Duncan, "A survey of transmission power control in wireless sensor networks," in *Proc. 8th Annu. Postgrad. Symp. Conver. Telecommun. Netw. Broadcast. (PGNet'07)*, Jun. 2007, pp. 15–20.
- [37] V. Kawadia and P. R. Kumar, "Principles and protocols for power control in wireless ad hoc networks," *IEEE J. Sel. Areas Commun.*, vol. 23, no. 1, pp. 76–88, Jan. 2005.
- [38] O. Chipara, Z. He, G. Xing, Q. Chen, X. Wang, C. Lu, J. A. Stankovic, and T. Abdelzaher, "Real-time power-aware routing in sensor networks," in *Proc. 14th IEEE Int. Workshop Qual. Service (IWQoS)*, Jun. 19–21, 2006, pp. 83–92.
- [39] T. Chiwewe and G. Hancke, "A distributed topology control technique for low interference and energy efficiency in wireless sensor networks," *IEEE Trans. Ind. Informat.*, vol. 8, no. 1, pp. 11–19, Feb. 2012.
- [40] D. Chen, M. Nixon, and A. Mok, *WirelessHART—Real-Time Mesh Network for Industrial Automation*. Berlin, Germany: Springer-Verlag, 2010.
- [41] S. Hellan and O. Stengel. (2005). "CC1020/1021 received signal strength indicator," *Application Note AN030, Chipcon Products from Texas Instruments* [Online]. Available: <http://www.ti.com/lit/an/swra062/swra062.pdf>, accessed on July 15, 2012.
- [42] Analog Devices. (2010). *ADF7242: Low Power IEEE 802.15.4/Proprietary GFSK/FSK Zero-IF 2.4 GHz Transceiver IC* [Online]. Available: http://www.analog.com/static/imported-files/data_sheets/ADF7242.pdf
- [43] Texas Instruments. (2006). *CC2420: 2.4 GHz IEEE 802.15.4 / ZigBee-ready RF Transceiver* [Online]. Available: <http://www.ti.com/lit/ds/symlink/cc2420.pdf>
- [44] M. M. A. Hossian, A. Mahmood, and R. Jäntti, "Channel ranking algorithms for cognitive coexistence of IEEE 802.15.4," in *Proc. 20th Int. IEEE Symp. Pers. Indoor Mobile Radio Commun.*, Sept. 13–16, 2009, pp. 112–116.
- [45] L. Lo Bello and E. Toscano, "Coexistence issues of multiple co-located IEEE 802.15.4/ZigBee networks running on adjacent radio channels in industrial environments," *IEEE Trans. Ind. Informat.*, vol. 5, no. 2, pp. 157–167, May 2009.
- [46] T. M. Cover and J. A. Thomas, *Elements of Information Theory*. 2nd ed. Hoboken, NJ, USA: Wiley, 2006.
- [47] J. Kim, S. Chang, and Y. Kwon, "ODTPC: On-Demand transmission power control for wireless sensor networks," in *Proc. Int. Conf. Inf. Netw.*, Busan, Korea, Jan. 23–25, 2008, pp. 1–5.
- [48] D. Son, B. Krishnamachari, and J. Heidemann, "Experimental study of the effects of transmission power control and blacklisting in wireless sensor networks," in *Proc. 1st Annu. IEEE Commun. Soc. Conf. Sensor Ad Hoc Commun. Netw.*, Oct. 4–7, 2004, pp. 289–298.
- [49] M. Raza, G. Ahmed, and N. M. Khan, "Experimental evaluation of transmission power control strategies in wireless sensor networks," in *Proc. Int. Conf. Emerg. Technol. (ICET)*, Oct. 8–9, 2012, pp. 1–4.
- [50] J. Jeong, D. Culler, and J.-H. Oh, "Empirical analysis of transmission power control algorithms for wireless sensor networks," in *Proc. 4th Int. Conf. Netw. Sensor Syst.*, Jun. 6–8, 2007, pp. 27–34.

Waqas Ikram (M'13) received the M.Eng. degree in electronic engineering from the University College of London, London, U.K., in 2008, and the Ph.D. degree from the Department of Chemical Engineering, Imperial College of London, London, U.K., in 2013.

He is a Research Engineer at ABB Process Automation, Oil, Gas, and Petrochemicals, Oslo, Norway. His research interests include wireless sensor networks and wireless process control.

Stig Petersen (SM'13) received the M.Sc. degree in electrical engineering from the Norwegian University of Technology and Science, Trondheim, Norway, in 2000, and the Ph.D. degree from the Department of Mathematics and Computer Science, University of Antwerp, Belgium, in 2013.

He is a Research Scientist in the Department of Communication Systems, SINTEF ICT, Trondheim. He is currently the Manager of the WiCon project funded by the Research Council of Norway. His research interests include industrial wireless sensor networks.

Pål Orten received the M.Sc. degree in telecommunications from the Norwegian University of Technology and Science, Trondheim, Norway, in 1989, and the Ph.D. degree in wireless communications from Chalmers University of Technology, Göteborg, Sweden, in 1999.

He is the Director of the ABB Corporate Research Center, Billingstad, Norway. He also holds a part-time position as a Professor in Wireless Communications at the University of Oslo, Oslo, Norway. His research interests include channel coding, code division multiple access, multiuser detection, multiple-input multiple-output, and channel adaptation systems with application to satellite systems, cellular systems, wireless access systems, and industrial wireless sensor networks.

Nina F. Thornhill (SM'93) received the B.A. degree in physics from Oxford University, Oxford, U.K., in 1976; the M.Sc. degree in control systems from Imperial College London, in 1982; and the Ph.D. degree in 2005.

She is a Professor in the Department of Chemical Engineering, Imperial College London, where she occupies the ABB Chair of Process Automation. Her research interests include industrial data analysis with applications in oil and gas, chemicals, and electricity transmission.